



(541) 772-4372

132 WEST MAIN STREET, SUITE 101

MEDFORD, OREGON 97501

www.oregonarchitecture.biz

Proposed new construction of a convenience store with twelve (12) gas pump stations.

Current address: 29760 SW Boones Ferry Rd., Wilsonville, OR 97070

Acreage: .69 acres; 29,605 sq.ft.

Building GSF:3,100 GSF

Tax lots: 31W14D00900

Current Zoning: PDC – Planned Development Commercial

APPLICANT STATEMENT

September 7, 2021

Revised May 5, 2022: changes are indicated by Italic typeface

Summary of Proposal:

This project is located on .69 acres, of vacant land. The project site is bounded by Boones Ferry Road to the west and Interstate 5 off-ramp to the east. There is existing development to the north and south. There are no existing trees *within the center of the site. There are trees on the adjoining property to the south at both the east and west ends. These trees are outside the development perimeter will be able to remain. There are two maple trees in the northwest corner of the site that must be removed to accommodate the required public sidewalk.*

The development will include a 2,999 sq. ft. convenience store with a 12-gas pump station with canopy. The existing entrance from Boones Ferry Road *on the property to the south will provide access to the proposed development; no new driveways are proposed.* The convenience store will be V-B construction. A drive thru window will be installed on the west elevation. *The primary purpose of this drive-up window will be to facilitate the purchase of convenience store items. It is not intended to facilitate the delivery of food items. Those items will only be available for purchase from inside the store. That small change would also require additional staff, which is not in the owner's business plan.*

The site circulation has been revised to one way, with entrance at the east and exit to the west onto the adjacent parcel. We believe that will eliminate conflicts at the drive-through lane and at the site exit onto Boones Ferry Road. We also believe it will eliminate potential cross-traffic conflicts at the west site egress point.

A new sidewalk will be constructed along the Boones Ferry frontage, as per City requirements. Pedestrian access to the building will be from this sidewalk to the front entrance of the Convenience Store. This is the most direct route to the building from the public way. This route must cross the drive-thru lane twice, but to enhance pedestrian safety where this conflict exists we are proposing a different paving material at the crossings, and we typically elevate the surface so autos are aware that pedestrians have the right-of-way at this location.

The parking available on site does *meets the minimum and maximum City requirements, when the spaces at the pumps are included, as allowed by City Development Code.*



The existing utilities are developed beyond the project site, requiring little work *within* the street right-of-way. The existing overhead electrical lines are being reviewed by the power company to determine if there are required to be underground for the length of the project site. The overhead electrical lines extend beyond the project site to the north and south. There are no restrictions from Oregon Department of Transportation concerning the off-ramp from Interstate 5 adjoining the property.

The project will include a fuel price sign *along Boone's Ferry Road, a pylon sign limited to 20 feet in height along the Interstate 5 property line, and signage on the building and the canopy over the fuel pumps. The signage is addressed within the Signage Application, which is part of this application package.*

Discussion of key issues:

From the pre-application conference, one comment indicated any signs on the project site is limited to 20 feet in height. The developer accepts the 20 foot limit. *We have applied for a waiver for the fuel price sign.*

Another comment from the pre-application conference indicated the city would not allow a new driveway access to Boones Ferry Road from the project site. The City was in agreement that the driveway on the adjacent property will provide adequate access to the site.

There was a comment concerning the overhead power lines along the frontage of the project site. The city development code requires new development to provide utilities underground. The project team is in the process of coordinating with the power company on whether the overhead lines existing can or should be underground for the length of the project property.

There was a comment concerning the Right-of-Way along Boones Ferry Road, with the Engineering Department from the City indicating the ROW varies between 64 and 66 feet. The project team *has verified the width of the existing ROW and has revised the project base drawings, which now show a planter strip along the curb and a sidewalk behind it. The property owner will dedicate the land under those two improvements as part of the City ROW.*

After the pre-application conference, a Traffic Study was completed *by the City.*

The contracted garbage hauler has reviewed and accepted the Schematic Site Plan. Please see attached letter.

Code Criteria

APPLICABLE SECTIONS OF THE WILSONVILLE DEVELOPMENT CODE CHAPTER 4

Section 4.116 – Commercial Development Standards in All Zones

(.10) – Commercial developments generally

- A. No structure shall be erected closer than the right of way line then existing or the officially planned right of way of any public, county, or state road.*
- B. Minimum Front Yard Setback: None required except when front yard abuts a more restrictive district.*
- C. Minimum Rear Yard Setback: None required except when rear yard abuts a more restrictive district.*
- D. Minimum Side Yard Setback: None required except when side yard abuts a more restrictive district.*

- E. Maximum building height: Thirty-five (35) feet, unless taller buildings are specifically allowed in the zone.*
- F. Minimum Lot Size: No limitations, save and except as may otherwise be affected by other provisions of this Code.*
- G. Maximum Lot Coverage: No limitation, save and except as may otherwise be affected by other provisions of this Code.*
- H. Minimum Street Frontage: No limitation, save and except as may be necessary to provide minimum access requirements.*

Section 4.118 – Standards Applying to All Planned Development (PD) Zones

(.01) – Height Guidelines – In “S” overlay zones, the solar access provisions of Section 4.137 shall be used to determine maximum building heights.

- **The proposed project is not located in the “S” overlay zone, this section does not apply.**

(.02) Underground utilities shall be governed by Sections 4.300 to 4.320. All utilities above ground shall be located so as to minimize adverse impacts on the site and neighboring properties.

- **The proposed project will keep existing above ground and underground utilities in place, except as required by Section 4.300 to 4.320, where burying existing overhead utilities are required and approved by appropriate utility company.**

(.07) Density Transfers

- **The proposed project does not have housing density, this section does not apply.**

(.08) Wetland Mitigation and other mitigation for lost or damaged resources

- **The proposed project does not impact a resource area. This section does not apply.**

(.09) Habitat-Friendly Development Practices

A. Minimizing grading, removal or native vegetation, disturbance and removal of native soils and impervious areas.

- **The proposed site is a vacant lot, with little vegetation existing. All existing trees will remain in place. While impervious surfaces will be installed, 19% of the site will be vegetated with low water, low maintenance ground cover and landscaping.**

Section 4.131 – Planned Development Commercial (PDC) Zones

(.01) The following shall apply to any PDC zone:

A. Uses that are typically permitted:

1. Retail business, goods and sales

(.02) Prohibited Uses

- **The proposed project’s use is permitted from (.01) A and is not prohibited from (.02).**

Section 4.140 – Planned Development Regulations

(.03) Ownership

- A. *The tract or tracts of land included in a proposed Planned Development must be in one (1) ownership or control or the subject of a joint application by the owners of all the property included. The holder of a written option to purchase, with written authorization by the owner to make applications, shall be deemed the owner of such land for the purposes of Section 4.140*

(.04) Professional Design

- A. *The applicant for all proposed Planned Developments shall certify that the professional services of the appropriate professionals have been utilized in the planning process for development.*
- B. *Appropriate professionals include, but not be limited to the following to provide the elements of the planning process set out in Section 4.139*
- 1. An architect licensed by the State of Oregon*
 - 2. A landscape architect registered by the State of Oregon*
 - 3. An urban planner holding full membership in the American Institute of Certified Planners, or a professional planner with prior experience representing clients before the Development Review Board, Planning Commission, or City Council; or*
 - 4. A registered engineer or a land surveyor by the State of Oregon.*
- C. *One of the professional consultants chosen by the applicant from either 1,2, or 3, above shall be designated to be responsible for conferring with the planning staff with respect to the concept and details of the plan.*

- **The proposed project's team includes a licensed architect, landscape architect and registered engineer. The project's scope too small to require an urban planner. The architect is experienced with public bodies in the review process. The architect will be designated to be the contact between the applicant and the planning staff.**
- **Mark McKechnie, Licensed Architect; (541) 772-4372; mark@oregonarchitecture.biz**
- **Megan Morgan, Project Manager; (541) 772-4372, megan@oregonarchitecture.biz**

(.05) Planned Development Permit Process

- A. *All parcels of land exceeding two (2) acres in size that are to be used for residential, commercial or industrial development, shall prior to the issuance of any building permit:*

- **The proposed project is under the 2-acre requirement. This section does not apply.**

- D. *All planned developments require a planned development permit. The planned development permit review and approval process consists of the following multiple stages, the last two or three of which can be combined at the request of the applicant.*

- 1. Pre-application conference with the Planning Department*
- 2. Preliminary (Stage I) review by the Development Review Board or the Planning Director for properties within the Coffee Creek Industrial Design Overlay District.*
- 3. Final (Stage II) review by the Development Review Board or the Planning Director for properties within the Coffee Creek Industrial Design Overlay District.*

- **The proposed project completed the pre-application conference December 17, 2020. The applicant requests a Stage 2 review of this application and Site Design Review be combined.**
- **This application covers the requirements of the Stage 2 and Site Design Reviews.**

(.07) Preliminary Approval (Stage One)

- A. *An applicant for a Stage I approval shall be considered by the Development Review Board as follows:*
- 1. Be made by the owner of all affected property or the owner's authorized agent; and*
 - 2. Be filed on a form prescribed by the City Planning Department and filed with said Department*
 - 3. Set forth the professional coordinator and professional design team as provided in subsection (.04) above*
- B. *The application shall include conceptual and quantitatively accurate representations of the entire development sufficient to judge the scope, size, and impact of the development on the community*

- **The requirements of this section are located on the application drawings, including the survey, and calculations for land area for various designations. There is only one use on this site.**
- **The applicant requests that the Stage 2 review of this application and Site Design Review be combined.**
- **This application covers the requirements of the Stage 2 and Site Design Reviews.**

C. *An application for a Stage I approval shall be considered by the Development Review Board as follows:*

- 4. A final decision on a complete application and preliminary plan shall be rendered within one hundred and twenty (120) days after the application is deemed complete unless a continuance is agreed upon by the applicant and the appropriate City decision-making body.*

(.09) Final Approval (Stage Two)

D. *The final plan shall be sufficiently detailed to indicate fully the ultimate operation and appearance of the development or phase of development. However, Site Design Review is a separate and more detailed review of proposed design features, subject to the standards of Section 4.400*

- **The applicant requests that the Stage 2 review of this application and Site Design Review be combined.**
- **This application covers the requirements of the Stage 2 and Site Design Reviews.**

F. *Within thirty (30) days after the filing of the final development plan, the Planning staff shall forward such development plan and the original application to the Tualatin Valley Fire and Rescue District, if applicable, and other agencies involved for review of public improvements, including streets, sewers and drainage. The Development Review Board or Planning Director, as applicable, shall not act on a final development plan until it has first received a report from the agencies or until more than thirty (30) days have elapsed since the plan and application were sent to the agencies, whichever is the shorter period.*

- **The applicant requests that the Stage 2 review of this application and Site Design Review be combined.**
- **This application covers the requirements of the Stage 2 and Site Design Reviews.**

Section 4.154 – On-site Pedestrian Access and Circulation

B.1 Continuous Pathway System. A pedestrian pathway system shall extend through the development site and connect to adjacent sidewalks

B-2 Safe, Direct and Convenient. Pathways within the development shall provide safe, reasonably direct and convenient connections between primary building entrances and all adjacent parking areas.

B-3. Vehicle/Pathway Separation. Except as required for sidewalks...it shall be vertically or horizontally separated from the vehicular lane. Pathway is raised vertically 6 inches above abutting travel lane.

B-4. Crosswalks. Where a pathway crosses a parking area or driveway, it shall be clearly marked with contrasting paint or paving materials.

B-5. Pathway width and surface. Primary pathways shall be constructed of concrete, asphalt, brick/masonry pavers, or other durable surface and not less than (5) feet wide.

- ***Proposed project will provide direct, safe access from adjacent public sidewalk to the building. Crosswalks will be clearly marked. Crosswalk area will be raised and will be constructed of a contrasting material to provide an additional measure of identification and safety.***

Section 4.155 – Parking, Loading, and Bicycle Parking

(.02) – General Provisions

A. Waivers to the parking, loading or bicycle parking standards shall only be issued upon a finding that the resulting development will have no significant adverse impact on the surrounding neighborhood, and the community, and that the development considered as a whole meets the purpose of this section.

- ***Proposed project meets the minimum/maximum parking on site and does not need to request a waiver to the parking standards.***
- B. No area shall be considered a parking space unless it can be shown that the area is accessible and usable for that purpose, and has maneuvering area for the vehicles as determined by the Planning Director.*
- ***Parking under the canopy at the gas station pumps meet all the required clearances so they can be counted as site parking spaces. The site meets the minimum/maximum parking requirements.***

F. Off-street parking spaces existing prior to the effective date of this Code may be included in the amount necessary to meet the requirements in case of subsequent enlargement of the building or use to which such spaces are necessary.

- ***No shared parking is required.***

(.03) – Minimum and Maximum Off-Street Parking Requirements

A. Parking and loading or delivery areas and circulation shall be designed with access and maneuvering area adequate to serve the functional needs of the site.

- ***The Application package includes a truck turning diagram showing the operation of a fuel supply truck to/from Boones Ferry Road and through the site. The diagram has been prepared by a licensed Engineer.***

- B. *Parking and loading or delivery areas shall be landscaped to minimize the visual dominance of the parking or loading area*
1. *Landscaping of at least ten percent (10%) of the parking area designed to be screened from view from the public right-of-way and adjacent properties. This landscaping shall be considered to be part of the fifteen percent (15%) total landscaping required in Section 4.176.03 for the site development.*
 2. *Landscape tree planting areas shall be a minimum of eight (8) feet in width and length and spaced every eight (8) parking spaces or an equivalent aggregated amount.*
- D. *Where possible, parking areas shall be designed to connect with parking areas on adjacent sites so as to eliminate the necessity for any mode of travel of utilizing the public street for multiple accesses or cross movements.*

- ***Project site is too small to require a loading and delivery area separate from customer and employee parking. This project will interconnect with the adjacent lot. The project will also be sharing the entrance of the adjacent lot as the access point, reducing the number of entrances along Boones Ferry Road.***

G. *Tables 5 shall be used to determine the minimum and maximum parking standards for various land uses.*

- **The project is classified as e. Commercial; 1. Retail store except supermarkets and stores selling bulky merchandise and grocery stores 1500 sq. ft. gross floor area or less.**
- **The calculation for minimum parking: 4.1 parking spaces per 1000 sq. ft.**
- **The proposed convenience store is $2,999 \text{ sq. ft.}/1,000 = 3.0 \times 4.1 = 12.3$ or 13 parking spaces.**
- **The calculation for maximum parking: 6.2 parking spaces per 1,000 sq. ft.**
- **The proposed convenience store is $2,999 \text{ sq. ft.}/1,000 = 3.0 \times 6.2 = 18.6$ or 19 parking spaces.**
- **The proposed project will have 12 parking spaces at the gas pumps, plus 6 new parking spaces equals 16 parking spaces, which is within the allowable range.**

(.04) – *Standards for Required Bicycle Parking*

A. *Required Bicycle Parking – General Provisions*

1. *The required minimum number of bicycle parking spaces for each use category is shown in Table 5, Parking Standards.*

- **Table 5 calculation is: 1 bicycle space per 4,000 sq. ft. or Minimum of 2. The proposed project is less than 4,000 sq. ft., 2 bicycle spaces will be provided.**

Section 4.156.01. Sign Regulations Purpose and Objectives.

- A. *Well-designed and aesthetically pleasing signs sufficiently visible and comprehensible from streets and rights-of-way that about a site as to aid in wayfinding, identification and provide other needed information.*
- B. *Sign design and placement that is compatible with and complementary to the overall design and architecture of a site, along with adjoining properties, surrounding areas, and the zoning district.*

- C. *A consistent and streamlined sign review process that maintains the quality of sign development and ensures due process.*
- D. *Consistent and equitable application and enforcement of sign regulations.*
- E. *All signs are designed, constructed, installed, and maintained so that public safety, particularly traffic safety, are not compromised.*
- F. *Sign regulations are content neutral.*

The project proposes the following signs: one freestanding pylon sign along the I-5 frontage. The pylon shall be a maximum of 20 feet tall and the sign face shall be within the limits allowed by the Development Code. The sign face will be internally lit, and it will contain an electronic reader board for the fuel price.

There will be a monument sign on the Boones Ferry frontage. It will be a maximum of 5 feet 6 inches tall and will have an electronic message reader to indicate the price of fuel. Its overall size will be within the limits allowed by the Development Code. It will be internally lit.

There will be signage on all four sides of the Family Mart building. The signage will be individual letters and they will be internally lit. The fuel canopy will have the gas company logo, internally lit, but will not have any lettering.

A full Class III signage application has been included with this Development Approval Application.

Section 4.156.02 Sign Review Process and General Requirements.

(.06) Class III Sign Permit. Sign permit requests shall be processed as a Class III Sign Permit when associated with new development, except as noted in Subsection 4.156.02 (.05) C., or redevelopment requiring DRB review, and not requiring a Master Sign Plan; when a sign permit request is associated with a waiver or non-administrative variance; or when the sign permit request involves one or more freestanding or ground mounted signs greater than eight (8) feet in height in a new location.

We have requested a waiver for the electronic reader for fuel price information for the pylon sign, noted as WAIV22-0002.

Section 4.171 – General Regulations – Protection of Natural Features and Other Resources

(.02) – General Terrain Preparation

- A. *All developments shall be planned, designed, constructed and maintained with maximum regard to natural features and topography, especially hillside areas, floodplains and other significant landforms.*
- B. *All grading, filling and excavating done in connection with any development shall be in accordance with the Uniform Building Code.*

- **The proposed project will follow the requirements of the Uniform Building Code. This proposed project will minimize as much as possible the impact on the terrain.**

(.03) – Hillsides

- **This section does not apply to this project.**

(.04) – Trees and Wooded Areas

A. All developments shall be planned, designed, constructed and maintained so that:

- 1. Existing vegetation is not disturbed, injured, or removed prior to the site development and prior to an approved plan for circulation, parking and structure location.*
- 3. Existing trees are preserved within any right-of-way when such trees are suitably located, healthy and when approved grading allows.*

- **The proposed project will retain and protect the existing tree at the Boones Ferry entrance and the tree east of the east entrance to the site. The 2 existing trees at the northwest corner of the property will interfere with the new sidewalk and will therefore need to be removed.**

(.05) – High Voltage Powerline Easements and Rights of Way and Petroleum Pipeline Easements

B. Any proposed non-residential development within high voltage powerline easements and rights of way and petroleum pipeline easements shall be coordinated with and approved by the Bonneville Power Administration, Portland General Electric Company or other appropriate utility, depending on the easement or right of way ownership.

- **The proposed project will coordinate with Portland General Electric regarding burying non high voltage powerlines within an easement coordinated with Portland General Electric.**

Section 4.176 Landscaping, Screening and Buffering

(.02) – Landscaping and Screening Standards

A. Subsections “C” through “I”, below, state the different landscaping and screening standards to be applied throughout the city.

- **This section will be addressed with the Landscape Plan included in this application package.**

Section 4.175 – Public Safety and Crime Prevention

(.04) – Exterior lighting shall be designed and oriented to discourage crime.

- **The proposed project will utilize site lighting to illuminate the area to reduce crime.**

Section 4.177 – Street Improvement Standards

(.02) – Street Design Standards

A. All street improvements and intersections shall provide for the continuation of streets through specific developments to adjoining properties or subdivision.

- **The proposed project will be utilizing an existing adjacent entrance for access.**

B. The City Engineer shall make the final determination regarding right-of-way and street element widths using the ranges provided in Chapter 3 of the Transportation System Plan and the additional street design standards in the Public Works Standards.

- ***The City Engineer has reviewed the site and existing Right-of-Way width. The revised stie plan shows a planter strip and***

E. Corner or clear vision area

1. *A clear vision area which meets the Public Works Standards shall be maintained on each corner of the property at the intersection of any two streets, a street and a railroad or a street and a driveway.*

- **The proposed project will utilize the existing entrance on the adjacent lot. This entrance meets the clear vision requirements.**

.03 – Sidewalks

- A. Sidewalk widths shall include a minimum through zone of at least five feet.

- **The proposed project will include sidewalks no less than five feet.**

.08 – Access Drive and Driveway Approach Development Standards

- A. *An access drive to any proposed development shall be designed to provide a clear travel lane free from any obstructions.*

- **The proposed project will utilize the existing access drive on the adjacent lot. This access drive will remain as is.**

Section 4.179 – Mixed Solid Waste and Recyclables Storage in New Multi-Unit Residential and Non-Residential Buildings.

(.01) – All site plans for multi-unit residential and non-residential buildings submitted to the Wilsonville Development Review Board for approval shall include adequate storage space for mixed solid waste and source separated recyclables.

(.07) – The applicant shall work with the City’s franchised garbage hauler to ensure that site plans provide adequate access for the hauler’s equipment and that storage area is adequate for the anticipated volumes, level of service and any other special circumstances which may result in the storage area exceeding its capacity. The hauler shall notify the City by letter of their review of site plans and make recommendations for changes in those plans pursuant to the other provisions of this sections.

- **See attached letter from Republic Services approving Site Plan for trash services.**

Section 4.199 Outdoor Lighting

Section 4.199.10 – Outdoor Lighting in General

(.01) –Purpose.

- *The proposed project will adhere to the requirements of this section concerning outdoor lighting.*

Section 4.199.20 – Applicability

(.02) – Exemptions

- A. Interior lighting
- B. Internally illuminated signs
- C. Externally illuminated signs
- F. Building Code required path lighting
- K. Code required signs
- M. Landscape lighting

- **The proposed project will not have any lighting other than the above lighting installed on the site.**

Section 4.199.30 – Lighting Overlay Zones

(.02) – *The Lighting Zones shall be:*

- C. LZ 3 – *Medium to high density suburban neighborhoods and suburban commercial districts, major shopping and commercial districts as depicted on the Lighting Overlay Zone Map.*

Section 4.199.40 – Lighting Systems Standards for Approval

(.01) – *Non-residential Uses and Common Residential Areas*

- A. *All outdoor lighting shall comply with either the Prescriptive Option or the Performance Option below.*
- B. *Prescriptive Option*
 1. *The maximum luminaire lamp wattage and shielding shall comply with Table 7*
 2. *Except for those exemptions listed in Section 4.199.20(.02), the exterior lighting for the site shall comply with the Oregon Energy Efficiency Specialty Code, Exterior Lighting.*
 3. *The maximum pole or mounting height shall be consistent with Table 8*
 4. *Each luminaire shall be set back from all property lines at least 3 times the mounting height of the luminaire:*
 - a. *Exception 1: If the subject property abuts a property with the same base and lighting zone, no setback from the common lot lines is required.*

- **The proposed project will include exterior outdoor lighting meeting the requirements above. The manufacturer’s product information is included in the application package.**

Section 4.199.50 – Submittal Requirements

(.01) – *Applicants shall submit the following information as part of the DRB review or administrative review of new commercial, industrial, multi-family or public facility projects:*

- A. *A statement regarding which of the lighting methods will be utilized, prescriptive or performance, and a map depicting the lighting zones for the property.*
- B. *A site lighting plan that clearly indicates intended lighting by type and location. For adjustable luminaires, the aiming angles or coordinates shall be shown.*
- C. *For each luminaire type, drawings, cut sheets or other documents containing specifications for the intended lighting including but not limited to, luminaire description, mounting, mounting height, lamp type and manufacturer, lamp watts, ballast, optical system/distribution, and accessories such as shields.*
- D. *Calculations demonstrating compliance with Oregon Energy Efficiency Specialty Code, Exterior Lighting, as modified by Section 4.199.40(.01) (B)(2).*

- E. Lighting plans shall be coordinated with landscaping plans so that pole lights and trees are not placed in conflict with one another. The location of lights shall be shown on the landscape plan. Generally, pole lights should not be placed within one pole length of landscape and parking lot trees.*
- F. Applicants shall identify the hours of the lighting curfew.*

(.02) – In addition to the above submittal requirements, applicants using the prescriptive method shall submit the following information as part of the permit set plan review.

- A. A site lighting plan (items A-F above) which indicates for each luminaire the 3 mounting height line to demonstrate compliance with the setback requirements. For luminaires mounted within 3 mounting heights of the property line the compliance exception or special shielding requirements shall be clearly indicated.*

- The proposed project meets the exemptions requirements of 4.199.40(.01)4. a, mounting height line is not required.**

- The proposed project will utilize the prescriptive method for outdoor lighting requirements. The Lighting Plan is included in the application package, indicating compliance with this section of the development code. The manufacturer’s product information is also included in the application package.**

Section 4.320 – Requirements

(.01) The developer or subdivider shall be responsible for and make all necessary arrangements with the serving utility to provide the underground services (including cost of rearranging any existing overhead facilities.) All such underground facilities as described shall be constructed in compliance with the rules and regulations of the Public Utility Commission of the State of Oregon relating to the installation and safety of underground lines, plant, system, equipment and apparatus.

(.03) Interior easements (back lot lines) will only be used for storm or sanitary sewers, and front easements will be used for other utilities unless different locations are approved by the City Engineer. Easements satisfactory to the serving utilities shall be provided by the developer and shall be set forth on the plat.

Section 4.400 Site Design Review

Section 4.421 Criteria and Application of Design Standards

(.01) The following standards shall be utilized by the Board in reviewing the plans, drawings, sketches and other documents required for Site Design Review. These standards are intended to provide a frame of reference for the applicant in the development of site and building plans as well as a method of review for the Board. These standards shall not be regarded as inflexible requirements. They are not intended to discourage creativity, inventions an innovation. The specifications of one or more particular architectural styles are not included in these standards.

- A. Preservation of Landscape. The landscape shall be preserved in its natural state, insofar as practicable, by minimizing tree and soil removal, and any grade changes shall be in keeping with the general appearance of the neighboring developed areas.*

- **The proposed site is currently vacant, *but has been previously cleared for development.* Any grading changes will be minimal. The proposed project will be generally (commercial) keeping the same appearance with the neighboring (restaurants) properties.**

B. Relation of Proposed Buildings to Environment. Proposed structures shall be located and designed to assure harmony with the natural environment, including protection of steep slopes, vegetation and other naturally sensitive areas or wildlife habitat and shall provide proper buffering from less intensive uses in accordance with Sections 4.171 and 4.139 and 4.139.5.

- **The proposed project site lies adjacent to highway I-5. The site is currently vacant. There are no steep slopes on the property nor any wildlife habitats.**

C. Drives, Parking and Circulation. With respect to vehicular and pedestrian circulation, including walkways, interior drives and parking, special attention shall be given to location and the number of access points, general interior circulation, separation of pedestrian and vehicular traffic, and arrangement of parking area that are safe and convenient and, insofar as practicable, do not detract from the design of proposed buildings and structures and the neighboring properties.

- **The proposed project will utilize the existing driveway on the adjacent lot. The project will extend the existing *public* sidewalk to the end of the project site. *As much as possible pedestrian and vehicular traffic have been separated, and where necessary, pedestrian crossings have been defined to provide safe and convenient pedestrian circulation.* The general vehicular circulation on the site has been modified to be one way around the gas pumps, and to the drive thru window.**

D. Surface Water Drainage. Special attention shall be given to proper site surface drainage so that removal of surface waters will not adversely affect neighboring properties of the public storm drainage system.

- **The proposed storm drainage plan will meet the requirements of Oregon Department of Environmental Quality, for construction and normal operating stormwater requirements.**

E. Utility Service. Any utility installations above ground shall be located so as to have a harmonious relation to neighboring properties and site. The proposed method of sanitary and storm sewage disposal from all buildings shall be indicated.

F. Advertising Features. In addition to the requirements of the City's sign regulations, the following criteria should be included: the size, location, design, color, texture, lighting and materials of all exterior signs and outdoor advertising structures or features shall not detract from the design of proposed buildings and structures and the surrounding properties.

- **Sign information is included in this application. Additional information will be under Section 4.156.01 Sign Regulations Purpose and Objectives**

(.04) Conditional application. The Planning Director, Planning Commission, Development Review Board or City Council may, as a Condition of Approval for a zone change, subdivision, land partition, variance, conditional use, or other land use action, require conformance to the site development standards set forth in this Section.

- **The proposed project will not require a Conditional Use Permit, the property follows the Comprehensive Plan which allows service centers at the project location.**

Section 4.430 Location, Design and Access Standards for Mixed Solid Waste and Recycling Areas

(.01) The following locations, design and access standards for mixed solid waste and recycling storage areas shall be applicable to the requirements of Section 4.179 of the Wilsonville City Code.

- **See comments under Section 4.179 Mixed Solid Waste and Recycling section.**

Section 4.440 Procedure

(.01) Submission of Documents. A prospective applicant for a building or other permit who is subject to site design review shall submit to the Planning Department, in addition to requirements of Section 4.035, the following:

- A. A site plan, drawn to scale, showing the proposed layout of all structures and other improvements...*
- B. A Landscape Plan, drawn to scale, showing the location and design of landscaped areas, the variety and sizes of trees and plant materials to be planted on the site, the location and design of landscaped areas...*
- C. Architectural drawings or sketches, drawn to scale, including floor plans, in sufficient detail to permit computation of yard requirements and showing all elevations of the proposed structures and other improvements...*
- D. A Color Board displaying specifications as to type, color, and texture of exterior surfaces of proposed structures.*
- E. A Sign Plan, drawn to scale, showing the location, size, design, material, color and methods of illumination of all exterior signs.*
- F. The required application fees.*

- **The above drawings are included in the application package.**

Section 4.600 Tree Preservation and Protection

Section 4.600.30 Tree Removal Permit Required

- **The proposed project will remove the 2 existing trees at the northwest corner of the property to provide adequate room for the new sidewalk; a Type C tree removal plan is provided with the Removal Application.**

Section 4.620.10 Tree Protection During Construction

(.01) Where tree protection is required by a condition of development under Chapter 4 or by the Tree Maintenance and Protection Plan approved under this subchapter, the following conditions apply:

- ***Tree protection for the remaining existing tree on the adjacent site has been provided for on the Landscape Plan.***



Planning Division
Development Permit Application

Final action on development application or zone change is required within 120 days in accordance with provisions of ORS 227.175

A pre application conference is normally required prior to submittal of an application. Please visit the City's website for submittal requirements

Pre-Application Meeting Date: December 17, 2020

Incomplete applications will not be scheduled for public hearing until all of the required materials are submitted.

29799 SW Town Center Loop E, Wilsonville, OR 97070
Phone: 503.682.4960 Fax: 503.682.7025
Web: www.ci.wilsonville.or.us

Applicant:

Name: Mark McKechnie
Company: Oregon Architecture Inc.
Mailing Address: 132 Main Street, Suite 101
City, State, Zip: Medford, OR 97501
Phone: (541) 772-4372 Fax:
E-mail: charles@oregonarchitecture.biz

Authorized Representative:

Name: Mark McKechnie
Company: Oregon Architecture Inc.
Mailing Address: 132 Main Street, Suite 101
City, State, Zip: Medford, OR 97501
Phone: (541) 772-4372 Fax:
E-mail: charles@oregonarchitecture.biz

Property Owner:

Name: Wilsonville Retail/Angel LLC
Company: Wilsonville Retail/Angel LLC
Mailing Address: 6454 N Greeley Ave
City, State, Zip: Portland, OR 97217
Phone: 503-525-9100 Fax:
E-mail: jangel@pacificstar.biz

Property Owner's Signature:

Printed Name: Peter Angel Date: 9/10/21
Applicant's Signature: (if different from Property Owner)
Printed Name: Date:

Site Location and Description:

Project Address if Available: 29760 SW Boones Ferry Rd., Wilsonville, OR 97070 Suite/Unit
Project Location: Vacant
Tax Map #(s): 31W14D Tax Lot #(s): 00900 County: Washington Clackamas

Request:

This request is for the approval of development, Site Design Review, sign permit and conditional use permit for a new, convenience store and 12 pump gas station located on Boones Ferry Rd.

Project Type: Class I Class II Class III

Residential Commercial Industrial Other:

Application Type(s):

- Annexation Appeal Comp Plan Map Amend Parks Plan Review
Final Plat Major Partition Minor Partition Request to Modify
Plan Amendment Planned Development Preliminary Plat Conditions
Request for Special Meeting Request for Time Extension Signs Site Design Review
SROZ/SRIR Review Staff Interpretation Stage I Master Plan Stage II Final Plan
Type C Tree Removal Plan Tree Permit (B or C) Temporary Use Variance
Villebois SAP Villebois PDP Villebois FDP Other (describe)
Zone Map Amendment Waiver(s) Conditional Use



June 3, 2022

Mark McKechnie
Oregon Architecture, Inc.
132 W. Main Street, Suite 101
Medford, OR 97501

Application Numbers: DB21-0045 through DB21-0048, WAIV22-0002, TPLN22-0004
Boones Ferry Gas Station/Store

Proposal: Stage I Preliminary Plan Modification, Stage II Final Plan, Site Design Review, Class 3 Sign Permit and Waiver, Type C Tree Removal Plan

Location/Legal: 29760 SW Boones Ferry Road, Wilsonville, OR 97070. Tax Lot 900, Section 14D, Township 3 South, Range 1 West, Willamette Meridian, Clackamas County, Oregon.

Status: Notice that Your APPLICATION IS COMPLETE

Dear Mr. McKechnie:

City of Wilsonville Site Development application forms submitted regarding the property described above list you as the applicant. The City initially received your applications on December 14, 2021, for a Stage I Preliminary Plan Amendment, Stage II Final Plan, Site Design Review, and Class 3 Sign Permit. You submitted additional information on March 22, 2022, in response to the city's incomplete letter dated January 12, 2022, and on May 23, 2022 in response to the City's incompleteness letter dated April 19, 2022.

Based on the information submitted, City staff has determined your application to be complete. The date of the determination is today, June 3, 2022. The application can now move forward to presentation and hearing before the Development Review Board (DRB).

For the purpose of applying the 120-day time limit, the application was deemed to be complete today, June 3, 2022. City staff will process the application based upon the material currently on file.

Please note our request that the comments and corrections included in the attached list related to compliance, which came to City staff's attention during the completeness review, be addressed

and/or incorporated as appropriate in the final set of application materials. Please provide 5 copies of the final set of plans (reduced 11" by 17", full sheet drawn to scale and **folded**, and electronic) and other materials (both paper and electronic copies), upon receipt of this notice and once requested corrections have been made, for publication and distribution to the DRB.

If you have any questions or require additional information, please contact me at 503-570-1583 or rybold@ci.wilsonville.or.us.

Sincerely,

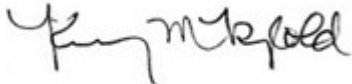
A handwritten signature in black ink, appearing to read "Kimber Rybold". The signature is written in a cursive style with a large initial "K".

Kimber Rybold, AICP
Senior Planner
City of Wilsonville

DB21-0045 through DB21-0048, WAIV22-0002, TPLN22-0004 Boones Ferry Gas Station/Store

Comments and corrections to be addressed in final application materials:

Planning Comments

- A. Show elevation and dimensions of gas pump canopy and identify locations of proposed canopy signage. Sheet CS1 is illegible.
- *SEE REVISED SHEET CS1 WITH FUEL CANOPY ELEVATIONS, DIMENSIONS AND SIGNAGE LOCATIONS.*
- B. Show drawing of pylon sign that complies with 20-foot height limit and 64-square-foot sign area limit. Panels for fuel prices are excluded from the 64-square-foot limit.
- *SEE REVISED SHEET S3.*
- C. Resubmit materials with consistent number for building square footage. Page 1 heading of revised narrative says 3,100 square feet, other references are to 2,999 square feet.
- *RESPONSE: PAGE 1 HEADING REVISED TO 2,999 SF.*
- D. Building signage is not allowed on the east and north facades of the building per Subsection 4.156.08 (.02) A. Building signage may be allowed on the east building façade in lieu of the proposed freestanding sign adjacent to I-5 as provided for in Subsection 4.156.08 (.02) B. 5. Revise drawings to show compliance.
- *RESPONSE: BUILDING SIGNAGE REMOVED FROM THE EAST AND NORTH FACADES OF THE BUILDING.*
- E. Provide dimensions for fuel price panels on the monument and pylon signs.
- *SEE REVISED SHEETS S1 AND S3.*
- F. Provide a Word version of the narrative/findings.
- *RESPONSE: WORD VERSION PROVIDED.*

Engineering Comments

- G. Revise plan set to illustrate driveway approach modifications as submitted by the project's Civil Engineer to the City's Development Engineering Manager.
- *SEE REVISED CIVIL PLANS THAT SHOW MODIFICATIONS TO THE APPROACH, C1-C3.*

Owner
Architect
Engineer
Consultant
Contractor
Other

Date
Job Name

May 19, 2022
Wilsonville Convenience Store
29760 SW Boones Ferry Road
Wilsonville, OR 97070
DB21-0045 – DB21-0048

Kimberly Rybold, AICP
Senior Planner
City of Wilsonville
Planning Department
(503) 570-1583
rybold@ci.wilsonville.or.us

Attached is the response to the city incompleteness letter.

If any additional information is needed I am hopeful we can handle it either over the phone or via email. I can be reached via telephone at the above number, or via e-mail at mark@oregonarchitectue.biz.

Thank you.



SIGNED: _____
(MARK MCKECHNIE, AIA)



April 19, 2022

Mark McKechnie
Oregon Architecture, Inc.
132 W. Main Street, Suite 101
Medford, OR 97501

Application Number: DB21-0045 through DB21-0048

Proposal: Stage I Preliminary Plan Modification, Stage II Final Plan, Site Design Review, Class 3 Sign Permit

Location: 29760 SW Boones Ferry Road, Wilsonville, OR 97070

Legal Description: Tax Lot 900, Section 14D, Township 3 South, Range 1 West, Willamette Meridian, Washington County, Oregon

Status: Notice that Your APPLICATION IS NOT COMPLETE

Mark McKechnie:

City of Wilsonville Site Development application forms submitted regarding the property described above list you as the applicant. The City initially received your applications on December 14, 2021, for a Stage I Preliminary Plan Amendment, Stage II Final Plan, Site Design Review, and Class 3 Sign Permit. You submitted additional information on March 22, 2022, in response to the city's incomplete letter dated January 12, 2022.

The application as submitted is still incomplete, based on the applicable provisions of ORS 227.178 (2) and Subsection 4.035(.05) Wilsonville Code ("WC"), due to the following missing items:

1. Incomplete written responses to applicable review criteria. As discussed in pre-application meeting comments, the city requires a project narrative with written findings explaining how all applicable criteria and standards are met by the proposal. The applicable review criteria include the following:

- On-Site Pedestrian Access and Circulation: Section 4.154 – The connection from the public sidewalk to building entrance crosses vehicles going into and out of the drive through loop. The revised narrative does not offer additional explanation about how this path is “safe, direct and convenient.” Provide details about the how pedestrian connections throughout the site meet this standard, due to location, paving treatment, or vertical or horizontal separation.
 - *The attached revised narrative addresses this criteria.*
 - *The circulation path of the parking lot and gas station have been revised to allow for improved pedestrian connections on the site. See the Schematic Site Plan on A0.1.*

- Parking, Loading, and Bicycle Parking: Section 4.155 – The revised finding states that the project “will request a waiver” for including the parking on the adjacent lot, but no additional information or waiver is included with the submitted materials. A shared parking agreement with adjacent owner may be used to satisfy minimum requirement, but this requires “satisfactory legal evidence” of a shared parking agreement for the specific number of spaces. A shared parking agreement must be accompanied by an analysis that there is sufficient parking to support the adjacent use, minus the shared spaces, or that the hours of peak parking demand do not overlap. Finally, if the 12 spaces at the gas pumps will be used to satisfy the minimum parking requirement (which staff has previously indicated to the applicant is allowed), this potentially eliminates the need for the shared parking, and the count on Sheet A0.1 should be updated.
 - *The 12 spaces at the gas pumps will be included in the parking count total and the count has been updated on sheet A0.1.*

- Signs: Sections 4.156.01 through 4.156.11 – Revised submittals have withdrawn some sign information and indicate a sign permit will be requested “later on” despite the inclusion of a Class III sign permit request. As previously communicated to the applicant, since this is new construction, Class III Sign Permit applications are typically included with the land use package as, per Section 4.031 of the Development Code, the review of sign location and size is under the jurisdiction of the Development Review Board for new construction. It is important to understand the location and size of any building and freestanding signs as they relate to the architecture and site plan for the project. Once approved by the DRB, the applicant would only need to obtain a Class I Sign Permit (staff level review) with the final sign designs.

If you elect not to complete the Class III sign permit with this application package, you would then need to go through a second Development Review Board public hearing process for approval of the project’s signs. Any required modifications to the building design or site plan to accommodate the signs could require additional

land use review. Given this, it is highly advisable to complete the Class III Sign Permit at this point. The site plan indicates locations for a monument sign and a pole sign. Written findings determining compliance with Sections 4.156.01 through 4.156.11 are necessary in order for staff and the DRB to determine whether they comply with code, and how they are integrated with the other site elements requested in the proposal. Identification of the location and size of building signs should also be included.

- *See sheets S7 – S9 for canopy fascia signage details.*
 - *See sheets S3 – S6 for free standing sign details.*
 - *See sheets S1 and S2 for monument sign details.*
 - *See updated elevations on sheets A2.0 and A2.1 with proposed building signage and the allowed area based on the façade length.*
- Tree Preservation and Protection: Sections 4.600 through 4.640.20 – The revised materials indicate two trees at the northwest corner of the property will be removed. They also indicate a future request for a Type C tree removal permit. The materials still do not address the status of a 14 inch maple that is on the east side of the driveway entrance to the property. Clarify if this tree will also be removed and address standards for tree removal for these frontage trees shown on survey drawing.
 - *This tree is to remain, see updated landscape plan on sheet L1.1.*
2. Insufficient detail in submitted plans and drawings. While some information is provided, the following specific information is missing:
- Landscape Plan
 - No tree protection or removal plan for Boones Ferry frontage trees east of driveway opening
 - *This tree is to remain, see updated landscape plan on sheet L1.1.*
 - General Site Plan
 - Gas pump parking space dimensions, if being used to meet minimum requirements
 - *The 12 spaces at the gas pumps will be included in the parking count total. The dimensions and the count have been updated on sheet A0.1.*
 - Location of propane storage tank shown on Sheet CS3
 - *See sheet CS4*
 - Architectural drawings
 - Revised elevations showing sign locations and designs
 - *See sheets S7 – S9 for canopy fascia signage details.*
 - *See sheets S3 – S6 for free standing sign details.*
 - *See sheets S1 and S2 for monument sign details.*
 - *See updated elevations on sheets A2.0 and A2.1 with proposed building signage and the allowed area based on the façade length.*

- Schematic Truck Turning Plan
 - The truck turning plan should be prepared by a registered engineer and shown on the surveyed site plan. The plan should include all of the site improvements on the RAM property, including parking spaces and landscaping islands, on this schematic.
 - *See preliminary truck turning plan on sheet C3.*
3. Insufficient information in the submitted Transportation Impact Study (TIS) to support the proposed use of the drive-thru. During scoping for the TIS, the applicant indicated that this window would be used for the sale of items within the convenience store. Given this, analysis under the Super Convenience Market/Gas Station ITE Code (960) was determined to be most appropriate for the use, serving as the basis for anticipated Transportation System Development Charges (SDCs) to be collected at the time of construction. In the response to the first incompleteness letter, the applicant noted that the drive-thru will be used for a food buffet inside the convenience store. The use of the drive-thru in this manner requires additional transportation analysis to account for the portion of the space devoted to food service use. This will also have an impact on SDCs that will be required at the time of construction.
 - *The traffic for the proposed drive-thru has been addressed, please see the revised narrative.*
 4. Correspondence from TVF&R indicating feasibility of providing services. The revised narrative cites a TVF&R permit number but does not include a copy of the service provider permit.
 - *See attached copy of the approved application and plans.*
 5. Sign Plan including:
 - Drawings or descriptions of all materials, sign area and dimensions used to calculate areas, lighting methods, and other details sufficient to judge the full scale of the signs and related improvements.
 - *See sheets S7 – S9 for canopy fascia signage details.*
 - *See sheets S3 – S6 for free standing sign details.*
 - *See sheets S1 and S2 for monument sign details.*
 - *See updated elevations on sheets A2.0 and A2.1 with proposed building signage and the allowed area based on the façade length*
 - Sign features on canopy, if proposed.
 - *See sheets S7 – S9 for canopy fascia signage details.*
 - Dimensions of pole sign.
 - *See sheets S3 – S6 for free standing sign details.*
 - Day and night versions of pole sign.
 - *See sheets S3 – S6 for free standing sign details.*
 - Details for monument sign, like connection to ground.
 - *See sheets S1 and S2 for monument sign details.*
 - Waiver for electronic changeable copy sign, if proposed.

- Completed by the City of Wilsonville; WAIV22-0002.
 - Drawings of all building facades on which signs are proposed, indicating the areas of the facades on which signs will be allowed.
 - See updated elevations on sheets A2.0 and A2.1 with proposed building signage and the allowed area based on the façade length.
6. The Stormwater Report refers to a Geotech Report that identifies 4-5" of infiltration at this site. The applicant should provide the Geotech Report with the application to confirm this.
- Geotech report provided.
7. The easement document provided shows the access, but does not address the proposed storm facility straddling the property line and the allowance for the connection to the private storm lateral. Provide a copy of a draft easement showing how these facilities will be addressed.
- See sheets C1 & C2 along with the preliminary drainage report.
 - See the provided draft easement, attached.

In addition to the incompleteness items listed above, the following questions and comments regarding compliance came to City staff's attention while reviewing the materials for completeness. This list is not intended to be a comprehensive review of potential compliance issues, which will occur upon receipt of a completed application. Please respond and/or incorporate into updated materials as appropriate.

Engineering Comments (in addition to incomplete items included above)

- A. It appears that the drainage from the parking area is proposed to be directed toward the fueling island. That drainage must be hydraulically separated from the fueling island.
- Noted, see sheets C1 & C2 along with the preliminary drainage report.
- B. An underground injection control facility at a gas station is not authorized by rule by DEQ and must be permitted. As the site has a connection to the public system, it is likely that this process will take some time to actually get permitted. Because development on this site is dependent on getting this permitted, better documentation that this can be approved by DEQ should be submitted.
- Noted, see sheets C1 & C2 along with the preliminary drainage report.
- C. The westernmost access point for the site does not meet minimum clear drive aisle requirements as noted in the 2017 Public Works Construction Standards. This minimum may be reduced to 20 feet from the back of sidewalk pursuant to the criteria identified in subsection 201.2.23.m. These criteria require on-site circulation to be designed in a way to not create a safety hazard by reducing the clear drive aisle length.

The current drive-thru configuration requires customers entering the drive-thru lane to cross over the path of customers leaving the drive-thru and others circulating throughout the site which may create conflicts and disrupt circulation on the site.

- *The westernmost site access point is existing and has a length of 21'-1", see the site plan on sheet A0.1.*
- *The circulation path of the parking lot and gas station have been revised to allow for improved pedestrian connections on the site. With the site circulation changed to have the east opening be the ingress location, and the west open be the egress location, we have eliminated the potential conflict of patrons wanting to immediately turn left into the project after clearing Boones Ferry Road and the potential hazards of cross traffic at the west site opening. See the Schematic Site Plan on A0.1 for the site traffic pattern diagram.*

Incompleteness items 1-7 need to be addressed in order to complete the applications. Please provide 3 copies of the revised project narrative, findings, and reduced 11" by 17" plans, full sheet plans drawn to scale and folded plus an electronic copy of the project narrative, findings, and plans. When you have resubmitted the application materials, staff will have up to 30 days to determine whether the application is complete. ORS 227.178. Upon determination the application is complete please provide 7 additional copies of the materials listed above. If there are revisions please provide 10 copies of the final set of plans and other materials, both paper and electronic copies.

If you have any questions or require additional information, please contact me at 503-570-1583 or rybold@ci.wilsonville.or.us.

Sincerely,

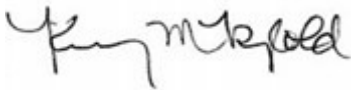

Kimberly Rybold, AICP

Owner
Architect
Engineer
Consultant
Contractor
Other

Date
Job Name

March 22, 2022
Wilsonville Convenience Store
29760 SW Boones Ferry Road
Wilsonville, OR 97070
DB21-0045 – DB21-0048

Kimberly Rybold, AICP
Senior Planner
City of Wilsonville
Planning Department
(503) 570-1583
rybold@ci.wilsonville.or.us

Attached is the response to the city incompleteness letter.

If any additional information is needed I am hopeful we can handle it either over the phone or via email. I can be reached via telephone at the above number, or via e-mail at mark@oregonarchitectue.biz.

Thank you.



SIGNED: _____
(MARK MCKECHNIE, AIA)



January 12, 2022

Mark McKechnie
Oregon Architecture, Inc.
132 W. Main Street, Suite 101
Medford, OR 97501

Application Number: DB21-0045 through DB21-0048

Proposal: Stage I Preliminary Plan Modification, Stage II Final Plan, Site Design Review, Class 3 Sign Permit

Location: 29760 SW Boones Ferry Road, Wilsonville, OR 97070

Legal Description: Tax Lot 900, Section 14D, Township 3 South, Range 1 West, Willamette Meridian, Clackamas County, Oregon

Status: Notice that Your APPLICATION IS NOT COMPLETE

Mark McKechnie:

City of Wilsonville Site Development application forms submitted regarding the property described above list you as the applicant. The City initially received your applications on December 14, 2021, for a Stage I Preliminary Plan Amendment, Stage II Final Plan, Site Design Review, and Class 3 Sign Permit.

The application submitted is incomplete, based on the applicable provisions of ORS 227.178 (2) and Subsection 4.035(.05) Wilsonville Code ("WC"), due to the following missing items:

1. Incomplete written responses to applicable review criteria. As discussed in pre-application meeting comments, the city requires a project narrative with written findings explaining how all applicable criteria and standards are met by the proposal. The applicable review criteria include the following:

Commercial Development Standards

- Planned Development Commercial (PDC) Zones and Commercial Standards: Section 4.116 and 4.131

General Development Regulations and Standards

- On-Site Pedestrian Access and Circulation: Section 4.154: Explain how connection from public sidewalk to building entrance is “safe, direct and convenient” and provide details about pedestrian connection paving treatment, vertical or horizontal separation.
- Parking, Loading, and Bicycle Parking: Section 4.155: Provide shared parking agreement with adjacent owner used to satisfy minimum requirement. Quantify parking at gas pumps if using to meet standard. Use accurate square footage in parking calculations.
- Street Improvement Standards: Section 4.177: Explain how entry meets clear vision area standard, considering landscaping and proposed monument sign.
- Landscaping, Screening, and Buffering: Section 4.176: Explain, in narrative form, how each standard is met.
- Outdoor Lighting: Sections 4.199 through 4.199.60: Provide details about how lighting standards are met under prescriptive method. Include information about lighting under proposed canopy.
- Underground Utilities: Sections 4.300 through 4.320: Explain how utilities connect to the site. No utility plan provided.
 - *The attached narrative addresses this criteria.*

Signs

- Signs: Sections 4.156.01 through 4.156.11: Provide findings for how sign code is met. Sign permit information submitted December 27 does not have applicant findings. A DRB sign waiver to allow an electronic changeable copy sign (to list fuel prices) is required per Section 4.156.02(.08). **Written findings and the associated waiver request application fee (\$592) are necessary concurrent with the Class III sign permit request.**
 - *The sign permit is to be a separate submittal later on.*

Trees

- Tree Preservation and Protection: Sections 4.600 through 4.640.20: Address standards for tree removal for the Boones Ferry frontage trees shown on survey drawing. **Since there is tree removal proposed with development, a Type C Tree Removal Plan meeting the requirements of Subsection 4.610.40 and associated application fee (\$167) are required as part of the application package.**
 - *The 2 existing maple trees on the frontage of Boones Ferry Road that are next to the new proposed sidewalk and drive-thru will need to be removed due to their proximity to the new sidewalk. A Type C Tree application and fee will be submitted.*

2. Insufficient detail in submitted plans and drawings. While some information is provided, the following specific information is missing or internally inconsistent:

- Cover Sheet
 - Building size in project description inconsistent with other sheets

- *Building size updated to match other sheets, 3,000 SF.*
- Landscape Plan
 - No tree protection or removal plan for Boones Ferry frontage trees shown on survey
 - *There is now a landscape plan provided with this information; see L.1.*
 - Sign locations or landscaping around them
 - *There is now a landscape plan provided with this information; see L.1.*
 - *There are also sign locations shown on the Schematic Site Plan; see A0.1.*
 - Vision clearance areas at entry
 - *There is now a landscape plan provided with this information; see L.1.*
- General Site Plan
 - Correct location of signs
 - *There are sign locations shown on the Schematic Site Plan; see A0.1.*
 - Additional detail on sidewalk improvements
 - *Sidewalk & right-of-way improvements shown on the Schematic Site Plan; see A0.1*
 - Gas pump parking space locations and dimensions
 - *Gas pump parking locations and dimensions shown on the Schematic Site Plan; see A0.1*
 - Parking lot landscape island/trees on adjacent property (due to proposed circulation plan)
 - *Adjacent property parking lot landscape island/trees shown on the Schematic Site Plan; see A0.1*
- Grading Plan
 - Proposed contours
 - *See Topographic Survey on 1/1 and civil sheets C1 and C2.*
 - Need full utility plan showing water, sewer, storm sewer connections details
 - *See Preliminary Utility Plan on C2.*
 - Bioswale details
 - *See Preliminary Grading Plan on C1, Preliminary Utility Plan on C2, and Preliminary Drainage Report.*
- Truck Turn Radius Plan
 - Parking lot landscape island/trees on adjacent property (due to proposed truck circulation).
 - *Existing parking lot landscape island/trees shown on adjacent property on the Schematic Truck Turning Radius plan; see A0.5.*
- Outdoor Lighting Plan
 - Existing pole at south corner of property to remain?
 - *The existing light pole at the south corner of the property to remain, this is shown on the Schematic Site Plan; see A0.1.*
 - Illustrate any lighting proposed on the fuel canopy

- *Proposed canopy lighting shown on CS2.*
 - Indicate location of proposed wall wash lighting on building elevations
 - *See Schematic Site Lighting Plan, A0.6.*
 - Architectural drawings. Current elevations do not show adequate level of detail for building materials, features, color, etc. In addition to the submitted elevations and material information, provide the following:
 - North elevation of building
 - *North elevation shown on A2.1.*
 - Fueling canopy elevation drawings with dimensions
 - *Fueling canopy elevations shown on CS1.*
 - Color board displaying specifications as to type, color, and texture of the exterior surfaces of the proposed structures
 - *See Exterior Color Board on sheet A2.2.*
 - Details on outdoor furnishings (bike rack, garbage cans, lighting, benches, etc.)
 - *See site details on A0.2.*
 - East elevation indicates exterior doors not shown on other plans
 - *East elevation revised to show exterior door; see A2.0.*
 - Revised elevations showing sign locations and designs.
 - *The sign permit is to be a separate submittal later on.*
3. Service Provider Permit from TVF&R indicating feasibility of providing services. Please visit the TVF&R's online portal to obtain this permit: <https://www.tvfr.com/399/Service-Provider-Permit>. Show fire hydrant locations and servicing water lines on plans.
- *Service Provider Permit submitted on 2/14/22. TVFR permit # 2022-0021 approved on 02-23-22. Fire hydrants and water lines shown on the Topographic Survey on sheet 1/1.*
4. Information about drive-through window operations: services provided, volumes, and intensity. This information will help determine anticipated length of queues and potential for disrupting public sidewalk or right of way.
- *The drive-thru will be used for a small Indian food buffet that is located inside the Family Mart. This is not a chain restaurant and will only have a small kitchen so the anticipated volumes are not very large.*
5. Sign Plan revisions including:
- Drawings or descriptions of all materials, sign area and dimensions used to calculate areas, lighting methods, and other details sufficient to judge the full scale of the signs and related improvements.
 - Sign features on canopy, if proposed.
 - Dimensions of pole sign that match overall height.
 - Day and night versions of pole sign that match.
 - Details for monument sign, like connection to ground.
 - Waiver for electronic changeable copy sign.

- Drawings of all building facades on which signs are proposed, indicating the areas of the facades on which signs will be allowed.
 - *The sign permit is to be a separate submittal later on.*
- 6. Information in narrative and updated plans should confirm compliance with Transportation Systems Plan and utility systems and master plans.
 - *See attached provided narrative.*
- 7. Preliminary stormwater report to determine adequacy of proposed bioswale. It is noted that the proposed stormwater facility encroaches on the adjacent property, which is inconsistent with the City's Public Works Construction Standards that require construction of stormwater management facilities to be located onsite.
 - *See provided Preliminary Drainage Report.*

In addition to the incompleteness items listed above, the following questions and comments regarding compliance came to City staff's attention while reviewing the materials for completeness. This list is not intended to be a comprehensive review of potential compliance issues, which will occur upon receipt of a completed application. Please respond and/or incorporate into updated materials as appropriate.

- A. According to the provided survey, the building north of the site encroaches 1.1 feet into the subject property. Because there is a zero setback requirement, this is not a zoning issue, but it could be addressed (with a property line adjustment) as part of this land use application.
 - *The owner is aware of this and is dealing with it with his attorney.*
- B. Ensure items shown on the site plan and elevations match. (e.g., sign locations)
 - *Yes, see site plan on A0.1 and elevations on A2.0 & A2.1.*
- C. Sign face area for pole sign as shown (daytime version) exceeds area limit.
 - *The sign permit is to be a separate submittal later on.*
- D. Parking count in summary table does not match quantity shown on plans.
 - *See revised parking count and site plan on A0.1.*

Engineering Comments (in addition to incomplete items included above)

- A. Provide utility plan showing utility connection locations.
 - *See Preliminary Utility Plan on C2.*
- B. Show dedication for Boones Ferry Road. New right-of-way line shall be 11.5 feet from face of curb. Dedications ranges from 8.85 to 9.25 feet based upon survey data.
 - *See right-of-way proposed on Schematic Site Plan A0.1.*
- C. Show 8-foot Public Utility Easement (PUE) along Boones Ferry Road right-of-way frontage.
 - *See 8' PUE shown on the Boones Ferry Rd side; see Schematic Site Plan on A0.1.*
- D. Curb tight sidewalk not allowed. Provide 6 foot wide planter strip and 5 foot wide

sidewalk.

- *New sidewalk & right-of-way shown on Schematic Site Plan; see A0.1.*
- E. Provide proof of access easement from southern property.
- *Reciprocal Easement & License Agreement provided see attached documentation,*
- F. Truck turn schematic appears to encroach on existing parking spaces on the southern property. Revise site plan to avoid conflicts.
- *Truck turning revised to avoid parking conflicts on southern property; see A0.5.*
- G. Show clear vision area on site plan for the driveway approach.
- *See Schematic Site Plan on A0.1.*
- H. Submit Stormwater Report.
- *See provided Preliminary Drainage Report.*
- I. All existing utilities shall be placed underground along Boones Ferry Road. The utility plan shall show this.
- *See Preliminary Utility Plan on C2.*

Incompleteness items 1-7 need to be addressed in order to complete the applications. Please provide 3 copies of the revised project narrative, findings, and reduced 11" by 17" plans, full sheet plans drawn to scale and folded plus an electronic copy of the project narrative, findings, and plans. When you have resubmitted the application materials, staff will have up to 30 days to determine whether the application is complete. ORS 227.178. Upon determination the application is complete please provide 7 additional copies of the materials listed above. If there are revisions please provide 10 copies of the final set of plans and other materials, both paper and electronic copies.

If you have any questions or require additional information, please contact me at 503-570-1583 or rybold@ci.wilsonville.or.us.

Sincerely,

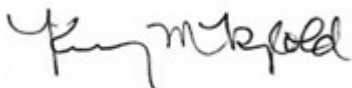

Kimberly Rybold, AICP

WILSONVILLE PACIFIC STAR GAS STATION TRANSPORTATION IMPACT STUDY

JUNE 2021

PREPARED FOR:



117 COMMERCIAL STREET NE, SUITE 310, SALEM, OR 97301 • 503.391.8773 • DKSASSOCIATES.COM

SHAPING A SMARTER TRANSPORTATION EXPERIENCE™

AN EMPLOYEE-OWNED COMPANY

PREPARED FOR CITY OF WILSONVILLE



PREPARED BY DKS ASSOCIATES

Scott Mansur, P.E., PTOE

Jenna Bogert, P.E.



TABLE OF CONTENTS

INTRODUCTION	1
EXISTING CONDITIONS	2
STUDY AREA ROADWAY NETWORK.....	2
EXISTING TRAFFIC VOLUMES.....	4
INTERSECTION PERFORMANCE MEASURES.....	5
EXISTING INTERSECTION OPERATIONS.....	6
PROJECT IMPACTS	7
PROPOSED DEVELOPMENT.....	7
FUTURE ANALYSIS SCENARIOS.....	7
TRIP GENERATION.....	7
VEHICLE TRIP DISTRIBUTION.....	8
FUTURE TRAFFIC VOLUMES.....	10
FUTURE INTERSECTION OPERATIONS.....	13
FUTURE QUEUING ANALYSIS.....	14
SITE REVIEW	15
SUMMARY OF PROJECT IMPACTS	17
APPENDIX	18

LIST OF FIGURES

FIGURE 1: STUDY AREA1

FIGURE 2: SMART BUS ROUTE 4 MAP3

FIGURE 3: 2021 EXISTING TRAFFIC VOLUMES, LANE GEOMETRIES, AND TRAFFIC CONTROL5

FIGURE 4: TRIP DISTRIBUTION AND PROJECT TRIPS9

FIGURE 5: EXISTING + STAGE II PM PEAK HOUR TRAFFIC VOLUMES..... 10

FIGURE 6: EXISTING + PROJECT PM PEAK HOUR TRAFFIC VOLUMES 11

FIGURE 7: EXISTING + STAGE II + PROJECT PM PEAK HOUR TRAFFIC VOLUMES 12

LIST OF TABLES

TABLE 1: STUDY AREA AND PROPOSED PROJECT CHARACTERISTICS2

TABLE 2: STUDY AREA ROADWAY CHARACTERISTICS3

TABLE 3: EXISTING 2021 INTERSECTION OPERATIONS6

TABLE 4: VEHICLE TRIP GENERATION8

TABLE 5: FUTURE INTERSECTION OPERATIONS 13

TABLE 6: FUTURE PM PEAK HOUR QUEUES 14

TABLE 7: VEHICLE AND BICYCLE PARKING REQUIREMENTS 16

INTRODUCTION

This study evaluates the transportation impacts associated with the proposed Pacific Star gas station and convenience market to be located on SW Boones Ferry Road in Wilsonville, Oregon. The location of the proposed development is currently a vacant parcel located just to the north of The RAM Restaurant and Brewhouse. The owner desires to build a 3,460 square-foot convenience market with a drive-through window and a 12-pump gas station.

The purpose of this transportation impact analysis is to identify potential mitigation measures needed to offset transportation impacts that the proposed development may have on the nearby transportation network. The impact analysis is focused on the study intersections, which were selected for evaluation in coordination with City staff. The intersections are listed below and shown in Figure 1 (next page).

1. SW Wilsonville Road/ SW Boones Ferry Road
2. SW Wilsonville Road/ I-5 Southbound Ramps
3. SW Wilsonville Road/ I-5 Northbound Ramps

Typically, the project site driveway(s) would be included in the list of study intersections and would be analyzed for peak hour vehicle operations and safety. However, the project driveway for the gas station on Boones Ferry Road is an existing access to the RAM Restaurant and Brewhouse and therefore, has already been approved by the City. Additionally, in order to evaluate vehicle operations, existing vehicle counts would need to be collected at the driveway, but due to COVID-19 restrictions, restaurants have been either been closed or open at limited seating capacity.

Therefore, collecting new driveway counts would not have been an accurate representation of typical traffic volumes for that location. Lastly, a typical improvement at project driveways to mitigate safety and improve operations is a left turn lane into the site. The existing driveway already has a two-way center turn lane present to facilitate two-stage left turns out of the site and allow left turning vehicles into the site to queue in a separate lane and not in the through travel lane, improving operations and safety. For these reasons, the existing driveway was not included in the list of study intersections for analysis.



FIGURE 1: STUDY AREA

Table 1 lists important characteristics of the study area and proposed project.

TABLE 1: STUDY AREA AND PROPOSED PROJECT CHARACTERISTICS

STUDY AREA	
NUMBER OF STUDY INTERSECTIONS	Three
ANALYSIS PERIODS	Weekday PM peak hour (highest hour between 4pm – 6pm)
PROPOSED DEVELOPMENT	
SIZE AND LAND USE	3,460 square-foot convenience market with a drive-through window and a 12-pump gas station
PROJECT TRIPS	240 total PM peak hour trips (120 in, 120 out)
VEHICLE ACCESS POINTS	Access to the site will be provided via an existing full-access driveway located on the RAM property directly to the south.
OTHER TRANSPORTATION FACILITIES	
PEDESTRIAN AND BICYCLE FACILITIES	Sidewalks and bicycle lanes currently exist along most of Boones Ferry Road. However, there are no sidewalks directly fronting the project site.
TRANSIT FACILITIES	Bus stop for SMART Transit Route 4 and 2X is located on Boones Ferry Road, approximately 130 feet south of the project site.

EXISTING CONDITIONS

This chapter provides documentation of existing study area conditions, including the study area roadway network, pedestrian and bicycle facilities, and existing traffic volumes and operations.

STUDY AREA ROADWAY NETWORK

Key roadways in the study area are summarized in Table 2 along with their existing roadway characteristics. Adjacent to the project site, Boones Ferry Road is identified as a Collector. The functional classifications for City of Wilsonville streets are provided in the City of Wilsonville Transportation System Plan (TSP).¹

¹ Wilsonville Transportation System Plan, Amended November 16, 2020.

TABLE 2: STUDY AREA ROADWAY CHARACTERISTICS

ROADWAY	FUNCTIONAL CLASSIFICATION	LANES	POSTED SPEED	SIDEWALKS	BIKE FACILITIES	ON-STREET PARKING
SW BOONES FERRY RD	Collector	3	35 mph	Partial ^a	Yes	No
SW WILSONVILLE RD	Major Arterial	4	25 mph	Yes	Yes	No
INTERSTATE 5	Urban Interstate	4	65 mph	No	No	No

^a No sidewalks present directly fronting the project site.

BICYCLE AND PEDESTRIAN FACILITIES

There are existing marked bicycle lanes on SW Boones Ferry Road beginning at SW Wilsonville Road and ending at the northern edge of the project site. Sidewalks currently exist on both sides of SW Boones Ferry Road between SW Wilsonville Road and the northern edge of the project site, except directly fronting the project site.

PUBLIC TRANSIT SERVICE

South Metro Area Regional Transit (SMART) provides public transportation services within Wilsonville and outlying areas, including Canby, Salem, and the south end of Portland. There are two bus stops along SW Boones Ferry Road near the project site for Route 4 and 2X, with one located as close as 130 feet south of the project site.

- Route 4 (Wilsonville Road) runs east-west between Graham Oaks Park and Meridian Creek Middle School via Wilsonville Road (see Figure 2 to the right). Service is provided Monday through Friday with headways of 75-90 minutes between the hours of 5 am – 9:30 am and 3 pm – 8 pm. This bus route frequency has been reduced during COVID-19.
- Route 2X (Tualatin Park & Ride) runs north-south between Wilsonville Transit Center and the Tualatin Park and Ride. Service is provided Monday through Friday with headways around 30 minutes between 5:45 am – 10:45 pm.

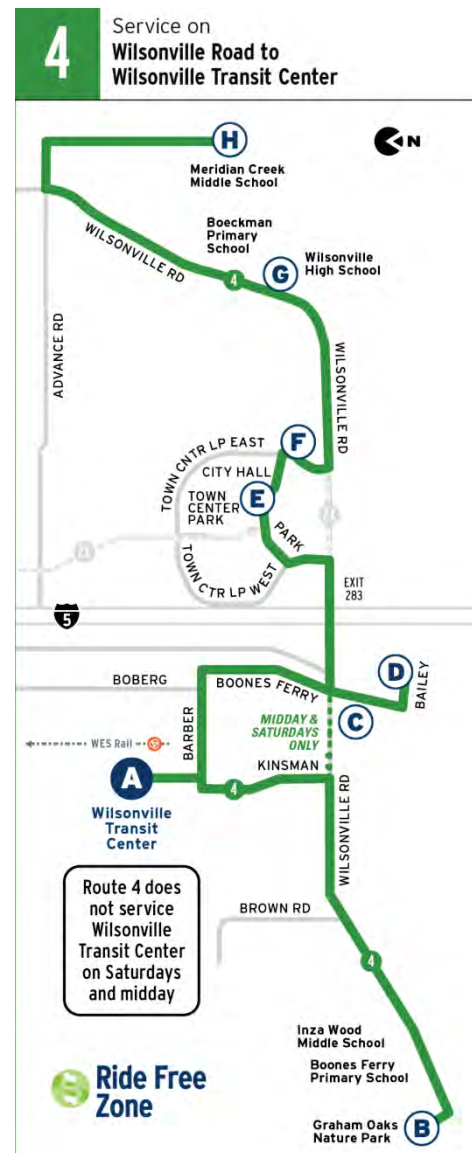

FIGURE 2: SMART BUS ROUTE 4 MAP

PLANNED PROJECTS

The City of Wilsonville Transportation System Plan (TSP) has a list of Higher Priority projects which includes the recommended projects reasonably expected to be funded through 2035. These are the highest priority solutions to meet the City's most important needs. The list includes the following projects that impact the key roadways near the proposed project site.²

- RW-03 - Widen eastbound SW Wilsonville Road east of SW Boones Ferry Road by removing the center median. This project involves lane configuration analysis to best address congestion.

EXISTING TRAFFIC VOLUMES

Historic turn movement count data was utilized for this traffic impact study. The historic data was collected during a weekday p.m. peak period (4:00-6:00 p.m.). The intersections were collected on these dates.

- SW Wilsonville Road at SW Boones Ferry Road: May 9, 2019
- SW Wilsonville Road at I-5 Southbound Ramps: November 3, 2016
- SW Wilsonville Road at I-5 Northbound Ramps: November 3, 2016

These historical counts were factored up to 2021 conditions by assuming a yearly growth rate of 2%. This yearly growth rate is a typical growth rate used in Wilsonville traffic impact studies and has been calculated using the Wilsonville Travel Demand model in previous studies.

Figure 1 shows the 2021 existing PM peak hour traffic volumes for the study intersections, along with the lane configurations and traffic control. The original two-hour traffic counts are included in the Appendix A.

² Table 5-3/Figure 5-4 and Table 5-4/Figure 5-5, Wilsonville Transportation System Plan, Amended April 15, 2019.

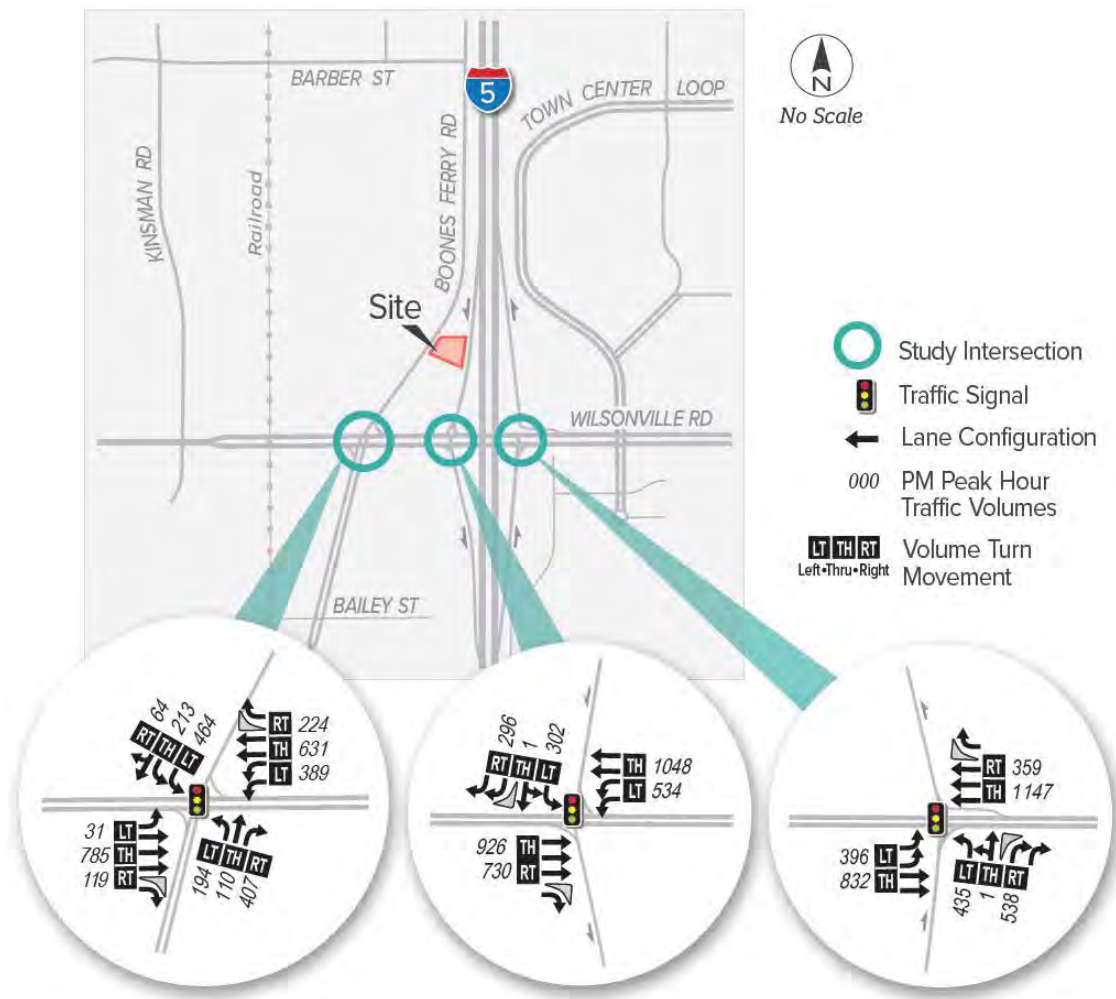

FIGURE 3: 2021 EXISTING TRAFFIC VOLUMES, LANE GEOMETRIES, AND TRAFFIC CONTROL

INTERSECTION PERFORMANCE MEASURES

Agency mobility standards often require intersections to meet level of service (LOS) or volume-to-capacity (v/c) intersection operation thresholds. Additional details about LOS and delay are provided in Appendix B.

- The intersection LOS is similar to a “report card” rating based upon average vehicle delay. Level of service A, B, and C indicate conditions where traffic moves without significant delays over periods of peak hour travel demand. Level of service D and E are progressively worse operating conditions. Level of service F represents conditions where average vehicle delay has become excessive and demand has exceeded capacity. This condition is typically evident in long queues and delays.
- The volume-to-capacity (v/c) ratio represents the level of saturation of the intersection or individual movement. It is determined by dividing the peak hour traffic volume by the maximum hourly capacity of an intersection or turn movement. When the V/C ratio

approaches 0.95, operations become unstable and small disruptions can cause the traffic flow to break down, resulting in the formation of excessive queues.

The City of Wilsonville requires study intersections on public streets to meet its minimum acceptable level of service (LOS) standard, which is LOS D for the overall intersection for the PM peak period.

For intersections under ODOT jurisdiction on Wilsonville Road, the mobility target is $v/c \leq 0.90$ when the interchange vicinity is fully developed and adequate storage is available on the interchange ramp to prevent queues from backing up on the mainline. Vehicle queues were analyzed in this report (see the [Future Queuing Analysis](#) section) and were determined not to extend onto the I-5 mainline.

EXISTING INTERSECTION OPERATIONS

An analysis of the 2021 existing intersection operations was performed at the three study intersections to determine the current operating conditions of the study area. Intersection operations were analyzed for the PM peak hour using Highway Capacity Manual (HCM) 6th Edition methodology.³ The volume to capacity (v/c) ratio, delay, and level of service (LOS) of each study intersection are listed in Table 3.

TABLE 3: EXISTING 2021 INTERSECTION OPERATIONS

INTERSECTION	OPERATING STANDARD/ MOBILITY TARGET	PM PEAK HOUR		
		V/C	DELAY	LOS
SIGNALIZED				
SW WILSONVILLE ROAD/SW BOONES FERRY ROAD	LOS D	0.76	43.4	D
SW WILSONVILLE ROAD/I-5 SOUTHBOUND RAMPS	$v/c \leq 0.90^a$	0.48	21.2	C
SW WILSONVILLE ROAD/I-5 NORTHBOUND RAMPS	$v/c \leq 0.90^a$	0.53	20.6	C

Signalized intersections:

Delay = Average Stopped Delay per Vehicle (sec)

LOS = Level of Service of Intersection

v/c = Volume-to-Capacity Ratio of Intersection

^a The mobility target for ODOT interchanges is 0.90 when the interchange vicinity is fully developed, and adequate storage is available on the interchange ramp to prevent queues from backing up on the mainline. Vehicle queues for this scenario were determined not to extend onto the I-5 mainline in this report.

As shown, all study intersections meet the operating standard (LOS D) and ODOT mobility target ($v/c \leq 0.90$) for the existing conditions. The HCM reports are provided in Appendix C.

³ Highway Capacity Manual, 6th Edition, Transportation Research Board, 2017.

PROJECT IMPACTS

This chapter reviews the impacts that the proposed development may have on the study area transportation system. This analysis includes site plan evaluation, trip generation, trip distribution, and future year traffic volumes and operating conditions for the four study intersections.

PROPOSED DEVELOPMENT

The owner desires to build a 3,460 square-foot convenience market with a drive-through window and a 12-pump gas station. The location of the proposed development is currently a vacant parcel located just to the north of the RAM Restaurant and Brewhouse.

FUTURE ANALYSIS SCENARIOS

Operating conditions were analyzed at the study intersections for the following traffic scenarios. The comparison of the following scenarios enables the assessment of project impacts:

- Existing + Stage II
- Existing + Project
- Existing + Stage II + Project

All future analysis scenarios assume the same traffic control as existing conditions. Stage II represents traffic from other developments that have Stage II approval or are under construction in Wilsonville.

TRIP GENERATION

Trip generation is the method used to estimate the number of vehicles added to site driveways and the adjacent roadway network by a development during a specified period (i.e., such as the PM peak hour). For this study, the Institute of Transportation Engineers (ITE) trip generation rates for Super Convenience Market/Gas Station (960) were used to estimate the site's trip generation.⁴

The trip generation for Land Use 960 is calculated based on either the number of fueling positions or the size of the convenience market. Because this convenience market has a drive-through window and is larger (3,460 square feet) than a typical convenience market (average size of 2,600 square feet for City of Wilsonville), the trip generation for this analysis is based on the gross floor area of the convenience market not the fueling positions. Additionally, a Fred Meyer gas station is located 0.4 miles to the west of the proposed Pacific Star gas station. The presence of both gas stations which will reduce the demand for either gas station.

The proposed gas station provides the opportunity for pass-by vehicle trips coming from and returning to the adjacent traffic stream (i.e., SW Wilsonville Road) that would not create new trips within the study area. To estimate pass-by trips, the methodology outlined in the current ITE Trip

⁴ Trip Generation Manual, 10th Edition, Institute of Transportation Engineers, 2017.

Generation Handbook was used.⁵ Pass-by trips for the gas station were estimated to divert from SW Wilsonville Road onto SW Boones Ferry Road. The pass-by trips result in new turning volumes at the SW Wilsonville Road/SW Boones Ferry Road intersection, but do not increase the total traffic on SW Wilsonville Road. There are no pass-by percentages provided in the ITE Handbook for Land Use 960, therefore, the average pass-by percentage for Land Use 945 in the p.m. peak hour was utilized instead for this development as it is a very similar land use.

The trip generation for the proposed development is shown in Table 4.

TABLE 4: VEHICLE TRIP GENERATION

LAND USE (ITE CODE)	SIZE ^a	PM PEAK TRIP RATE	PM PEAK TRIPS			DAILY TRIPS
			IN	OUT	TOTAL	
SUPER CONVENIENCE MARKET/GAS STATION (960)	3,460 KSF	69.3 trips per KSF	120	120	240	2,898
		<i>Pass-By Trip Reduction (56%)</i>	-67	-67	-134	-1,622
		TOTAL NET NEW TRIPS	53	53	106	1,276

^a KSF = 1,000 square feet

As shown, the proposed development is expected to generate a total 240 PM peak hour trips (120 in, 120 out) and a total 106 net new trips (53 in, 53 out). The project trips at the study intersections are shown in Figure 4 in the following section.

VEHICLE TRIP DISTRIBUTION

Vehicle trip distribution provides an estimation of where vehicles would be coming from and going to. It is given as a percentage at key gateways to the study area and is used to route project trips through the study intersections. Figure 4 shows the trip distribution for the proposed site. The trip distribution was based on the Wilsonville Travel Demand Model.⁶

PROJECT TRIPS THROUGH CITY OF WILSONVILLE INTERCHANGE AREAS

The project trips through the two City of Wilsonville I-5 interchange areas were estimated based on the trip generation and distribution assumptions. Approximately 50% of the project trips are expected to travel through the I-5/Wilsonville Road interchange area and less than 5% are expected to travel through the I-5/Elligsen Road interchange area; that is, the proposed development is expected to generate 53 net new PM peak hour trips through the I-5/Wilsonville Road interchange area and 5 net new PM peak hour trips through the I-5/Elligsen Road interchange area.

⁵ Trip Generation Handbook, 3rd Edition, Institute of Transportation Engineers, 2017.

⁶ Select zone analysis for zone 4010 in 2035 Wilsonville Travel Demand Model.

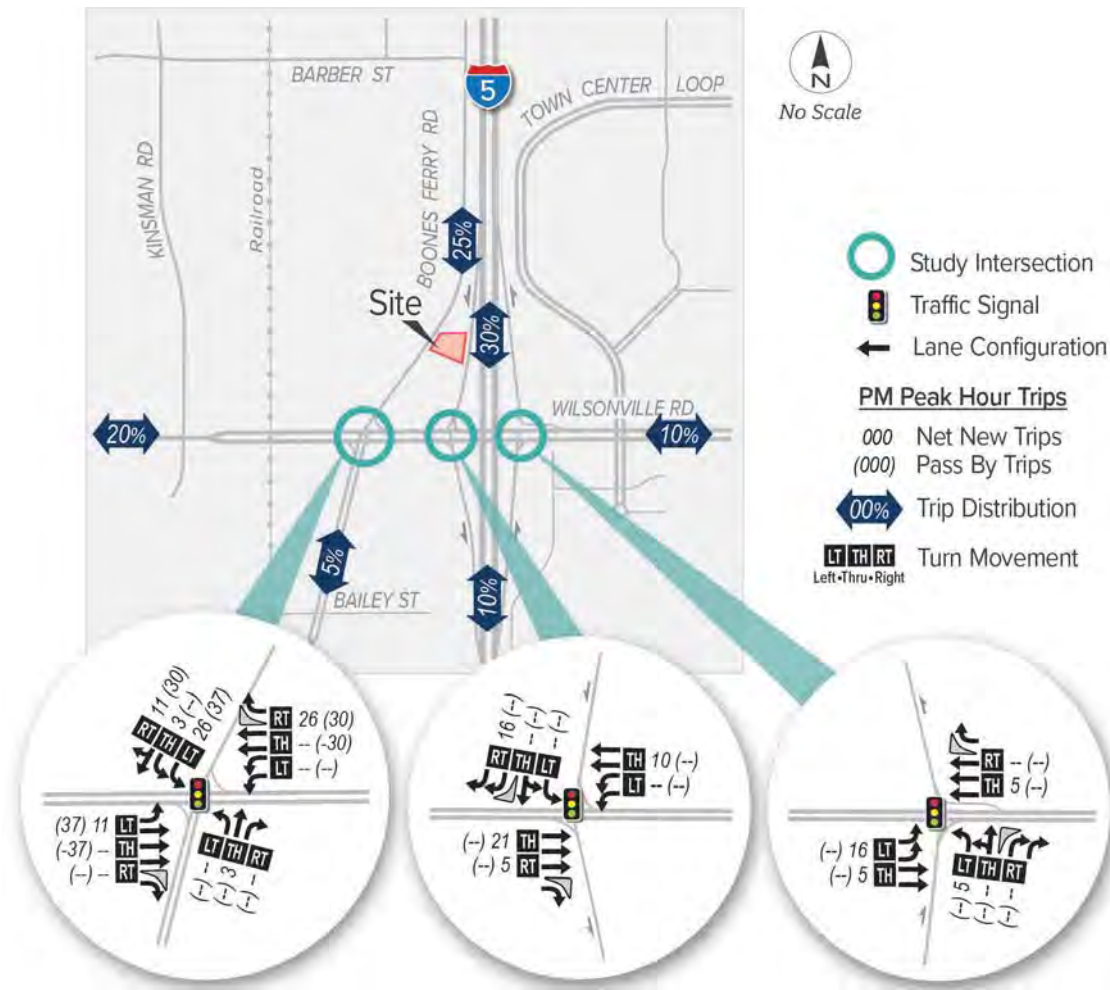

FIGURE 4: TRIP DISTRIBUTION AND PROJECT TRIPS

FUTURE TRAFFIC VOLUMES

Traffic volumes were estimated at the study intersections for the three future analysis scenarios. The future scenarios include various combinations of three types of traffic: Existing, Project, and Stage II. Stage II development trips are estimated based on the list of currently approved Stage II developments provided by City staff.⁷ The Stage II list is included in Appendix D. Figure 3, Figure 4, and Figure 5 show the PM peak hour traffic volumes for the following scenarios: Existing + Stage II, Existing + Project, Existing + Stage II + Project.



FIGURE 5: EXISTING + STAGE II PM PEAK HOUR TRAFFIC VOLUMES

⁷ Email from Daniel Pauly, City of Wilsonville, May 19, 2021.



FIGURE 6: EXISTING + PROJECT PM PEAK HOUR TRAFFIC VOLUMES

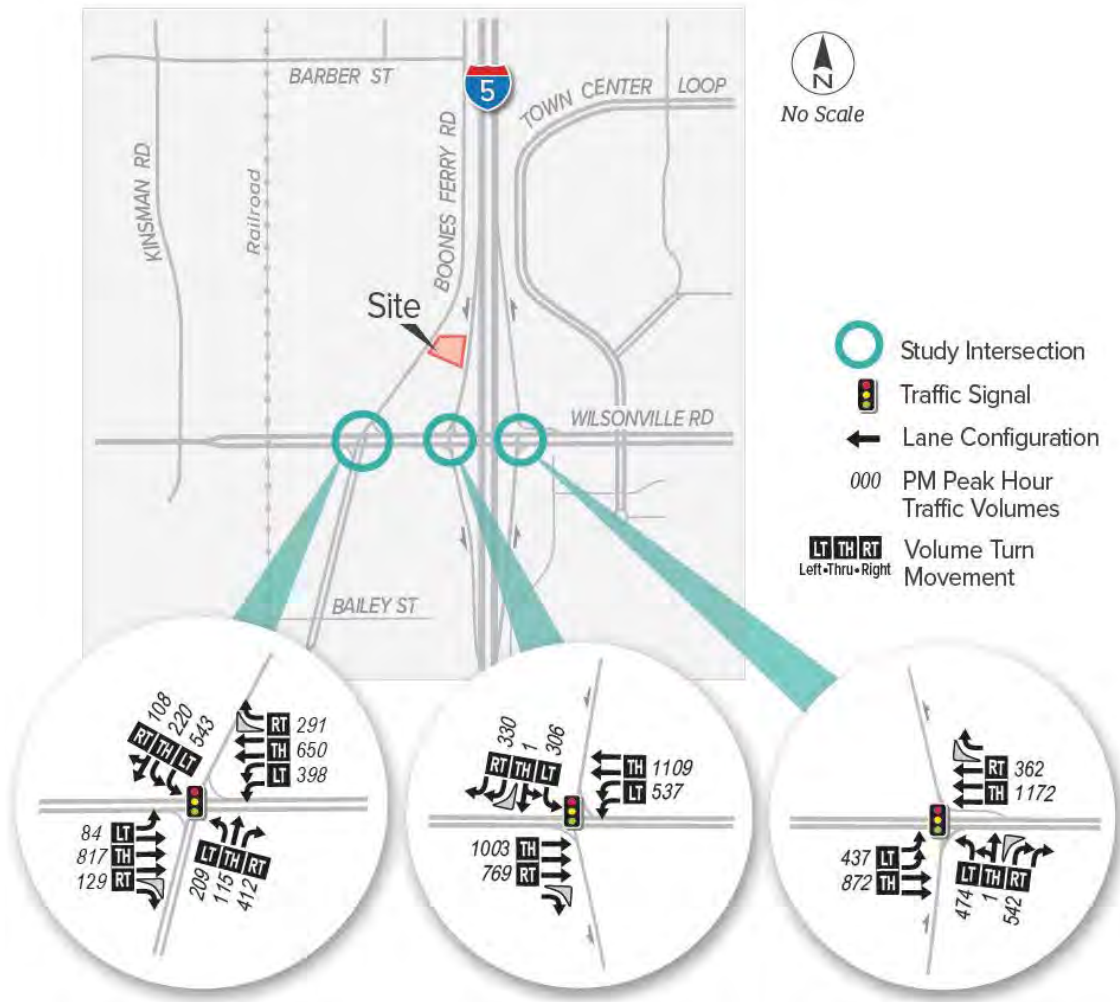

FIGURE 7: EXISTING + STAGE II + PROJECT PM PEAK HOUR TRAFFIC VOLUMES

FUTURE INTERSECTION OPERATIONS

Future operating conditions were analyzed based on the traffic volumes shown in Figure 3, Figure 4, and Figure 5. The intersection operations for the future scenarios are shown in Table 5. The HCM reports are provided in Appendix E, Appendix F, and Appendix G.

TABLE 5: FUTURE INTERSECTION OPERATIONS

INTERSECTION	OPERATING STANDARD/ MOBILITY TARGET	EXISTING + STAGE II			EXISTING + PROJECT			EXISTING + STAGE II + PROJECT		
		V/C	DELAY	LOS	V/C	DELAY	LOS	V/C	DELAY	LOS
UNSIGNALIZED										
SW WILSONVILLE ROAD/SW BOONES FERRY ROAD	LOS D	0.78	45.0	D	0.78	46.2	D	0.80	48.1	D
SW WILSONVILLE ROAD/I-5 SOUTHBOUND RAMP	V/c ≤ 0.90 ^a	0.49	24.7	C	0.48	22.7	C	0.50	24.9	C
SW WILSONVILLE ROAD/I-5 NORTHBOUND RAMP	V/c ≤ 0.90 ^a	0.55	21.2	C	0.53	20.7	C	0.56	21.5	C

Signalized intersections:

Delay = Average Stopped Delay per Vehicle (sec)
 LOS = Level of Service of Intersection
 v/c = Volume-to-Capacity Ratio of Intersection

^a The mobility target for ODOT interchanges is 0.90 when the interchange vicinity is fully developed, and adequate storage is available on the interchange ramp to prevent queues from backing up on the mainline, then the target can be increased to a 0.90 v/c ratio. Vehicle queues for this scenario were determined not to extend onto the I-5 mainline.

As shown, the study intersections are expected to meet the City's operating standard under both future analysis scenarios.

FUTURE QUEUING ANALYSIS

Based on ODOT analysis guidelines and procedures, 95th percentile queuing analysis is required to determine if the development will generate enough traffic to cause queuing and operational impacts to the I-5 interchange on SW Wilsonville Road. This queuing analysis will provide 95th percentile queues for the I-5 interchange ramps and will indicate whether vehicle queuing is anticipated to extend on to the I-5 mainline.

The 95th percentile queue is the queue length for a given movement that has only a 5% chance of being exceeded during the peak traffic hour. Table 6 show estimated the 95th percentile queues for select movements on SW Wilsonville Road under the Existing + Stage II + Project traffic conditions. If there are multiple lanes per movement, the queue reported is the average of the lanes. The queuing analysis was conducted using SimTraffic™ software and followed ODOT Analysis Procedures Manual (APM) methodology.⁸ Queuing reports can be found in Appendix H.

TABLE 6: FUTURE PM PEAK HOUR QUEUES

INTERSECTION	MOVEMENT	EXISTING + STAGE II + PROJECT	
		AVAILABLE STORAGE (FT)	95TH PERCENTILE QUEUES (FT)
SW WILSONVILLE ROAD / I-5 SB RAMPS	SB Off Ramp	475	250
	WBT	350	350
	WBL	350	325
SW WILSONVILLE ROAD / I-5 NB RAMPS	NB Off Ramp	350	300
	EBT	350	225
	EBL	350	225

Based on the results of the queuing analysis, the future vehicle queue estimates on the I-5 northbound and southbound exit ramps will be contained within the existing available storage. The Pacific Star gas station development will not impact the operations of I-5 during typical p.m. peak hour operations.

⁸ Analysis Procedures Manual, Chapter 15, Updated March 2020.

SITE REVIEW

The following sections discuss the requirements for site access and sight distance, pedestrian and bicycle facilities, and parking for the proposed development. The site plan is shown provided in Appendix I.

Based on the site plan provided, the proposed development will be accessed by an existing driveway that is located on the property directly to the south. The existing shared driveway currently provides access to the RAM Restaurant and Brewhouse. The only access to the project site is an internal driveway just north of the RAM Restaurant and Brewhouse driveway.

ACCESS SPACING

The existing shared driveway on SW Boones Ferry Road is required to meet the City's public works construction standards.⁹ The access spacing standard for an access on a Collector is to be a minimum 100 feet, but the desired spacing is 300 feet. The nearest existing access on SW Boones Ferry Road is 125 feet to the south on the opposite side of the street and therefore meets the minimum standard.

SIGHT DISTANCE

With a posted speed of 30 miles per hour, the assumed design speed of the roadway is 35 mph and the sight distance requirement along SW Boones Ferry Road is 390 feet in either direction for vehicles turning left from the minor roadway. This requirement is based on AASHTO standards.¹⁰ Preliminary sight distance was evaluated at the existing shared driveway location and was found to be sufficient to meet the stated requirements. Prior to occupancy, sight distance at any new or modified access points will need to be verified, documented, and stamped by a registered professional Civil or Traffic Engineer licensed in the State of Oregon.

SITE CIRCULATION

Based on the preliminary site plan provided, there does not appear to be sufficient turning radius for a fuel delivery truck to enter and exit the site via the existing shared driveway on SW Boones Ferry Road. It is recommended that a turn template be provided showing the entry and exit of fuel delivery trucks to determine if trucks can feasibly enter and exit the site from Boones Ferry Road and circulate through the site to access the tank fueling station. If the turning radius of the existing site driveway is not sufficient for fuel delivery trucks, internal site modifications may be needed.

Based on the preliminary sight plan, there is approximately 175 feet (or 7 vehicles) of queue storage on-site available for the drive-through window. Any queuing beyond the 175 feet will spill back onto the adjacent site (RAM Restaurant). Queues extending beyond 175 feet are not anticipated for the convenience store drive-through window as the service window was a design response to the COVID-19 lock down and it remains to be seen how much it will ultimately be

⁹ Table 2.12 Public Works Construction Standards, City of Wilsonville, 2017.

¹⁰ American Association of State Highway and Transportation Officials (AASHTO), 2018, Table 9-7.

used. If in the future, drive-through window queues are observed to consistently spill out of the project site on to Boones Ferry Road, mitigations may be needed to determine safety improvements at the site driveway.

PEDESTRIAN AND BICYCLE FACILITIES

Based on the project site plan, there are sidewalks proposed along SW Boones Ferry Road fronting the project site. Sidewalk is also shown extending from SW Boones Ferry Road on to the site, across the drive-through entry and exit points and then in front of the convenience market. The site plan shows the sidewalk that crosses the drive-through entry and exit points as a raised sidewalk. This increases pedestrian visibility and provide safer crossings for pedestrians at key vehicle-pedestrian conflict points on site.

Short-term bicycle parking is provided in front of the convenience market and existing bicycle lanes are present fronting the project site.

PARKING

The proposed project is required to comply with the City code for the number of vehicular parking stalls and bicycle parking spaces that are provided on site.¹¹ Table 7 lists the vehicular and bicycle parking requirements for the project site. The parking requirements are based on the building use.

TABLE 7: VEHICLE AND BICYCLE PARKING REQUIREMENTS

LAND USE	SIZE (KSF)	VEHICLE MINIMUM RATE	BICYCLE MINIMUM RATE	SPACES REQUIRED BY CODE		
				VEHICLE MINIMUM	VEHICLE MAXIMUM	BICYCLE MINIMUM
COMMERCIAL USES	3.46	4.1 stalls/KSF	1 stalls/4 KSF (minimum of 2)	15	21	2
TOTAL PARKING STALLS REQUIRED BY CODE				15	21	2
PROPOSED NUMBER OF STALLS				6		2

As shown above, a minimum of 15 vehicular parking stalls are needed to meet the minimum Code requirements for the project. The site plan shows 6 vehicular parking stalls on site, which does not meet the City code requirements. Nine (9) additional parking stalls will be needed.

The City code requires a minimum of 2 bicycle parking spaces for the project site. The site plan shows a single short-term bicycle rack in the front of the convenience market meeting the City requirements.

¹¹ Wilsonville Development Code, Section 4.155, Table 5, updated October 2019.

SUMMARY OF PROJECT IMPACTS

The key findings of the transportation impact study for the Pacific Star Gas Station development are discussed below.

- The project will consist of a 3,460 square-foot convenience market with a drive-through service window and 12 gasoline fueling stations.
- The proposed development is expected to generate a total of 240 PM peak hour trips (120 in, 120 out). However, it is estimated that approximately 56% of those trips will be existing pass-by trips. The total net new PM peak hour trips are 106 trips (53 in, 53 out).
- Of the net new project trips, 53 (50%) trips are expected to travel through the I-5/Wilsonville Road interchange area and 5 (<5%) trips are expected to travel through the I-5/Elligsen Road interchange area.
- The traffic operations at the three study intersections are expected to operate within the City's LOS D standard under project build conditions.
- Based on the results of the queuing analysis, the future vehicle queue estimates on the I-5 northbound and southbound exit ramps will be contained within the existing available storage.
- Prior to occupancy, sight distance at the proposed project access points will need to be verified, documented, and stamped by a registered professional Civil or Traffic Engineer licensed in the State of Oregon.
- Based on the site plan, there does not appear to be sufficient turning radius for a fuel delivery truck to enter and exit the site via the existing shared driveway on SW Boones Ferry Road. It is recommended that the developer provide a turn template showing the turning movements for fuel delivery trucks to determine if trucks can feasibly enter and exit the site or if modifications are required.
- The site plan shows 6 vehicular parking stalls on site, which does not meet the City code requirements. Nine (9) additional parking stalls will be needed.

APPENDIX

CONTENTS (SEE PDF ATTACHMENTS)

A. TRAFFIC COUNT DATA

B. LOS DESCRIPTION

C. HCM REPORT – EXISTING CONDITIONS

D. STAGE II LIST

E. HCM REPORT – EXISTING + PROJECT

F. HCM REPORT – EXISTING + STAGE II

G. HCM REPORT – EXISTING + STAGE II + PROJECT

H. QUEUING ANALYSIS REPORT

I. SITE PLAN

Data Provided by K-D-N.com 503-594-4224

N/S street	Boones Ferry Rd
E/W street	Wilsonville Rd
City, State	Wilsonville OR
Site Notes	
Location	45.302915 - -122.772598
Start Date	Thursday, May 09, 2019
Start Time	04:00:00 PM
Weather	
Study ID #	
Peak Hour Start	04:35:00 PM
Peak 15 Min Start	04:55:00 PM
PHF (15-Min Int)	0.95

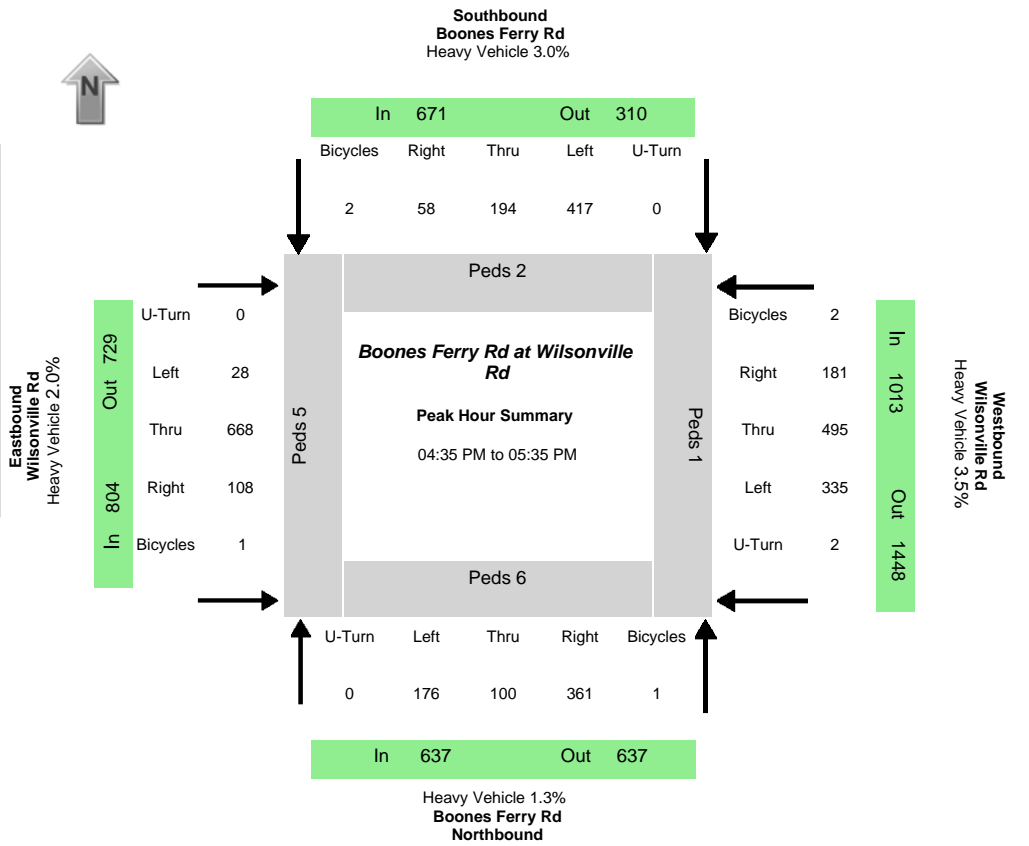

Peak-Hour Volumes (PHV)																							
Northbound				Southbound				Eastbound				Westbound				Entering				Leaving			
Left	Thru	Right	Uturn	Left	Thru	Right	Uturn	Left	Thru	Right	Uturn	Left	Thru	Right	Uturn	NB	SB	EB	WB	NB	SB	EB	WB
176	100	361	0	417	194	58	0	28	668	108	0	335	495	181	2	637	669	804	1013	637	309	729	1448
Percent Heavy Vehicles																							
0.0%	2.0%	1.7%	0.0%	3.4%	2.1%	3.4%	0.0%	3.6%	2.1%	0.9%	0.0%	1.5%	2.2%	11.0%	0.0%	1.3%	3.0%	2.0%	3.6%	1.6%	7.4%	1.8%	2.3%

PHV - Bicycles														PHV - Pedestrians							
Northbound				Southbound				Eastbound				Westbound				in Crosswalk				Sum	
Left	Thru	Right	Uturn	Left	Thru	Right	Uturn	Left	Thru	Right	Uturn	Left	Thru	Right	Uturn	Sum	NB	SB	EB	WB	Sum
1	0	0	0	0	1	1	0	0	1	0	0	0	1	1	0	6	6	2	5	1	14

Time	Northbound Boones Ferry Rd				Southbound Boones Ferry Rd				Eastbound Wilsonville Rd				Westbound Wilsonville Rd				15 Min Sum	1 HR Sum
	Left	Thru	Right	Uturn	Left	Thru	Right	Uturn	Left	Thru	Right	Uturn	Left	Thru	Right	Uturn		
04:00:00 PM	14	8	34	0	39	15	8	0	3	65	8	0	26	34	22	0		
04:05:00 PM	12	9	31	0	47	14	14	0	2	54	8	0	18	29	24	0		
04:10:00 PM	5	10	22	0	27	21	6	0	6	57	4	0	33	53	16	0	798	
04:15:00 PM	13	7	34	0	22	17	4	0	2	48	2	0	32	39	11	0	753	
04:20:00 PM	14	12	27	0	29	19	9	0	4	54	6	0	26	33	13	0	737	
04:25:00 PM	13	5	21	0	33	23	2	0	2	56	6	0	29	30	19	0	716	
04:30:00 PM	13	6	33	0	34	14	8	0	1	53	5	0	20	47	15	0	734	
04:35:00 PM	25	5	39	0	42	12	5	0	4	53	10	0	32	43	9	0	767	
04:40:00 PM	14	11	24	0	31	17	4	0	0	51	10	0	29	45	17	0	781	
04:45:00 PM	15	9	19	0	23	22	2	0	0	72	12	0	26	18	17	0	767	
04:50:00 PM	7	10	26	0	25	10	1	0	1	58	8	0	31	47	15	0	727	
04:55:00 PM	18	10	30	0	30	26	4	0	5	39	2	0	38	48	13	0	737	3032
05:00:00 PM	13	14	31	0	40	19	7	0	5	63	7	0	19	36	22	1	779	3033
05:05:00 PM	9	5	35	0	46	12	7	0	2	60	6	0	31	55	16	0	824	3055
05:10:00 PM	17	9	27	0	38	9	5	0	4	65	11	0	20	37	11	0	814	3048
05:15:00 PM	17	6	39	0	44	20	10	0	3	27	6	0	25	42	15	0	791	3071
05:20:00 PM	13	4	31	0	45	18	8	0	0	66	13	0	24	41	16	0	786	3104
05:25:00 PM	13	5	32	0	26	16	3	0	3	58	10	0	34	39	13	1	786	3118
05:30:00 PM	15	12	28	0	27	13	2	0	1	56	13	0	26	44	17	0	786	3123
05:35:00 PM	18	5	33	0	43	20	3	0	2	48	9	0	25	25	12	0	750	3087
05:40:00 PM	14	7	17	0	24	17	7	0	1	56	9	0	26	38	18	0	731	3068
05:45:00 PM	14	7	37	0	14	12	4	0	5	53	10	0	33	52	22	0	740	3096
05:50:00 PM	23	11	37	0	21	17	3	0	4	41	10	0	24	30	21	0	739	3099
05:55:00 PM	15	7	26	0	38	18	1	0	0	47	9	0	24	38	19	0	747	3078



KEY DATA NETWORK

Data Provided by K-D-N.com 503-594-4224

Study Name	Wilsonville Rd at I5 NB ramps
Location	45.302952 - -122.768422
Start Date	11/3/2016
Start Time	4:00PM
Key Data Summary	
Peak Hour Start	4:40PM
Peak 15 Min Start	4:40PM
PHF (15-Min Int)	0.97

PEAK-HOUR VOLUMES

NBLeft	NBThru	NBRt	SBLeft	SBThru	SBRt	EBLeft	EBThru	EBRt	WBLeft	WBThru	WBRt	NBEnt	SBEnt	EBEnt	WBEnt	NBLeav	SBLeav	EBLeav	WBLeav
395	1	489	0	0	0	360	618	0	0	1043	326	0	687	1438	1107	885	0	978	1369

PERCENT HEAVY VEHICLES

NBLeft	NBThru	NBRt	SBLeft	SBThru	SBRt	EBLeft	EBThru	EBRt	WBLeft	WBThru	WBRt	NBEnt	SBEnt	EBEnt	WBEnt	NBLeav	SBLeav	EBLeav	WBLeav
5.5%	0.0%	0.6%	0.0%	0.0%	0.0%	0.0	1.3%	0.0%	0.0%	1.0%	1.8%	0.0%	2.5%	2.2%	1.0%	2.8%	0.0%	1.9%	1.2%

PHV- Pedestrians using Crosswalk

NB	SB	EB	WB
5	23	0	2

PEAK-HOUR VOLUMES- BICYCLES

NBLeft	NBThru	NBRt	SBLeft	SBThru	SBRt	EBLeft	EBThru	EBRt	WBLeft	WBThru	WBRt
2	0	0	0	0	0	0	0	0	0	1	0

All Vehicle Volumes

Start	Northbound				Southbound				Eastbound				Westbound			
	I5 NB off ramp				I5 NB on ramp				Wilsonville Rd				Wilsonville Rd			
Time	Left	Thru	Right	U-Turn	Left	Thru	Right	U-Turn	Left	Thru	Right	U-Turn	Left	Thru	Right	U-Turn
4:00PM	22	0	30	0	0	0	0	0	24	53	0	1	0	61	22	0
4:05PM	19	0	24	0	0	0	0	0	52	66	0	0	0	95	30	0
4:10PM	27	0	32	0	0	0	0	0	28	51	0	0	0	90	28	0
4:15PM	45	0	37	0	0	0	0	0	40	44	0	0	0	89	24	0
4:20PM	26	0	38	0	0	0	0	0	29	67	0	0	0	74	32	0
4:25PM	28	0	33	0	0	0	0	0	34	51	0	0	0	82	14	0
4:30PM	34	0	40	0	0	0	0	0	23	46	0	0	0	75	27	0
4:35PM	33	0	43	0	0	0	0	0	31	38	0	0	0	63	27	0
4:40PM	26	0	47	0	0	0	0	0	39	44	0	0	0	95	31	0
4:45PM	35	0	38	0	0	0	0	0	25	47	0	0	0	96	21	0
4:50PM	39	0	55	0	0	0	0	0	36	47	0	0	0	86	24	0
4:55PM	23	0	47	0	0	0	0	0	28	48	0	0	0	76	28	0
5:00PM	26	0	27	0	0	0	0	0	35	62	0	0	0	104	35	0
5:05PM	30	0	33	0	0	0	0	0	25	55	0	0	0	95	38	0
5:10PM	39	0	35	0	0	0	0	0	31	54	0	0	0	77	26	0
5:15PM	34	0	45	0	0	0	0	0	27	56	0	0	0	64	26	0
5:20PM	41	0	36	0	0	0	0	0	22	58	0	0	0	86	21	0
5:25PM	32	0	37	0	0	0	0	0	37	54	0	0	0	101	29	0
5:30PM	36	1	53	0	0	0	0	0	33	53	0	0	0	73	22	0
5:35PM	34	0	36	0	0	0	0	0	22	40	0	0	0	90	25	0
5:40PM	41	0	34	0	0	0	0	0	14	60	0	0	0	102	28	0
5:45PM	31	0	33	0	0	0	0	0	29	66	0	0	0	77	20	0
5:50PM	32	0	34	0	0	0	0	0	35	45	0	0	0	66	15	0
5:55PM	19	0	33	0	0	0	0	0	33	54	0	0	0	84	18	0



KEY DATA NETWORK

Data Provided by K-D-N.com 503-594-4224

Study Name	Wilsonville Rd at I5 SB ramp
Location	45.30299 - -122.770351
Start Date	11/3/2016
Start Time	4:00PM
Key Data Summary	
Peak Hour Start	4:35PM
Peak 15 Min Start	4:35PM
PHF (15-Min Int)	0.97

PEAK-HOUR VOLUMES

NBLeft	NBThru	NBRt	SBLeft	SBThru	SBRt	EBLeft	EBThru	EBRt	WBLeft	WBThru	WBRt	NBEnt	SBEnt	EBEnt	WBEnt	NBLeav	SBLeav	EBLeav	WBLeav
0	0	0	138	0	178	0	842	664	485	938	0	1149	0	1116	980	0	316	1506	1423

PERCENT HEAVY VEHICLES

NBLeft	NBThru	NBRt	SBLeft	SBThru	SBRt	EBLeft	EBThru	EBRt	WBLeft	WBThru	WBRt	NBEnt	SBEnt	EBEnt	WBEnt	NBLeav	SBLeav	EBLeav	WBLeav
0.0%	0.0%	0.0%	1.4%	0.0%	6.7%	0.0	1.9%	2.1%	0.8%	2.8%	0.0%	1.6%	#DIV/0!	3.4%	1.8%	0.0%	4.4%	2.0%	2.1%

PHV- Pedestrians using Crosswalk

NB	SB	EB	WB
7	8	3	1

PEAK-HOUR VOLUMES- BICYCLES

NBLeft	NBThru	NBRt	SBLeft	SBThru	SBRt	EBLeft	EBThru	EBRt	WBLeft	WBThru	WBRt
0	0	0	0	0	0	0	0	0	0	4	0

All Vehicle Volumes

Start	Northbound				Southbound				Eastbound				Westbound			
	I5 SB on ramp				I5 SB off ramp				Wilsonville Rd				Wilsonville Rd			
Time	Left	Thru	Right	U-Turn	Left	Thru	Right	U-Turn	Left	Thru	Right	U-Turn	Left	Thru	Right	U-Turn
4:00PM	0	0	0	0	13	0	16	0	0	83	56	0	43	64	0	0
4:05PM	0	0	0	0	10	0	15	0	0	93	63	0	50	65	0	0
4:10PM	0	0	0	0	14	0	7	0	0	62	54	0	48	56	0	0
4:15PM	0	0	0	0	10	0	19	0	0	85	60	0	35	85	0	0
4:20PM	0	0	0	0	12	0	16	0	0	83	49	0	41	81	0	0
4:25PM	0	0	0	0	12	0	12	0	0	51	52	0	41	65	0	0
4:30PM	0	0	0	0	11	0	9	0	0	64	49	0	28	61	0	0
4:35PM	0	0	0	0	10	0	20	0	0	74	89	0	28	84	0	0
4:40PM	0	0	0	0	8	0	13	0	0	63	51	0	47	77	0	0
4:45PM	0	0	0	0	14	0	8	0	0	59	51	0	49	89	0	0
4:50PM	0	0	0	0	11	0	27	0	0	68	45	0	33	66	0	0
4:55PM	0	0	0	0	10	0	11	0	0	76	33	0	43	78	0	0
5:00PM	0	0	0	0	10	0	14	0	0	78	55	0	54	78	0	0
5:05PM	0	0	0	0	15	0	16	0	0	63	62	0	43	67	0	1
5:10PM	0	0	0	0	13	0	9	0	0	78	58	0	23	76	0	0
5:15PM	0	0	0	0	11	0	15	0	0	74	52	0	41	94	0	0
5:20PM	0	0	0	0	13	0	15	0	0	63	53	0	42	66	0	0
5:25PM	0	0	0	0	10	0	18	0	0	82	60	0	49	70	0	0
5:30PM	0	0	0	0	13	0	12	0	0	64	55	0	33	93	0	0
5:35PM	0	0	0	0	12	0	25	0	0	56	46	0	44	90	0	0
5:40PM	0	0	0	0	15	0	15	0	0	58	48	0	44	82	0	0
5:45PM	0	0	0	0	22	0	9	0	0	67	38	0	25	63	0	0
5:50PM	0	0	0	0	10	0	15	0	0	81	40	0	38	82	0	0
5:55PM	0	0	0	0	7	0	22	0	0	70	40	0	44	57	0	0

TRAFFIC LEVELS OF SERVICE

Analysis of traffic volumes is useful in understanding the general nature of traffic in an area, but by itself indicates neither the ability of the street network to carry additional traffic nor the quality of service afforded by the street facilities. For this, the concept of level of service has been developed to subjectively describe traffic performance. Level of service can be measured at intersections and along key roadway segments.

Levels of service categories are similar to report card ratings for traffic performance. Intersections are typically the controlling bottlenecks of traffic flow and the ability of a roadway system to carry traffic efficiently is generally diminished in their vicinities. Levels of Service A, B and C indicate conditions where traffic moves without significant delays over periods of peak travel demand. Level of service D and E are progressively worse peak hour operating conditions and F conditions represent where demand exceeds the capacity of an intersection. Most urban communities set level of service D as the minimum acceptable level of service for peak hour operation and plan for level of service C or better for all other times of the day. The Highway Capacity Manual provides level of service calculation methodology for both intersections and arterials¹. The following two sections provide interpretations of the analysis approaches.

¹ *2000 Highway Capacity Manual*, Transportation Research Board, Washington D.C., 2000, Chapter 16 and 17.

UNSIGNALIZED INTERSECTIONS (Two-Way Stop Controlled)

Unsignalized intersection level of service is reported for the major street and minor street (generally, left turn movements). The method assesses available and critical gaps in the traffic stream which make it possible for side street traffic to enter the main street flow. The 2010 Highway Capacity Manual describes the detailed methodology. It is not unusual for an intersection to experience level of service E or F conditions for the minor street left turn movement. It should be understood that, often, a poor level of service is experienced by only a few vehicles and the intersection as a whole operates acceptably.

Unsignalized intersection levels of service are described in the following table.

Level-of-Service Criteria: Automobile Mode

Control Delay (s/vehicle)	LOS by Volume-to-Capacity Ratio	
	$v/c \leq 1.0$	$v/c > 1.0$
0-10	A	F
>10-15	B	F
>15-25	C	F
>25-35	D	F
>35-50	E	F
>50	F	F

Note: The LOS criteria apply to each lane on a given approach and to each approach on the minor street.
LOS is not calculated for major-street approaches or for the intersection as a whole

SIGNALIZED INTERSECTIONS































For signalized intersections, level of service is evaluated based upon average vehicle delay experienced by vehicles entering an intersection. Control delay (or signal delay) includes initial deceleration delay, queue move-up time, stopped delay, and final acceleration delay. In previous versions of this chapter of the HCM (1994 and earlier), delay included only stopped delay. As delay increases, the level of service decreases. Calculations for signalized and unsignalized intersections are different due to the variation in traffic control. The 2000 Highway Capacity Manual provides the basis for these calculations.

Level of Service	Delay (secs.)	Description
A	<10.00	Free Flow/Insignificant Delays: No approach phase is fully utilized by traffic and no vehicle waits longer than one red indication. Most vehicles do not stop at all. Progression is extremely favorable and most vehicles arrive during the green phase.
B	10.1-20.0	Stable Operation/Minimal Delays: An occasional approach phase is fully utilized. Many drivers begin to feel somewhat restricted within platoons of vehicles. This level generally occurs with good progression, short cycle lengths, or both.
C	20.1-35.0	Stable Operation/Acceptable Delays: Major approach phases fully utilized. Most drivers feel somewhat restricted. Higher delays may result from fair progression, longer cycle lengths, or both. Individual cycle failures may begin to appear at this level, and the number of vehicles stopping is significant.
D	35.1-55.0	Approaching Unstable/Tolerable Delays: The influence of congestion becomes more noticeable. Drivers may have to wait through more than one red signal indication. Longer delays may result from some combination of unfavorable progression, long cycle lengths, or high v/c ratios. The proportion of vehicles not stopping declines, and individual cycle failures are noticeable.
E	55.1-80.0	Unstable Operation/Significant Delays: Volumes at or near capacity. Vehicles may wait through several signal cycles. Long queues form upstream from intersection. These high delay values generally indicate poor progression, long cycle lengths, and high v/c ratios. Individual cycle failures are a frequent occurrence.
F	>80.0	Forced Flow/Excessive Delays: Represents jammed conditions. Queues may block upstream intersections. This level occurs when arrival flow rates exceed intersection capacity, and is considered to be unacceptable to most drivers. Poor progression, long cycle lengths, and v/c ratios approaching 1.0 may contribute to these high delay levels.

Source: 2000 Highway Capacity Manual, Transportation Research Board, Washington D.C.

HCM Signalized Intersection Capacity Analysis
1: Boones Ferry Rd & Wilsonville Rd





























Wilsonville Pacific Star Gas Station TIA
Existing PM Peak Hour

												
Movement	EBL	EBT	EBR	WBL	WBT	WBR	NBL	NBT	NBR	SBL	SBT	SBR
Lane Configurations		  		 	 					 	 	
Traffic Volume (vph)	31	785	119	389	631	224	194	110	407	464	213	64
Future Volume (vph)	31	785	119	389	631	224	194	110	407	464	213	64
Ideal Flow (vphpl)	1900	1900	1900	1900	1900	1900	1900	1900	1900	1900	1900	1900
Lane Width	12	12	12	12	12	16	12	12	12	12	12	12
Total Lost time (s)	5.0	5.0	5.0	5.0	5.0	4.0	5.0	5.0	5.0	5.0	5.0	5.0
Lane Util. Factor	1.00	0.91	1.00	0.97	0.95	1.00	1.00	1.00	1.00	0.97	1.00	1.00
Frpb, ped/bikes	1.00	1.00	0.98	1.00	1.00	0.97	1.00	1.00	0.99	1.00	1.00	1.00
Flpb, ped/bikes	1.00	1.00	1.00	1.00	1.00	1.00	1.00	1.00	1.00	1.00	1.00	1.00
Frt	1.00	1.00	0.85	1.00	1.00	0.85	1.00	1.00	0.85	1.00	0.97	1.00
Flt Protected	0.95	1.00	1.00	0.95	1.00	1.00	0.95	1.00	1.00	0.95	1.00	1.00
Satd. Flow (prot)	1736	5085	1566	3467	3539	1606	1805	1863	1573	3400	1786	1786
Flt Permitted	0.95	1.00	1.00	0.95	1.00	1.00	0.95	1.00	1.00	0.95	1.00	1.00
Satd. Flow (perm)	1736	5085	1566	3467	3539	1606	1805	1863	1573	3400	1786	1786
Peak-hour factor, PHF	0.95	0.95	0.95	0.95	0.95	0.95	0.95	0.95	0.95	0.95	0.95	0.95
Adj. Flow (vph)	33	826	125	409	664	236	204	116	428	488	224	67
RTOR Reduction (vph)	0	0	0	0	0	0	0	0	0	0	10	0
Lane Group Flow (vph)	33	826	125	409	664	236	204	116	428	488	281	0
Confl. Peds. (#/hr)	2		6	6		2	5		1	1		5
Confl. Bikes (#/hr)			1			2			1			2
Heavy Vehicles (%)	4%	2%	1%	1%	2%	11%	0%	2%	2%	3%	2%	3%
Turn Type	Prot	NA	Perm	Prot	NA	Perm	Split	NA	pm+ov	Split	NA	
Protected Phases	5	2		1	6		8	8	1	4	4	
Permitted Phases			2			6			8			
Actuated Green, G (s)	4.8	31.8	31.8	19.5	46.5	46.5	17.2	17.2	36.7	21.5	21.5	
Effective Green, g (s)	4.8	31.8	31.8	19.5	46.5	47.5	17.2	17.2	36.7	21.5	21.5	
Actuated g/C Ratio	0.04	0.29	0.29	0.18	0.42	0.43	0.16	0.16	0.33	0.20	0.20	
Clearance Time (s)	5.0	5.0	5.0	5.0	5.0	5.0	5.0	5.0	5.0	5.0	5.0	
Vehicle Extension (s)	2.3	4.1	4.1	2.3	4.1	4.1	2.3	2.3	2.3	2.3	2.3	
Lane Grp Cap (vph)	75	1470	452	614	1496	693	282	291	596	664	349	
v/s Ratio Prot	0.02	c0.16		0.12	0.19		0.11	0.06	c0.13	0.14	c0.16	
v/s Ratio Perm			0.08			0.15			0.14			
v/c Ratio	0.44	0.56	0.28	0.67	0.44	0.34	0.72	0.40	0.72	0.73	0.80	
Uniform Delay, d1	51.3	33.2	30.2	42.2	22.6	20.8	44.1	41.7	32.1	41.6	42.2	
Progression Factor	1.00	1.00	1.00	1.01	0.79	0.76	1.00	1.00	1.00	1.00	1.00	
Incremental Delay, d2	2.4	1.6	1.5	2.2	0.9	1.3	8.0	0.5	3.7	3.9	12.1	
Delay (s)	53.7	34.7	31.7	44.8	18.8	17.2	52.2	42.3	35.8	45.4	54.4	
Level of Service	D	C	C	D	B	B	D	D	D	D	D	
Approach Delay (s)		35.0			26.6			41.3			48.8	
Approach LOS		C			C			D			D	
Intersection Summary												
HCM 2000 Control Delay			36.2				HCM 2000 Level of Service			D		
HCM 2000 Volume to Capacity ratio			0.72									
Actuated Cycle Length (s)			110.0				Sum of lost time (s)			20.0		
Intersection Capacity Utilization			75.1%				ICU Level of Service			D		
Analysis Period (min)			15									

c Critical Lane Group













HCM 6th Signalized Intersection Summary
1: Boones Ferry Rd & Wilsonville Rd

Wilsonville Pacific Star Gas Station TIA
Existing PM Peak Hour

												
Movement	EBL	EBT	EBR	WBL	WBT	WBR	NBL	NBT	NBR	SBL	SBT	SBR
Lane Configurations		  		 	 					 		
Traffic Volume (veh/h)	31	785	119	389	631	224	194	110	407	464	213	64
Future Volume (veh/h)	31	785	119	389	631	224	194	110	407	464	213	64
Initial Q (Qb), veh	0	0	0	0	0	0	0	0	0	0	0	0
Ped-Bike Adj(A_pbT)	1.00		1.00	1.00		1.00	1.00		0.98	1.00		0.98
Parking Bus, Adj	1.00	1.00	1.00	1.00	1.00	1.00	1.00	1.00	1.00	1.00	1.00	1.00
Work Zone On Approach		No			No			No			No	
Adj Sat Flow, veh/h/ln	1841	1870	1885	1885	1870	1806	1900	1870	1870	1856	1870	1856
Adj Flow Rate, veh/h	33	826	0	409	664	0	204	116	428	488	224	56
Peak Hour Factor	0.95	0.95	0.95	0.95	0.95	0.95	0.95	0.95	0.95	0.95	0.95	0.95
Percent Heavy Veh, %	4	2	1	1	2	11	0	2	2	3	2	3
Cap, veh/h	41	1257		412	1212		479	495	599	648	272	68
Arrive On Green	0.02	0.25	0.00	0.08	0.23	0.00	0.26	0.26	0.26	0.19	0.19	0.19
Sat Flow, veh/h	1753	5106	1598	3483	3554	1531	1810	1870	1556	3428	1437	359
Grp Volume(v), veh/h	33	826	0	409	664	0	204	116	428	488	0	280
Grp Sat Flow(s),veh/h/ln	1753	1702	1598	1742	1777	1531	1810	1870	1556	1714	0	1796
Q Serve(g_s), s	2.1	16.0	0.0	12.9	18.1	0.0	10.3	5.3	25.8	14.8	0.0	16.5
Cycle Q Clear(g_c), s	2.1	16.0	0.0	12.9	18.1	0.0	10.3	5.3	25.8	14.8	0.0	16.5
Prop In Lane	1.00		1.00	1.00		1.00	1.00		1.00	1.00		0.20
Lane Grp Cap(c), veh/h	41	1257		412	1212		479	495	599	648	0	340
V/C Ratio(X)	0.80	0.66		0.99	0.55		0.43	0.23	0.71	0.75	0.00	0.82
Avail Cap(c_a), veh/h	112	1257		412	1212		526	544	640	841	0	441
HCM Platoon Ratio	1.00	1.00	1.00	0.67	0.67	0.67	1.00	1.00	1.00	1.00	1.00	1.00
Upstream Filter(l)	1.00	1.00	0.00	0.91	0.91	0.00	1.00	1.00	1.00	1.00	0.00	1.00
Uniform Delay (d), s/veh	53.5	37.3	0.0	50.6	35.0	0.0	33.5	31.7	28.9	42.2	0.0	42.9
Incr Delay (d2), s/veh	19.1	2.7	0.0	40.5	1.6	0.0	0.4	0.1	3.1	2.2	0.0	8.3
Initial Q Delay(d3),s/veh	0.0	0.0	0.0	0.0	0.0	0.0	0.0	0.0	0.0	0.0	0.0	0.0
%ile BackOfQ(50%),veh/ln	1.1	6.9	0.0	8.1	8.4	0.0	4.5	2.4	9.9	6.4	0.0	8.0
Unsig. Movement Delay, s/veh			31.70			17.20						
LnGrp Delay(d),s/veh	72.6	40.0	31.7	91.1	36.6	17.2	33.9	31.8	32.0	44.4	0.0	51.1
LnGrp LOS	E	D	C	F	D	B	C	C	C	D	A	D
Approach Vol, veh/h		984	A		1309	A		748			768	
Approach Delay, s/veh		40.0			50.1			32.5			46.9	
Approach LOS		D			D			C			D	
Timer - Assigned Phs	1	2		4	5	6		8				
Phs Duration (G+Y+Rc), s	18.0	32.1		25.8	7.6	42.5		34.1				
Change Period (Y+Rc), s	5.0	5.0		5.0	5.0	5.0		5.0				
Max Green Setting (Gmax), s	13.0	18.0		27.0	7.0	24.0		32.0				
Max Q Clear Time (g_c+I1), s	14.9	18.0		18.5	4.1	20.1		27.8				
Green Ext Time (p_c), s	0.0	0.0		1.8	0.0	1.6		1.1				
Intersection Summary												
HCM 6th Ctrl Delay			43.4									
HCM 6th LOS			D									
Notes												
User approved pedestrian interval to be less than phase max green.												
User approved changes to right turn type.												
Unsignalized Delay for [EBR, WBR] is included in calculations of the approach delay and intersection delay.												













HCM Signalized Intersection Capacity Analysis
2: I-5 SB & Wilsonville Rd

Wilsonville Pacific Star Gas Station TIA
Existing PM Peak Hour

												
Movement	EBL	EBT	EBR	WBL	WBT	WBR	NBL	NBT	NBR	SBL	SBT	SBR
Lane Configurations		↑↑↑	↑	↑↑	↑↑					↑	↑	↑↑
Traffic Volume (vph)	0	926	730	534	1048	0	0	0	0	302	1	296
Future Volume (vph)	0	926	730	534	1048	0	0	0	0	302	1	296
Ideal Flow (vphpl)	1900	1900	1900	1900	1900	1900	1900	1900	1900	1900	1900	1900
Total Lost time (s)		4.0	4.0	4.0	4.0					4.0	4.0	4.0
Lane Util. Factor		0.91	1.00	0.97	0.95					0.95	0.95	0.88
Frbp, ped/bikes		1.00	0.97	1.00	1.00					1.00	1.00	0.98
Flpb, ped/bikes		1.00	1.00	1.00	1.00					1.00	1.00	1.00
Frt		1.00	0.85	1.00	1.00					1.00	1.00	0.85
Flt Protected		1.00	1.00	0.95	1.00					0.95	0.95	1.00
Satd. Flow (prot)		5085	1543	3467	3505					1698	1703	2598
Flt Permitted		1.00	1.00	0.95	1.00					0.95	0.95	1.00
Satd. Flow (perm)		5085	1543	3467	3505					1698	1703	2598
Peak-hour factor, PHF	0.97	0.97	0.97	0.97	0.97	0.97	0.97	0.97	0.97	0.97	0.97	0.97
Adj. Flow (vph)	0	955	753	551	1080	0	0	0	0	311	1	305
RTOR Reduction (vph)	0	0	0	0	0	0	0	0	0	0	0	207
Lane Group Flow (vph)	0	955	753	551	1080	0	0	0	0	155	157	98
Confl. Peds. (#/hr)	7		8	8		7	1		3	3		1
Confl. Bikes (#/hr)						4						
Heavy Vehicles (%)	0%	2%	2%	1%	3%	0%	0%	0%	0%	1%	0%	7%
Turn Type		NA	Perm	Prot	NA					Split	NA	Perm
Protected Phases		2		1	6					4	4	
Permitted Phases			2		6							4
Actuated Green, G (s)		59.9	59.9	22.3	86.7					14.8	14.8	14.8
Effective Green, g (s)		59.9	59.9	22.8	86.7					15.3	15.3	15.3
Actuated g/C Ratio		0.54	0.54	0.21	0.79					0.14	0.14	0.14
Clearance Time (s)		4.0	4.0	4.5	4.0					4.5	4.5	4.5
Vehicle Extension (s)		5.2	5.2	2.3	5.2					2.3	2.3	2.3
Lane Grp Cap (vph)		2769	840	718	2762					236	236	361
v/s Ratio Prot		0.19		c0.16	0.31					0.09	c0.09	
v/s Ratio Perm			c0.49									0.04
v/c Ratio		0.34	0.90	0.77	0.39					0.66	0.67	0.27
Uniform Delay, d1		14.0	22.3	41.1	3.6					44.9	44.9	42.4
Progression Factor		1.14	1.17	1.19	0.95					1.00	1.00	1.00
Incremental Delay, d2		0.3	11.5	4.2	0.4					5.4	5.9	0.2
Delay (s)		16.3	37.7	53.1	3.8					50.3	50.8	42.6
Level of Service		B	D	D	A					D	D	D
Approach Delay (s)		25.8			20.4			0.0			46.6	
Approach LOS		C			C			A			D	
Intersection Summary												
HCM 2000 Control Delay			26.8			HCM 2000 Level of Service				C		
HCM 2000 Volume to Capacity ratio			0.83									
Actuated Cycle Length (s)			110.0			Sum of lost time (s)				12.0		
Intersection Capacity Utilization			80.1%			ICU Level of Service				D		
Analysis Period (min)			15									
c	Critical Lane Group											

HCM 6th Signalized Intersection Summary
2: I-5 SB & Wilsonville Rd

























Wilsonville Pacific Star Gas Station TIA
Existing PM Peak Hour

												
Movement	EBL	EBT	EBR	WBL	WBT	WBR	NBL	NBT	NBR	SBL	SBT	SBR
Lane Configurations		↑↑↑	↗	↗↘	↑↑					↘	↖	↗↘
Traffic Volume (veh/h)	0	926	730	534	1048	0	0	0	0	302	1	296
Future Volume (veh/h)	0	926	730	534	1048	0	0	0	0	302	1	296
Initial Q (Qb), veh	0	0	0	0	0	0				0	0	0
Ped-Bike Adj(A_pbT)	1.00		1.00	1.00		1.00				1.00		0.99
Parking Bus, Adj	1.00	1.00	1.00	1.00	1.00	1.00				1.00	1.00	1.00
Work Zone On Approach		No			No						No	
Adj Sat Flow, veh/h/ln	0	1870	1870	1885	1856	0				1885	1900	1796
Adj Flow Rate, veh/h	0	955	0	551	1080	0				312	0	92
Peak Hour Factor	0.97	0.97	0.97	0.97	0.97	0.97				0.97	0.97	0.97
Percent Heavy Veh, %	0	2	2	1	3	0				1	0	7
Cap, veh/h	0	3066		586	2838	0				439	0	368
Arrive On Green	0.00	1.00	0.00	0.34	1.00	0.00				0.12	0.00	0.12
Sat Flow, veh/h	0	5274	1585	3483	3618	0				3591	0	3007
Grp Volume(v), veh/h	0	955	0	551	1080	0				312	0	92
Grp Sat Flow(s),veh/h/ln	0	1702	1585	1742	1763	0				1795	0	1504
Q Serve(g_s), s	0.0	0.0	0.0	16.9	0.0	0.0				9.2	0.0	3.0
Cycle Q Clear(g_c), s	0.0	0.0	0.0	16.9	0.0	0.0				9.2	0.0	3.0
Prop In Lane	0.00		1.00	1.00		0.00				1.00		1.00
Lane Grp Cap(c), veh/h	0	3066		586	2838	0				439	0	368
V/C Ratio(X)	0.00	0.31		0.94	0.38	0.00				0.71	0.00	0.25
Avail Cap(c_a), veh/h	0	3066		586	2838	0				832	0	697
HCM Platoon Ratio	1.00	2.00	2.00	2.00	2.00	1.00				1.00	1.00	1.00
Upstream Filter(I)	0.00	0.69	0.00	0.88	0.88	0.00				1.00	0.00	1.00
Uniform Delay (d), s/veh	0.0	0.0	0.0	36.0	0.0	0.0				46.4	0.0	43.7
Incr Delay (d2), s/veh	0.0	0.2	0.0	21.4	0.3	0.0				1.3	0.0	0.2
Initial Q Delay(d3),s/veh	0.0	0.0	0.0	0.0	0.0	0.0				0.0	0.0	0.0
%ile BackOfQ(50%),veh/ln	0.0	0.1	0.0	7.4	0.1	0.0				4.2	0.0	1.1
Unsig. Movement Delay, s/veh			37.70									
LnGrp Delay(d),s/veh	0.0	0.2	37.7	57.3	0.3	0.0				47.7	0.0	43.9
LnGrp LOS	A	A	D	E	A	A				D	A	D
Approach Vol, veh/h		1708		A	1631					404		
Approach Delay, s/veh		16.7			19.6					46.9		
Approach LOS		B			B					D		
Timer - Assigned Phs	1	2		4		6						
Phs Duration (G+Y+Rc), s	22.5	70.1		17.4		92.6						
Change Period (Y+Rc), s	4.5	4.0		4.5		4.0						
Max Green Setting (Gmax), s	18.0	54.0		25.0		76.5						
Max Q Clear Time (g_c+I1), s	18.9	2.0		11.2		2.0						
Green Ext Time (p_c), s	0.0	13.5		1.2		18.0						
Intersection Summary												
HCM 6th Ctrl Delay			21.2									
HCM 6th LOS			C									
Notes												
User approved pedestrian interval to be less than phase max green.												
User approved volume balancing among the lanes for turning movement.												
User approved changes to right turn type.												

Unsignalized Delay for [EBR] is included in calculations of the approach delay and intersection delay.

























HCM Signalized Intersection Capacity Analysis
3: I-5 NB & Wilsonville Rd

Wilsonville Pacific Star Gas Station TIA
Existing PM Peak Hour

													
Movement	EBL	EBT	EBR	WBL	WBT	WBR	NBL	NBT	NBR	SBL	SBT	SBR	
Lane Configurations	 	 			  				 				
Traffic Volume (vph)	396	832	0	0	1147	359	435	1	538	0	0	0	
Future Volume (vph)	396	832	0	0	1147	359	435	1	538	0	0	0	
Ideal Flow (vphpl)	1900	1900	1900	1900	1900	1900	1900	1900	1900	1900	1900	1900	
Total Lost time (s)	4.0	4.0			4.0	4.0	4.0	4.0	4.0				
Lane Util. Factor	0.97	0.95			0.91	1.00	0.95	0.95	0.88				
Frbp, ped/bikes	1.00	1.00			1.00	0.99	1.00	1.00	0.79				
Flpb, ped/bikes	1.00	1.00			1.00	1.00	1.00	1.00	1.00				
Frt	1.00	1.00			1.00	0.85	1.00	1.00	0.85				
Flt Protected	0.95	1.00			1.00	1.00	0.95	0.95	1.00				
Satd. Flow (prot)	3502	3574			5136	1561	1618	1622	2219				
Flt Permitted	0.95	1.00			1.00	1.00	0.95	0.95	1.00				
Satd. Flow (perm)	3502	3574			5136	1561	1618	1622	2219				
Peak-hour factor, PHF	0.97	0.97	0.97	0.97	0.97	0.97	0.97	0.97	0.97	0.97	0.97	0.97	
Adj. Flow (vph)	408	858	0	0	1182	370	448	1	555	0	0	0	
RTOR Reduction (vph)	0	0	0	0	0	0	0	0	259	0	0	0	
Lane Group Flow (vph)	408	858	0	0	1182	370	224	225	296	0	0	0	
Confl. Peds. (#/hr)	1		1	1		1			28	28			
Confl. Bikes (#/hr)						1			2				
Heavy Vehicles (%)	0%	1%	0%	0%	1%	2%	6%	0%	1%	0%	0%	0%	
Turn Type	Prot	NA			NA	Perm	Split	NA	Perm				
Protected Phases	5	2			6		8	8					
Permitted Phases		2				6			8				
Actuated Green, G (s)	17.2	79.3			58.1	58.1	22.7	22.7	22.7				
Effective Green, g (s)	17.2	79.3			58.1	58.1	22.7	22.7	22.7				
Actuated g/C Ratio	0.16	0.72			0.53	0.53	0.21	0.21	0.21				
Clearance Time (s)	4.0	4.0			4.0	4.0	4.0	4.0	4.0				
Vehicle Extension (s)	2.3	5.2			5.2	5.2	3.0	3.0	3.0				
Lane Grp Cap (vph)	547	2576			2712	824	333	334	457				
v/s Ratio Prot	c0.12	0.24			0.23		0.14	c0.14					
v/s Ratio Perm						c0.24			0.13				
v/c Ratio	0.75	0.33			0.44	0.45	0.67	0.67	0.65				
Uniform Delay, d1	44.3	5.6			15.9	16.1	40.2	40.2	40.0				
Progression Factor	1.27	1.51			1.00	1.00	1.00	1.00	1.00				
Incremental Delay, d2	4.8	0.3			0.5	1.8	5.3	5.3	3.2				
Delay (s)	61.3	8.8			16.4	17.8	45.5	45.5	43.2				
Level of Service	E	A			B	B	D	D	D				
Approach Delay (s)		25.8			16.8			44.2			0.0		
Approach LOS		C			B			D			A		
Intersection Summary													
HCM 2000 Control Delay			26.9		HCM 2000 Level of Service				C				
HCM 2000 Volume to Capacity ratio			0.55										
Actuated Cycle Length (s)			110.0		Sum of lost time (s)				12.0				
Intersection Capacity Utilization			80.1%		ICU Level of Service				D				
Analysis Period (min)			15										
c	Critical Lane Group												

HCM 6th Signalized Intersection Summary
3: I-5 NB & Wilsonville Rd

Wilsonville Pacific Star Gas Station TIA
Existing PM Peak Hour

												
Movement	EBL	EBT	EBR	WBL	WBT	WBR	NBL	NBT	NBR	SBL	SBT	SBR
Lane Configurations	 	 			  				 			
Traffic Volume (veh/h)	396	832	0	0	1147	359	435	1	538	0	0	0
Future Volume (veh/h)	396	832	0	0	1147	359	435	1	538	0	0	0
Initial Q (Qb), veh	0	0	0	0	0	0	0	0	0			
Ped-Bike Adj(A_pbT)	1.00		1.00	1.00		1.00	1.00		0.90			
Parking Bus, Adj	1.00	1.00	1.00	1.00	1.00	1.00	1.00	1.00	1.00			
Work Zone On Approach		No			No			No				
Adj Sat Flow, veh/h/ln	1900	1885	0	0	1885	1870	1811	1900	1885			
Adj Flow Rate, veh/h	408	858	0	0	1182	0	449	0	288			
Peak Hour Factor	0.97	0.97	0.97	0.97	0.97	0.97	0.97	0.97	0.97			
Percent Heavy Veh, %	0	1	0	0	1	2	6	0	1			
Cap, veh/h	477	2697	0	0	2990		601	0	500			
Arrive On Green	0.27	1.00	0.00	0.00	0.58	0.00	0.17	0.00	0.17			
Sat Flow, veh/h	3510	3676	0	0	5316	1585	3450	0	2867			
Grp Volume(v), veh/h	408	858	0	0	1182	0	449	0	288			
Grp Sat Flow(s),veh/h/ln	1755	1791	0	0	1716	1585	1725	0	1434			
Q Serve(g_s), s	12.1	0.0	0.0	0.0	13.7	0.0	13.6	0.0	10.1			
Cycle Q Clear(g_c), s	12.1	0.0	0.0	0.0	13.7	0.0	13.6	0.0	10.1			
Prop In Lane	1.00		0.00	0.00		1.00	1.00		1.00			
Lane Grp Cap(c), veh/h	477	2697	0	0	2990		601	0	500			
V/C Ratio(X)	0.86	0.32	0.00	0.00	0.40		0.75	0.00	0.58			
Avail Cap(c_a), veh/h	670	2697	0	0	2990		1004	0	834			
HCM Platoon Ratio	2.00	2.00	1.00	1.00	1.00	1.00	1.00	1.00	1.00			
Upstream Filter(I)	0.93	0.93	0.00	0.00	1.00	0.00	1.00	0.00	1.00			
Uniform Delay (d), s/veh	39.0	0.0	0.0	0.0	12.5	0.0	43.1	0.0	41.7			
Incr Delay (d2), s/veh	6.1	0.3	0.0	0.0	0.4	0.0	1.9	0.0	1.1			
Initial Q Delay(d3),s/veh	0.0	0.0	0.0	0.0	0.0	0.0	0.0	0.0	0.0			
%ile BackOfQ(50%),veh/ln	4.8	0.1	0.0	0.0	5.1	0.0	5.9	0.0	3.6			
Unsig. Movement Delay, s/veh						17.80						
LnGrp Delay(d),s/veh	45.2	0.3	0.0	0.0	12.9	17.8	45.0	0.0	42.7			
LnGrp LOS	D	A	A	A	B	B	D	A	D			
Approach Vol, veh/h		1266			1552	A		737				
Approach Delay, s/veh		14.8			14.1			44.1				
Approach LOS		B			B			D				
Timer - Assigned Phs		2			5	6		8				
Phs Duration (G+Y+Rc), s		86.8			18.9	67.9		23.2				
Change Period (Y+Rc), s		4.0			4.0	4.0		4.0				
Max Green Setting (Gmax), s		70.0			21.0	45.0		32.0				
Max Q Clear Time (g_c+I1), s		2.0			14.1	15.7		15.6				
Green Ext Time (p_c), s		12.3			0.8	14.4		3.6				
Intersection Summary												
HCM 6th Ctrl Delay				20.6								
HCM 6th LOS				C								
Notes												
User approved volume balancing among the lanes for turning movement.												
User approved changes to right turn type.												
Unsignalized Delay for [WBR] is included in calculations of the approach delay and intersection delay.												

HCM Signalized Intersection Capacity Analysis
1: Boones Ferry Rd & Wilsonville Rd

Wilsonville Pacific Star Gas Station TIA
Existing + Project PM Peak Hour

Movement	EBL	EBT	EBR	WBL	WBT	WBR	NBL	NBT	NBR	SBL	SBT	SBR
Lane Configurations												
Traffic Volume (vph)	79	748	119	389	601	280	194	113	407	527	216	105
Future Volume (vph)	79	748	119	389	601	280	194	113	407	527	216	105
Ideal Flow (vphpl)	1900	1900	1900	1900	1900	1900	1900	1900	1900	1900	1900	1900
Lane Width	12	12	12	12	12	16	12	12	12	12	12	12
Total Lost time (s)	5.0	5.0	5.0	5.0	5.0	4.0	5.0	5.0	5.0	5.0	5.0	5.0
Lane Util. Factor	1.00	0.91	1.00	0.97	0.95	1.00	1.00	1.00	1.00	0.97	1.00	1.00
Frbp, ped/bikes	1.00	1.00	0.98	1.00	1.00	0.97	1.00	1.00	0.99	1.00	0.99	1.00
Flpb, ped/bikes	1.00	1.00	1.00	1.00	1.00	1.00	1.00	1.00	1.00	1.00	1.00	1.00
Frt	1.00	1.00	0.85	1.00	1.00	0.85	1.00	1.00	0.85	1.00	0.95	1.00
Flt Protected	0.95	1.00	1.00	0.95	1.00	1.00	0.95	1.00	1.00	0.95	1.00	1.00
Satd. Flow (prot)	1736	5085	1566	3467	3539	1605	1805	1863	1573	3400	1754	1754
Flt Permitted	0.95	1.00	1.00	0.95	1.00	1.00	0.95	1.00	1.00	0.95	1.00	1.00
Satd. Flow (perm)	1736	5085	1566	3467	3539	1605	1805	1863	1573	3400	1754	1754
Peak-hour factor, PHF	0.95	0.95	0.95	0.95	0.95	0.95	0.95	0.95	0.95	0.95	0.95	0.95
Adj. Flow (vph)	83	787	125	409	633	295	204	119	428	555	227	111
RTOR Reduction (vph)	0	0	0	0	0	0	0	0	0	0	17	0
Lane Group Flow (vph)	83	787	125	409	633	295	204	119	428	555	321	0
Confl. Peds. (#/hr)	2		6	6		2	5		1	1		5
Confl. Bikes (#/hr)			1			2			1			2
Heavy Vehicles (%)	4%	2%	1%	1%	2%	11%	0%	2%	2%	3%	2%	3%
Turn Type	Prot	NA	Perm	Prot	NA	Perm	Split	NA	pm+ov	Split	NA	
Protected Phases	5	2		1	6		8	8	1	4	4	
Permitted Phases			2			6			8			
Actuated Green, G (s)	10.5	29.8	29.8	19.5	38.8	38.8	17.2	17.2	36.7	23.5	23.5	
Effective Green, g (s)	10.5	29.8	29.8	19.5	38.8	39.8	17.2	17.2	36.7	23.5	23.5	
Actuated g/C Ratio	0.10	0.27	0.27	0.18	0.35	0.36	0.16	0.16	0.33	0.21	0.21	
Clearance Time (s)	5.0	5.0	5.0	5.0	5.0	5.0	5.0	5.0	5.0	5.0	5.0	
Vehicle Extension (s)	2.3	4.1	4.1	2.3	4.1	4.1	2.3	2.3	2.3	2.3	2.3	
Lane Grp Cap (vph)	165	1377	424	614	1248	580	282	291	596	726	374	
v/s Ratio Prot	0.05	c0.15		0.12	0.18		0.11	0.06	c0.13	0.16	c0.18	
v/s Ratio Perm			0.08			0.18			0.14			
v/c Ratio	0.50	0.57	0.29	0.67	0.51	0.51	0.72	0.41	0.72	0.76	0.86	
Uniform Delay, d1	47.3	34.6	31.8	42.2	28.1	27.5	44.1	41.8	32.1	40.6	41.7	
Progression Factor	1.00	1.00	1.00	1.01	0.86	0.85	1.00	1.00	1.00	1.00	1.00	
Incremental Delay, d2	1.4	1.7	1.8	2.2	1.4	3.0	8.0	0.5	3.7	4.5	17.2	
Delay (s)	48.7	36.3	33.5	44.7	25.5	26.2	52.2	42.4	35.8	45.1	58.8	
Level of Service	D	D	C	D	C	C	D	D	D	D	E	
Approach Delay (s)		37.0			31.5			41.3			50.3	
Approach LOS		D			C			D			D	
Intersection Summary												
HCM 2000 Control Delay			39.0				HCM 2000 Level of Service				D	
HCM 2000 Volume to Capacity ratio			0.75									
Actuated Cycle Length (s)			110.0				Sum of lost time (s)				20.0	
Intersection Capacity Utilization			77.4%				ICU Level of Service				D	
Analysis Period (min)			15									

c Critical Lane Group

HCM 6th Signalized Intersection Summary
 1: Boones Ferry Rd & Wilsonville Rd

Wilsonville Pacific Star Gas Station TIA
 Existing + Project PM Peak Hour

Movement	EBL	EBT	EBR	WBL	WBT	WBR	NBL	NBT	NBR	SBL	SBT	SBR
Lane Configurations												
Traffic Volume (veh/h)	79	748	119	389	601	280	194	113	407	527	216	105
Future Volume (veh/h)	79	748	119	389	601	280	194	113	407	527	216	105
Initial Q (Qb), veh	0	0	0	0	0	0	0	0	0	0	0	0
Ped-Bike Adj(A_pbT)	1.00		1.00	1.00		1.00	1.00		0.98	1.00		0.98
Parking Bus, Adj	1.00	1.00	1.00	1.00	1.00	1.00	1.00	1.00	1.00	1.00	1.00	1.00
Work Zone On Approach		No			No			No			No	
Adj Sat Flow, veh/h/ln	1841	1870	1885	1885	1870	1806	1900	1870	1870	1856	1870	1856
Adj Flow Rate, veh/h	83	787	0	409	633	0	204	119	428	555	227	93
Peak Hour Factor	0.95	0.95	0.95	0.95	0.95	0.95	0.95	0.95	0.95	0.95	0.95	0.95
Percent Heavy Veh, %	4	2	1	1	2	11	0	2	2	3	2	3
Cap, veh/h	105	1145		412	1005		479	495	599	723	264	108
Arrive On Green	0.06	0.22	0.00	0.08	0.19	0.00	0.26	0.26	0.26	0.21	0.21	0.21
Sat Flow, veh/h	1753	5106	1598	3483	3554	1531	1810	1870	1556	3428	1252	513
Grp Volume(v), veh/h	83	787	0	409	633	0	204	119	428	555	0	320
Grp Sat Flow(s),veh/h/ln	1753	1702	1598	1742	1777	1531	1810	1870	1556	1714	0	1765
Q Serve(g_s), s	5.1	15.5	0.0	12.9	18.0	0.0	10.3	5.5	25.8	16.8	0.0	19.2
Cycle Q Clear(g_c), s	5.1	15.5	0.0	12.9	18.0	0.0	10.3	5.5	25.8	16.8	0.0	19.2
Prop In Lane	1.00		1.00	1.00		1.00	1.00		1.00	1.00		0.29
Lane Grp Cap(c), veh/h	105	1145		412	1005		479	495	599	723	0	372
V/C Ratio(X)	0.79	0.69		0.99	0.63		0.43	0.24	0.71	0.77	0.00	0.86
Avail Cap(c_a), veh/h	112	1145		412	1005		526	544	640	841	0	433
HCM Platoon Ratio	1.00	1.00	1.00	0.67	0.67	0.67	1.00	1.00	1.00	1.00	1.00	1.00
Upstream Filter(I)	1.00	1.00	0.00	0.90	0.90	0.00	1.00	1.00	1.00	1.00	0.00	1.00
Uniform Delay (d), s/veh	51.0	39.1	0.0	50.6	39.3	0.0	33.5	31.8	28.9	40.9	0.0	41.8
Incr Delay (d2), s/veh	28.0	3.4	0.0	40.3	2.7	0.0	0.4	0.2	3.1	3.3	0.0	13.3
Initial Q Delay(d3),s/veh	0.0	0.0	0.0	0.0	0.0	0.0	0.0	0.0	0.0	0.0	0.0	0.0
%ile BackOfQ(50%),veh/ln	3.0	6.7	0.0	8.1	8.5	0.0	4.5	2.5	9.9	7.3	0.0	9.7
Unsig. Movement Delay, s/veh			36.10			26.80						
LnGrp Delay(d),s/veh	79.0	42.5	36.1	90.9	42.0	26.8	33.9	31.9	32.0	44.1	0.0	55.1
LnGrp LOS	E	D	D	F	D	C	C	C	C	D	A	E
Approach Vol, veh/h		995	A		1337	A		751				875
Approach Delay, s/veh		44.7			53.6			32.5				48.1
Approach LOS		D			D			C				D
Timer - Assigned Phs	1	2		4	5	6		8				
Phs Duration (G+Y+Rc), s	18.0	29.7		28.2	11.6	36.1		34.1				
Change Period (Y+Rc), s	5.0	5.0		5.0	5.0	5.0		5.0				
Max Green Setting (Gmax), s	13.0	18.0		27.0	7.0	24.0		32.0				
Max Q Clear Time (g_c+I1), s	14.9	17.5		21.2	7.1	20.0		27.8				
Green Ext Time (p_c), s	0.0	0.3		1.7	0.0	1.6		1.1				

Intersection Summary













HCM 6th Ctrl Delay	46.2
HCM 6th LOS	D

Notes

- User approved pedestrian interval to be less than phase max green.
- User approved changes to right turn type.
- Unsignalized Delay for [EBR, WBR] is included in calculations of the approach delay and intersection delay.













HCM Signalized Intersection Capacity Analysis
2: I-5 SB & Wilsonville Rd

Wilsonville Pacific Star Gas Station TIA
Existing + Project PM Peak Hour

												
Movement	EBL	EBT	EBR	WBL	WBT	WBR	NBL	NBT	NBR	SBL	SBT	SBR
Lane Configurations		↑↑↑	↑	↑↑	↑↑					↑	↑	↑↑
Traffic Volume (vph)	0	947	735	534	1058	0	0	0	0	302	1	312
Future Volume (vph)	0	947	735	534	1058	0	0	0	0	302	1	312
Ideal Flow (vphpl)	1900	1900	1900	1900	1900	1900	1900	1900	1900	1900	1900	1900
Total Lost time (s)		4.0	4.0	4.0	4.0					4.0	4.0	4.0
Lane Util. Factor		0.91	1.00	0.97	0.95					0.95	0.95	0.88
Frbp, ped/bikes		1.00	0.97	1.00	1.00					1.00	1.00	0.98
Flpb, ped/bikes		1.00	1.00	1.00	1.00					1.00	1.00	1.00
Frt		1.00	0.85	1.00	1.00					1.00	1.00	0.85
Flt Protected		1.00	1.00	0.95	1.00					0.95	0.95	1.00
Satd. Flow (prot)		5085	1543	3467	3505					1698	1703	2598
Flt Permitted		1.00	1.00	0.95	1.00					0.95	0.95	1.00
Satd. Flow (perm)		5085	1543	3467	3505					1698	1703	2598
Peak-hour factor, PHF	0.97	0.97	0.97	0.97	0.97	0.97	0.97	0.97	0.97	0.97	0.97	0.97
Adj. Flow (vph)	0	976	758	551	1091	0	0	0	0	311	1	322
RTOR Reduction (vph)	0	0	0	0	0	0	0	0	0	0	0	203
Lane Group Flow (vph)	0	976	758	551	1091	0	0	0	0	155	157	119
Confl. Peds. (#/hr)	7		8	8		7	1			3	3	1
Confl. Bikes (#/hr)						4						
Heavy Vehicles (%)	0%	2%	2%	1%	3%	0%	0%	0%	0%	1%	0%	7%
Turn Type		NA	Perm	Prot	NA					Split	NA	Perm
Protected Phases		2		1	6					4	4	
Permitted Phases			2		6							4
Actuated Green, G (s)		59.8	59.8	22.4	86.7					14.8	14.8	14.8
Effective Green, g (s)		59.8	59.8	22.9	86.7					15.3	15.3	15.3
Actuated g/C Ratio		0.54	0.54	0.21	0.79					0.14	0.14	0.14
Clearance Time (s)		4.0	4.0	4.5	4.0					4.5	4.5	4.5
Vehicle Extension (s)		5.2	5.2	2.3	5.2					2.3	2.3	2.3
Lane Grp Cap (vph)		2764	838	721	2762					236	236	361
v/s Ratio Prot		0.19		c0.16	0.31					0.09	c0.09	
v/s Ratio Perm			c0.49									0.05
v/c Ratio		0.35	0.90	0.76	0.40					0.66	0.67	0.33
Uniform Delay, d1		14.2	22.5	41.0	3.6					44.9	44.9	42.7
Progression Factor		1.19	1.22	1.20	0.97					1.00	1.00	1.00
Incremental Delay, d2		0.3	11.9	4.1	0.4					5.4	5.9	0.3
Delay (s)		17.1	39.4	53.3	3.9					50.3	50.8	43.0
Level of Service		B	D	D	A					D	D	D
Approach Delay (s)		26.9			20.5			0.0			46.7	
Approach LOS		C			C			A			D	
Intersection Summary												
HCM 2000 Control Delay			27.4			HCM 2000 Level of Service				C		
HCM 2000 Volume to Capacity ratio			0.83									
Actuated Cycle Length (s)			110.0			Sum of lost time (s)				12.0		
Intersection Capacity Utilization			80.4%			ICU Level of Service				D		
Analysis Period (min)			15									
c	Critical Lane Group											

HCM 6th Signalized Intersection Summary
2: I-5 SB & Wilsonville Rd



















Wilsonville Pacific Star Gas Station TIA
Existing + Project PM Peak Hour

												
Movement	EBL	EBT	EBR	WBL	WBT	WBR	NBL	NBT	NBR	SBL	SBT	SBR
Lane Configurations		↑↑↑	↗	↘↗	↑↑					↘	↗	↘↗
Traffic Volume (veh/h)	0	947	735	534	1058	0	0	0	0	302	1	312
Future Volume (veh/h)	0	947	735	534	1058	0	0	0	0	302	1	312
Initial Q (Qb), veh	0	0	0	0	0	0				0	0	0
Ped-Bike Adj(A_pbT)	1.00		1.00	1.00		1.00				1.00		0.99
Parking Bus, Adj	1.00	1.00	1.00	1.00	1.00	1.00				1.00	1.00	1.00
Work Zone On Approach		No			No						No	
Adj Sat Flow, veh/h/ln	0	1870	1870	1885	1856	0				1885	1900	1796
Adj Flow Rate, veh/h	0	976	0	551	1091	0				312	0	113
Peak Hour Factor	0.97	0.97	0.97	0.97	0.97	0.97				0.97	0.97	0.97
Percent Heavy Veh, %	0	2	2	1	3	0				1	0	7
Cap, veh/h	0	3068		583	2836	0				441	0	369
Arrive On Green	0.00	1.00	0.00	0.33	1.00	0.00				0.12	0.00	0.12
Sat Flow, veh/h	0	5274	1585	3483	3618	0				3591	0	3007
Grp Volume(v), veh/h	0	976	0	551	1091	0				312	0	113
Grp Sat Flow(s),veh/h/ln	0	1702	1585	1742	1763	0				1795	0	1504
Q Serve(g_s), s	0.0	0.0	0.0	16.9	0.0	0.0				9.2	0.0	3.8
Cycle Q Clear(g_c), s	0.0	0.0	0.0	16.9	0.0	0.0				9.2	0.0	3.8
Prop In Lane	0.00		1.00	1.00		0.00				1.00		1.00
Lane Grp Cap(c), veh/h	0	3068		583	2836	0				441	0	369
V/C Ratio(X)	0.00	0.32		0.95	0.38	0.00				0.71	0.00	0.31
Avail Cap(c_a), veh/h	0	3068		583	2836	0				832	0	697
HCM Platoon Ratio	1.00	2.00	2.00	2.00	2.00	1.00				1.00	1.00	1.00
Upstream Filter(I)	0.00	0.66	0.00	0.87	0.87	0.00				1.00	0.00	1.00
Uniform Delay (d), s/veh	0.0	0.0	0.0	36.1	0.0	0.0				46.3	0.0	44.0
Incr Delay (d2), s/veh	0.0	0.2	0.0	22.2	0.3	0.0				1.3	0.0	0.3
Initial Q Delay(d3),s/veh	0.0	0.0	0.0	0.0	0.0	0.0				0.0	0.0	0.0
%ile BackOfQ(50%),veh/ln	0.0	0.1	0.0	7.5	0.1	0.0				4.2	0.0	1.4
Unsig. Movement Delay, s/veh			44.50									
LnGrp Delay(d),s/veh	0.0	0.2	44.5	58.3	0.3	0.0				47.6	0.0	44.3
LnGrp LOS	A	A	D	E	A	A				D	A	D
Approach Vol, veh/h		1734	A		1642						425	
Approach Delay, s/veh		19.6			19.8						46.7	
Approach LOS		B			B						D	
Timer - Assigned Phs	1	2		4		6						
Phs Duration (G+Y+Rc), s	22.4	70.1		17.5		92.5						
Change Period (Y+Rc), s	4.5	4.0		4.5		4.0						
Max Green Setting (Gmax), s	17.9	54.1		25.0		76.5						
Max Q Clear Time (g_c+I1), s	18.9	2.0		11.2		2.0						
Green Ext Time (p_c), s	0.0	13.9		1.3		18.3						
Intersection Summary												
HCM 6th Ctrl Delay			22.7									
HCM 6th LOS			C									
Notes												
User approved pedestrian interval to be less than phase max green.												
User approved volume balancing among the lanes for turning movement.												
User approved changes to right turn type.												

Unsignalized Delay for [EBR] is included in calculations of the approach delay and intersection delay.

























HCM Signalized Intersection Capacity Analysis
3: I-5 NB & Wilsonville Rd

Wilsonville Pacific Star Gas Station TIA
Existing + Project PM Peak Hour

												
Movement	EBL	EBT	EBR	WBL	WBT	WBR	NBL	NBT	NBR	SBL	SBT	SBR
Lane Configurations												
Traffic Volume (vph)	412	837	0	0	1152	359	440	1	538	0	0	0
Future Volume (vph)	412	837	0	0	1152	359	440	1	538	0	0	0
Ideal Flow (vphpl)	1900	1900	1900	1900	1900	1900	1900	1900	1900	1900	1900	1900
Total Lost time (s)	4.0	4.0			4.0	4.0	4.0	4.0	4.0			
Lane Util. Factor	0.97	0.95			0.91	1.00	0.95	0.95	0.88			
Frpb, ped/bikes	1.00	1.00			1.00	0.99	1.00	1.00	0.79			
Flpb, ped/bikes	1.00	1.00			1.00	1.00	1.00	1.00	1.00			
Frt	1.00	1.00			1.00	0.85	1.00	1.00	0.85			
Flt Protected	0.95	1.00			1.00	1.00	0.95	0.95	1.00			
Satd. Flow (prot)	3502	3574			5136	1561	1618	1622	2219			
Flt Permitted	0.95	1.00			1.00	1.00	0.95	0.95	1.00			
Satd. Flow (perm)	3502	3574			5136	1561	1618	1622	2219			
Peak-hour factor, PHF	0.97	0.97	0.97	0.97	0.97	0.97	0.97	0.97	0.97	0.97	0.97	0.97
Adj. Flow (vph)	425	863	0	0	1188	370	454	1	555	0	0	0
RTOR Reduction (vph)	0	0	0	0	0	0	0	0	263	0	0	0
Lane Group Flow (vph)	425	863	0	0	1188	370	227	228	292	0	0	0
Confl. Peds. (#/hr)	1		1	1		1			28	28		
Confl. Bikes (#/hr)						1			2			
Heavy Vehicles (%)	0%	1%	0%	0%	1%	2%	6%	0%	1%	0%	0%	0%
Turn Type	Prot	NA			NA	Perm	Split	NA	Perm			
Protected Phases	5	2			6		8	8				
Permitted Phases		2				6			8			
Actuated Green, G (s)	17.8	79.3			57.5	57.5	22.7	22.7	22.7			
Effective Green, g (s)	17.8	79.3			57.5	57.5	22.7	22.7	22.7			
Actuated g/C Ratio	0.16	0.72			0.52	0.52	0.21	0.21	0.21			
Clearance Time (s)	4.0	4.0			4.0	4.0	4.0	4.0	4.0			
Vehicle Extension (s)	2.3	5.2			5.2	5.2	3.0	3.0	3.0			
Lane Grp Cap (vph)	566	2576			2684	815	333	334	457			
v/s Ratio Prot	c0.12	0.24			0.23		0.14	c0.14				
v/s Ratio Perm						c0.24			0.13			
v/c Ratio	0.75	0.34			0.44	0.45	0.68	0.68	0.64			
Uniform Delay, d1	44.0	5.6			16.3	16.4	40.3	40.3	39.9			
Progression Factor	1.30	1.40			1.00	1.00	1.00	1.00	1.00			
Incremental Delay, d2	4.9	0.3			0.5	1.8	5.7	5.7	2.9			
Delay (s)	62.0	8.2			16.8	18.2	46.0	46.0	42.8			
Level of Service	E	A			B	B	D	D	D			
Approach Delay (s)		26.0			17.2			44.3			0.0	
Approach LOS		C			B			D			A	
Intersection Summary												
HCM 2000 Control Delay			27.2		HCM 2000 Level of Service				C			
HCM 2000 Volume to Capacity ratio			0.56									
Actuated Cycle Length (s)			110.0		Sum of lost time (s)				12.0			
Intersection Capacity Utilization			80.4%		ICU Level of Service				D			
Analysis Period (min)			15									
c	Critical Lane Group											





























HCM 6th Signalized Intersection Summary
3: I-5 NB & Wilsonville Rd

Wilsonville Pacific Star Gas Station TIA
Existing + Project PM Peak Hour

												
Movement	EBL	EBT	EBR	WBL	WBT	WBR	NBL	NBT	NBR	SBL	SBT	SBR
Lane Configurations	 	 			  			 	 			
Traffic Volume (veh/h)	412	837	0	0	1152	359	440	1	538	0	0	0
Future Volume (veh/h)	412	837	0	0	1152	359	440	1	538	0	0	0
Initial Q (Qb), veh	0	0	0	0	0	0	0	0	0			
Ped-Bike Adj(A_pbT)	1.00		1.00	1.00		1.00	1.00		0.90			
Parking Bus, Adj	1.00	1.00	1.00	1.00	1.00	1.00	1.00	1.00	1.00			
Work Zone On Approach		No			No			No				
Adj Sat Flow, veh/h/ln	1900	1885	0	0	1885	1870	1811	1900	1885			
Adj Flow Rate, veh/h	425	863	0	0	1188	0	455	0	284			
Peak Hour Factor	0.97	0.97	0.97	0.97	0.97	0.97	0.97	0.97	0.97			
Percent Heavy Veh, %	0	1	0	0	1	2	6	0	1			
Cap, veh/h	495	2694	0	0	2959		604	0	502			
Arrive On Green	0.28	1.00	0.00	0.00	0.57	0.00	0.18	0.00	0.18			
Sat Flow, veh/h	3510	3676	0	0	5316	1585	3450	0	2869			
Grp Volume(v), veh/h	425	863	0	0	1188	0	455	0	284			
Grp Sat Flow(s),veh/h/ln	1755	1791	0	0	1716	1585	1725	0	1434			
Q Serve(g_s), s	12.6	0.0	0.0	0.0	14.0	0.0	13.8	0.0	10.0			
Cycle Q Clear(g_c), s	12.6	0.0	0.0	0.0	14.0	0.0	13.8	0.0	10.0			
Prop In Lane	1.00		0.00	0.00		1.00	1.00		1.00			
Lane Grp Cap(c), veh/h	495	2694	0	0	2959		604	0	502			
V/C Ratio(X)	0.86	0.32	0.00	0.00	0.40		0.75	0.00	0.57			
Avail Cap(c_a), veh/h	702	2694	0	0	2959		972	0	808			
HCM Platoon Ratio	2.00	2.00	1.00	1.00	1.00	1.00	1.00	1.00	1.00			
Upstream Filter(I)	0.92	0.92	0.00	0.00	1.00	0.00	1.00	0.00	1.00			
Uniform Delay (d), s/veh	38.5	0.0	0.0	0.0	12.9	0.0	43.1	0.0	41.5			
Incr Delay (d2), s/veh	5.9	0.3	0.0	0.0	0.4	0.0	1.9	0.0	1.0			
Initial Q Delay(d3),s/veh	0.0	0.0	0.0	0.0	0.0	0.0	0.0	0.0	0.0			
%ile BackOfQ(50%),veh/ln	5.0	0.1	0.0	0.0	5.2	0.0	6.0	0.0	3.6			
Unsig. Movement Delay, s/veh						18.20						
LnGrp Delay(d),s/veh	44.4	0.3	0.0	0.0	13.3	18.2	45.0	0.0	42.5			
LnGrp LOS	D	A	A	A	B	B	D	A	D			
Approach Vol, veh/h		1288			1558	A		739				
Approach Delay, s/veh		14.8			14.5			44.1				
Approach LOS		B			B			D				
Timer - Assigned Phs		2			5	6		8				
Phs Duration (G+Y+Rc), s		86.7			19.5	67.2		23.3				
Change Period (Y+Rc), s		4.0			4.0	4.0		4.0				
Max Green Setting (Gmax), s		71.0			22.0	45.0		31.0				
Max Q Clear Time (g_c+I1), s		2.0			14.6	16.0		15.8				
Green Ext Time (p_c), s		12.4			0.9	14.4		3.5				
Intersection Summary												
HCM 6th Ctrl Delay				20.7								
HCM 6th LOS				C								
Notes												
User approved volume balancing among the lanes for turning movement.												
User approved changes to right turn type.												
Unsignalized Delay for [WBR] is included in calculations of the approach delay and intersection delay.												

HCM Signalized Intersection Capacity Analysis
1: Boones Ferry Rd & Wilsonville Rd





























Wilsonville Pacific Star Gas Station TIA
Existing + Stage II PM Peak Hour

												
Movement	EBL	EBT	EBR	WBL	WBT	WBR	NBL	NBT	NBR	SBL	SBT	SBR
Lane Configurations		  		 	 					 		
Traffic Volume (vph)	36	854	129	398	680	235	209	112	412	480	217	67
Future Volume (vph)	36	854	129	398	680	235	209	112	412	480	217	67
Ideal Flow (vphpl)	1900	1900	1900	1900	1900	1900	1900	1900	1900	1900	1900	1900
Lane Width	12	12	12	12	12	16	12	12	12	12	12	12
Total Lost time (s)	5.0	5.0	5.0	5.0	5.0	4.0	5.0	5.0	5.0	5.0	5.0	5.0
Lane Util. Factor	1.00	0.91	1.00	0.97	0.95	1.00	1.00	1.00	1.00	0.97	1.00	1.00
Frbp, ped/bikes	1.00	1.00	0.98	1.00	1.00	0.97	1.00	1.00	0.99	1.00	1.00	1.00
Flpb, ped/bikes	1.00	1.00	1.00	1.00	1.00	1.00	1.00	1.00	1.00	1.00	1.00	1.00
Frt	1.00	1.00	0.85	1.00	1.00	0.85	1.00	1.00	0.85	1.00	0.96	1.00
Flt Protected	0.95	1.00	1.00	0.95	1.00	1.00	0.95	1.00	1.00	0.95	1.00	1.00
Satd. Flow (prot)	1736	5085	1566	3467	3539	1606	1805	1863	1573	3400	1784	1784
Flt Permitted	0.95	1.00	1.00	0.95	1.00	1.00	0.95	1.00	1.00	0.95	1.00	1.00
Satd. Flow (perm)	1736	5085	1566	3467	3539	1606	1805	1863	1573	3400	1784	1784
Peak-hour factor, PHF	0.95	0.95	0.95	0.95	0.95	0.95	0.95	0.95	0.95	0.95	0.95	0.95
Adj. Flow (vph)	38	899	136	419	716	247	220	118	434	505	228	71
RTOR Reduction (vph)	0	0	0	0	0	0	0	0	0	0	11	0
Lane Group Flow (vph)	38	899	136	419	716	247	220	118	434	505	288	0
Confl. Peds. (#/hr)	2		6	6		2	5		1	1		5
Confl. Bikes (#/hr)			1			2			1			2
Heavy Vehicles (%)	4%	2%	1%	1%	2%	11%	0%	2%	2%	3%	2%	3%
Turn Type	Prot	NA	Perm	Prot	NA	Perm	Split	NA	pm+ov	Split	NA	
Protected Phases	5	2		1	6		8	8	1	4	4	
Permitted Phases			2			6			8			
Actuated Green, G (s)	5.1	30.0	30.0	19.9	44.8	44.8	18.2	18.2	38.1	21.9	21.9	
Effective Green, g (s)	5.1	30.0	30.0	19.9	44.8	45.8	18.2	18.2	38.1	21.9	21.9	
Actuated g/C Ratio	0.05	0.27	0.27	0.18	0.41	0.42	0.17	0.17	0.35	0.20	0.20	
Clearance Time (s)	5.0	5.0	5.0	5.0	5.0	5.0	5.0	5.0	5.0	5.0	5.0	
Vehicle Extension (s)	2.3	4.1	4.1	2.3	4.1	4.1	2.3	2.3	2.3	2.3	2.3	
Lane Grp Cap (vph)	80	1386	427	627	1441	668	298	308	616	676	355	
v/s Ratio Prot	0.02	c0.18		0.12	0.20		0.12	0.06	c0.13	0.15	c0.16	
v/s Ratio Perm			0.09			0.15			0.15			
v/c Ratio	0.47	0.65	0.32	0.67	0.50	0.37	0.74	0.38	0.70	0.75	0.81	
Uniform Delay, d1	51.1	35.3	31.9	42.0	24.2	22.1	43.6	40.9	31.1	41.4	42.1	
Progression Factor	1.00	1.00	1.00	1.05	0.81	0.78	1.00	1.00	1.00	1.00	1.00	
Incremental Delay, d2	2.6	2.4	2.0	2.1	1.1	1.5	8.4	0.5	3.2	4.1	12.7	
Delay (s)	53.7	37.7	33.8	46.0	20.8	18.7	52.0	41.4	34.3	45.6	54.7	
Level of Service	D	D	C	D	C	B	D	D	C	D	D	
Approach Delay (s)		37.8			28.1			40.4			49.0	
Approach LOS		D			C			D			D	
Intersection Summary												
HCM 2000 Control Delay			37.2	HCM 2000 Level of Service				D				
HCM 2000 Volume to Capacity ratio			0.75									
Actuated Cycle Length (s)			110.0	Sum of lost time (s)				20.0				
Intersection Capacity Utilization			76.5%	ICU Level of Service				D				
Analysis Period (min)			15									

c Critical Lane Group

HCM 6th Signalized Intersection Summary
1: Boones Ferry Rd & Wilsonville Rd

Wilsonville Pacific Star Gas Station TIA
Existing + Stage II PM Peak Hour

												
Movement	EBL	EBT	EBR	WBL	WBT	WBR	NBL	NBT	NBR	SBL	SBT	SBR
Lane Configurations		  		 	 					 		
Traffic Volume (veh/h)	36	854	129	398	680	235	209	112	412	480	217	67
Future Volume (veh/h)	36	854	129	398	680	235	209	112	412	480	217	67
Initial Q (Qb), veh	0	0	0	0	0	0	0	0	0	0	0	0
Ped-Bike Adj(A_pbT)	1.00		1.00	1.00		1.00	1.00		0.98	1.00		0.98
Parking Bus, Adj	1.00	1.00	1.00	1.00	1.00	1.00	1.00	1.00	1.00	1.00	1.00	1.00
Work Zone On Approach		No			No			No			No	
Adj Sat Flow, veh/h/ln	1841	1870	1885	1885	1870	1806	1900	1870	1870	1856	1870	1856
Adj Flow Rate, veh/h	38	899	0	419	716	0	220	118	434	505	228	59
Peak Hour Factor	0.95	0.95	0.95	0.95	0.95	0.95	0.95	0.95	0.95	0.95	0.95	0.95
Percent Heavy Veh, %	4	2	1	1	2	11	0	2	2	3	2	3
Cap, veh/h	48	1224		412	1174		484	500	604	661	275	71
Arrive On Green	0.03	0.24	0.00	0.08	0.22	0.00	0.27	0.27	0.27	0.19	0.19	0.19
Sat Flow, veh/h	1753	5106	1598	3483	3554	1531	1810	1870	1556	3428	1425	369
Grp Volume(v), veh/h	38	899	0	419	716	0	220	118	434	505	0	287
Grp Sat Flow(s),veh/h/ln	1753	1702	1598	1742	1777	1531	1810	1870	1556	1714	0	1794
Q Serve(g_s), s	2.4	17.9	0.0	13.0	19.9	0.0	11.2	5.4	26.1	15.3	0.0	16.9
Cycle Q Clear(g_c), s	2.4	17.9	0.0	13.0	19.9	0.0	11.2	5.4	26.1	15.3	0.0	16.9
Prop In Lane	1.00		1.00	1.00		1.00	1.00		1.00	1.00		0.21
Lane Grp Cap(c), veh/h	48	1224		412	1174		484	500	604	661	0	346
V/C Ratio(X)	0.79	0.73		1.02	0.61		0.45	0.24	0.72	0.76	0.00	0.83
Avail Cap(c_a), veh/h	112	1224		412	1174		526	544	640	841	0	440
HCM Platoon Ratio	1.00	1.00	1.00	0.67	0.67	0.67	1.00	1.00	1.00	1.00	1.00	1.00
Upstream Filter(I)	1.00	1.00	0.00	0.89	0.89	0.00	1.00	1.00	1.00	1.00	0.00	1.00
Uniform Delay (d), s/veh	53.2	38.6	0.0	50.6	36.4	0.0	33.6	31.5	28.8	42.0	0.0	42.7
Incr Delay (d2), s/veh	16.1	3.9	0.0	46.4	2.1	0.0	0.4	0.1	3.3	2.6	0.0	9.0
Initial Q Delay(d3),s/veh	0.0	0.0	0.0	0.0	0.0	0.0	0.0	0.0	0.0	0.0	0.0	0.0
%ile BackOfQ(50%),veh/ln	1.2	7.8	0.0	8.5	9.3	0.0	4.9	2.5	10.1	6.7	0.0	8.3
Unsig. Movement Delay, s/veh			33.80			18.70						
LnGrp Delay(d),s/veh	69.3	42.5	33.8	97.1	38.5	18.7	34.0	31.6	32.1	44.7	0.0	51.6
LnGrp LOS	E	D	C	F	D	B	C	C	C	D	A	D
Approach Vol, veh/h		1073	A		1382	A		772			792	
Approach Delay, s/veh		42.4			52.7			32.5			47.2	
Approach LOS		D			D			C			D	
Timer - Assigned Phs	1	2		4	5	6		8				
Phs Duration (G+Y+Rc), s	18.0	31.4		26.2	8.0	41.4		34.4				
Change Period (Y+Rc), s	5.0	5.0		5.0	5.0	5.0		5.0				
Max Green Setting (Gmax), s	13.0	18.0		27.0	7.0	24.0		32.0				
Max Q Clear Time (g_c+I1), s	15.0	19.9		18.9	4.4	21.9		28.1				
Green Ext Time (p_c), s	0.0	0.0		1.8	0.0	1.0		1.1				

Intersection Summary













HCM 6th Ctrl Delay	45.0
HCM 6th LOS	D

Notes

- User approved pedestrian interval to be less than phase max green.
- User approved changes to right turn type.
- Unsignalized Delay for [EBR, WBR] is included in calculations of the approach delay and intersection delay.













HCM Signalized Intersection Capacity Analysis
2: I-5 SB & Wilsonville Rd

Wilsonville Pacific Star Gas Station TIA
Existing + Stage II PM Peak Hour

												
Movement	EBL	EBT	EBR	WBL	WBT	WBR	NBL	NBT	NBR	SBL	SBT	SBR
Lane Configurations		↑↑↑	↑	↑↑	↑↑					↑	↑	↑↑
Traffic Volume (vph)	0	982	764	537	1099	0	0	0	0	306	1	314
Future Volume (vph)	0	982	764	537	1099	0	0	0	0	306	1	314
Ideal Flow (vphpl)	1900	1900	1900	1900	1900	1900	1900	1900	1900	1900	1900	1900
Total Lost time (s)		4.0	4.0	4.0	4.0					4.0	4.0	4.0
Lane Util. Factor		0.91	1.00	0.97	0.95					0.95	0.95	0.88
Frbp, ped/bikes		1.00	0.97	1.00	1.00					1.00	1.00	0.98
Flpb, ped/bikes		1.00	1.00	1.00	1.00					1.00	1.00	1.00
Frt		1.00	0.85	1.00	1.00					1.00	1.00	0.85
Flt Protected		1.00	1.00	0.95	1.00					0.95	0.95	1.00
Satd. Flow (prot)		5085	1543	3467	3505					1698	1703	2598
Flt Permitted		1.00	1.00	0.95	1.00					0.95	0.95	1.00
Satd. Flow (perm)		5085	1543	3467	3505					1698	1703	2598
Peak-hour factor, PHF	0.97	0.97	0.97	0.97	0.97	0.97	0.97	0.97	0.97	0.97	0.97	0.97
Adj. Flow (vph)	0	1012	788	554	1133	0	0	0	0	315	1	324
RTOR Reduction (vph)	0	0	0	0	0	0	0	0	0	0	0	187
Lane Group Flow (vph)	0	1012	788	554	1133	0	0	0	0	157	159	137
Confl. Peds. (#/hr)	7		8	8		7	1			3	3	1
Confl. Bikes (#/hr)						4						
Heavy Vehicles (%)	0%	2%	2%	1%	3%	0%	0%	0%	0%	1%	0%	7%
Turn Type		NA	Perm	Prot	NA					Split	NA	Perm
Protected Phases		2		1	6					4	4	
Permitted Phases			2		6							4
Actuated Green, G (s)		59.0	59.0	23.1	86.6					14.9	14.9	14.9
Effective Green, g (s)		59.0	59.0	23.6	86.6					15.4	15.4	15.4
Actuated g/C Ratio		0.54	0.54	0.21	0.79					0.14	0.14	0.14
Clearance Time (s)		4.0	4.0	4.5	4.0					4.5	4.5	4.5
Vehicle Extension (s)		5.2	5.2	2.3	5.2					2.3	2.3	2.3
Lane Grp Cap (vph)		2727	827	743	2759					237	238	363
v/s Ratio Prot		0.20		c0.16	0.32					0.09	c0.09	
v/s Ratio Perm			c0.51									0.05
v/c Ratio		0.37	0.95	0.75	0.41					0.66	0.67	0.38
Uniform Delay, d1		14.8	24.2	40.4	3.7					44.8	44.9	43.0
Progression Factor		1.19	1.23	1.18	1.03					1.00	1.00	1.00
Incremental Delay, d2		0.3	17.6	3.4	0.4					5.8	5.9	0.4
Delay (s)		17.8	47.3	51.2	4.2					50.6	50.8	43.3
Level of Service		B	D	D	A					D	D	D
Approach Delay (s)		30.7			19.6			0.0			47.0	
Approach LOS		C			B			A			D	
Intersection Summary												
HCM 2000 Control Delay			28.7			HCM 2000 Level of Service				C		
HCM 2000 Volume to Capacity ratio			0.86									
Actuated Cycle Length (s)			110.0			Sum of lost time (s)				12.0		
Intersection Capacity Utilization			82.4%			ICU Level of Service				E		
Analysis Period (min)			15									
c	Critical Lane Group											

HCM 6th Signalized Intersection Summary
2: I-5 SB & Wilsonville Rd

























Wilsonville Pacific Star Gas Station TIA
Existing + Stage II PM Peak Hour

												
Movement	EBL	EBT	EBR	WBL	WBT	WBR	NBL	NBT	NBR	SBL	SBT	SBR
Lane Configurations		↑↑↑	↑	↑↑	↑↑					↑	↑	↑↑
Traffic Volume (veh/h)	0	982	764	537	1099	0	0	0	0	306	1	314
Future Volume (veh/h)	0	982	764	537	1099	0	0	0	0	306	1	314
Initial Q (Qb), veh	0	0	0	0	0	0				0	0	0
Ped-Bike Adj(A_pbT)	1.00		1.00	1.00		1.00				1.00		0.99
Parking Bus, Adj	1.00	1.00	1.00	1.00	1.00	1.00				1.00	1.00	1.00
Work Zone On Approach		No			No						No	
Adj Sat Flow, veh/h/ln	0	1870	1870	1885	1856	0				1885	1900	1796
Adj Flow Rate, veh/h	0	1012	0	554	1133	0				316	0	131
Peak Hour Factor	0.97	0.97	0.97	0.97	0.97	0.97				0.97	0.97	0.97
Percent Heavy Veh, %	0	2	2	1	3	0				1	0	7
Cap, veh/h	0	3092		560	2830	0				447	0	374
Arrive On Green	0.00	1.00	0.00	0.32	1.00	0.00				0.12	0.00	0.12
Sat Flow, veh/h	0	5274	1585	3483	3618	0				3591	0	3008
Grp Volume(v), veh/h	0	1012	0	554	1133	0				316	0	131
Grp Sat Flow(s),veh/h/ln	0	1702	1585	1742	1763	0				1795	0	1504
Q Serve(g_s), s	0.0	0.0	0.0	17.4	0.0	0.0				9.3	0.0	4.4
Cycle Q Clear(g_c), s	0.0	0.0	0.0	17.4	0.0	0.0				9.3	0.0	4.4
Prop In Lane	0.00		1.00	1.00		0.00				1.00		1.00
Lane Grp Cap(c), veh/h	0	3092		560	2830	0				447	0	374
V/C Ratio(X)	0.00	0.33		0.99	0.40	0.00				0.71	0.00	0.35
Avail Cap(c_a), veh/h	0	3092		560	2830	0				832	0	697
HCM Platoon Ratio	1.00	2.00	2.00	2.00	2.00	1.00				1.00	1.00	1.00
Upstream Filter(I)	0.00	0.64	0.00	0.86	0.86	0.00				1.00	0.00	1.00
Uniform Delay (d), s/veh	0.0	0.0	0.0	37.2	0.0	0.0				46.2	0.0	44.1
Incr Delay (d2), s/veh	0.0	0.2	0.0	32.2	0.4	0.0				1.3	0.0	0.3
Initial Q Delay(d3),s/veh	0.0	0.0	0.0	0.0	0.0	0.0				0.0	0.0	0.0
%ile BackOfQ(50%),veh/ln	0.0	0.1	0.0	8.4	0.1	0.0				4.2	0.0	1.7
Unsig. Movement Delay, s/veh			47.30									
LnGrp Delay(d),s/veh	0.0	0.2	47.3	69.4	0.4	0.0				47.5	0.0	44.4
LnGrp LOS	A	A	D	E	A	A				D	A	D
Approach Vol, veh/h		1800	A		1687						447	
Approach Delay, s/veh		20.8			23.0						46.6	
Approach LOS		C			C						D	
Timer - Assigned Phs	1	2		4		6						
Phs Duration (G+Y+Rc), s	21.7	70.6		17.7		92.3						
Change Period (Y+Rc), s	4.5	4.0		4.5		4.0						
Max Green Setting (Gmax), s	17.2	54.8		25.0		76.5						
Max Q Clear Time (g_c+I1), s	19.4	2.0		11.3		2.0						
Green Ext Time (p_c), s	0.0	14.7		1.3		19.5						
Intersection Summary												
HCM 6th Ctrl Delay			24.7									
HCM 6th LOS			C									
Notes												
User approved pedestrian interval to be less than phase max green.												
User approved volume balancing among the lanes for turning movement.												
User approved changes to right turn type.												

Unsignalized Delay for [EBR] is included in calculations of the approach delay and intersection delay.

























HCM Signalized Intersection Capacity Analysis
3: I-5 NB & Wilsonville Rd

Wilsonville Pacific Star Gas Station TIA
Existing + Stage II PM Peak Hour

												
Movement	EBL	EBT	EBR	WBL	WBT	WBR	NBL	NBT	NBR	SBL	SBT	SBR
Lane Configurations	 	 			  				 			
Traffic Volume (vph)	421	867	0	0	1167	362	469	1	542	0	0	0
Future Volume (vph)	421	867	0	0	1167	362	469	1	542	0	0	0
Ideal Flow (vphpl)	1900	1900	1900	1900	1900	1900	1900	1900	1900	1900	1900	1900
Total Lost time (s)	4.0	4.0			4.0	4.0	4.0	4.0	4.0			
Lane Util. Factor	0.97	0.95			0.91	1.00	0.95	0.95	0.88			
Frbp, ped/bikes	1.00	1.00			1.00	0.99	1.00	1.00	0.79			
Flpb, ped/bikes	1.00	1.00			1.00	1.00	1.00	1.00	1.00			
Frt	1.00	1.00			1.00	0.85	1.00	1.00	0.85			
Flt Protected	0.95	1.00			1.00	1.00	0.95	0.95	1.00			
Satd. Flow (prot)	3502	3574			5136	1561	1618	1622	2219			
Flt Permitted	0.95	1.00			1.00	1.00	0.95	0.95	1.00			
Satd. Flow (perm)	3502	3574			5136	1561	1618	1622	2219			
Peak-hour factor, PHF	0.97	0.97	0.97	0.97	0.97	0.97	0.97	0.97	0.97	0.97	0.97	0.97
Adj. Flow (vph)	434	894	0	0	1203	373	484	1	559	0	0	0
RTOR Reduction (vph)	0	0	0	0	0	0	0	0	243	0	0	0
Lane Group Flow (vph)	434	894	0	0	1203	373	242	243	316	0	0	0
Confl. Peds. (#/hr)	1		1	1		1			28	28		
Confl. Bikes (#/hr)						1			2			
Heavy Vehicles (%)	0%	1%	0%	0%	1%	2%	6%	0%	1%	0%	0%	0%
Turn Type	Prot	NA			NA	Perm	Split	NA	Perm			
Protected Phases	5	2			6		8	8				
Permitted Phases		2				6			8			
Actuated Green, G (s)	18.0	78.3			56.3	56.3	23.7	23.7	23.7			
Effective Green, g (s)	18.0	78.3			56.3	56.3	23.7	23.7	23.7			
Actuated g/C Ratio	0.16	0.71			0.51	0.51	0.22	0.22	0.22			
Clearance Time (s)	4.0	4.0			4.0	4.0	4.0	4.0	4.0			
Vehicle Extension (s)	2.3	5.2			5.2	5.2	3.0	3.0	3.0			
Lane Grp Cap (vph)	573	2544			2628	798	348	349	478			
v/s Ratio Prot	c0.12	0.25			0.23		0.15	c0.15				
v/s Ratio Perm						c0.24			0.14			
v/c Ratio	0.76	0.35			0.46	0.47	0.70	0.70	0.66			
Uniform Delay, d1	43.9	6.1			17.1	17.2	39.8	39.8	39.5			
Progression Factor	1.32	1.53			1.00	1.00	1.00	1.00	1.00			
Incremental Delay, d2	5.0	0.4			0.6	2.0	5.9	5.9	3.4			
Delay (s)	62.8	9.7			17.7	19.2	45.8	45.8	42.9			
Level of Service	E	A			B	B	D	D	D			
Approach Delay (s)		27.1			18.0			44.2			0.0	
Approach LOS		C			B			D			A	
Intersection Summary												
HCM 2000 Control Delay			28.0		HCM 2000 Level of Service				C			
HCM 2000 Volume to Capacity ratio			0.58									
Actuated Cycle Length (s)			110.0		Sum of lost time (s)				12.0			
Intersection Capacity Utilization			82.4%		ICU Level of Service				E			
Analysis Period (min)			15									
c	Critical Lane Group											

HCM 6th Signalized Intersection Summary
3: I-5 NB & Wilsonville Rd

Wilsonville Pacific Star Gas Station TIA
Existing + Stage II PM Peak Hour

												
Movement	EBL	EBT	EBR	WBL	WBT	WBR	NBL	NBT	NBR	SBL	SBT	SBR
Lane Configurations	 	 			  				 			
Traffic Volume (veh/h)	421	867	0	0	1167	362	469	1	542	0	0	0
Future Volume (veh/h)	421	867	0	0	1167	362	469	1	542	0	0	0
Initial Q (Qb), veh	0	0	0	0	0	0	0	0	0			
Ped-Bike Adj(A_pbT)	1.00		1.00	1.00		1.00	1.00		0.90			
Parking Bus, Adj	1.00	1.00	1.00	1.00	1.00	1.00	1.00	1.00	1.00			
Work Zone On Approach		No			No			No				
Adj Sat Flow, veh/h/ln	1900	1885	0	0	1885	1870	1811	1900	1885			
Adj Flow Rate, veh/h	434	894	0	0	1203	0	485	0	308			
Peak Hour Factor	0.97	0.97	0.97	0.97	0.97	0.97	0.97	0.97	0.97			
Percent Heavy Veh, %	0	1	0	0	1	2	6	0	1			
Cap, veh/h	503	2659	0	0	2896		638	0	533			
Arrive On Green	0.29	1.00	0.00	0.00	0.56	0.00	0.18	0.00	0.18			
Sat Flow, veh/h	3510	3676	0	0	5316	1585	3450	0	2882			
Grp Volume(v), veh/h	434	894	0	0	1203	0	485	0	308			
Grp Sat Flow(s),veh/h/ln	1755	1791	0	0	1716	1585	1725	0	1441			
Q Serve(g_s), s	12.9	0.0	0.0	0.0	14.7	0.0	14.7	0.0	10.7			
Cycle Q Clear(g_c), s	12.9	0.0	0.0	0.0	14.7	0.0	14.7	0.0	10.7			
Prop In Lane	1.00		0.00	0.00		1.00	1.00		1.00			
Lane Grp Cap(c), veh/h	503	2659	0	0	2896		638	0	533			
V/C Ratio(X)	0.86	0.34	0.00	0.00	0.42		0.76	0.00	0.58			
Avail Cap(c_a), veh/h	702	2659	0	0	2896		972	0	812			
HCM Platoon Ratio	2.00	2.00	1.00	1.00	1.00	1.00	1.00	1.00	1.00			
Upstream Filter(l)	0.92	0.92	0.00	0.00	1.00	0.00	1.00	0.00	1.00			
Uniform Delay (d), s/veh	38.2	0.0	0.0	0.0	13.7	0.0	42.5	0.0	40.9			
Incr Delay (d2), s/veh	6.3	0.3	0.0	0.0	0.4	0.0	1.9	0.0	1.0			
Initial Q Delay(d3),s/veh	0.0	0.0	0.0	0.0	0.0	0.0	0.0	0.0	0.0			
%ile BackOfQ(50%),veh/ln	5.1	0.1	0.0	0.0	5.5	0.0	6.4	0.0	3.9			
Unsig. Movement Delay, s/veh						19.20						
LnGrp Delay(d),s/veh	44.5	0.3	0.0	0.0	14.2	19.2	44.4	0.0	41.9			
LnGrp LOS	D	A	A	A	B	B	D	A	D			
Approach Vol, veh/h		1328			1576	A		793				
Approach Delay, s/veh		14.8			15.4			43.5				
Approach LOS		B			B			D				
Timer - Assigned Phs		2			5	6		8				
Phs Duration (G+Y+Rc), s		85.7			19.8	65.9		24.3				
Change Period (Y+Rc), s		4.0			4.0	4.0		4.0				
Max Green Setting (Gmax), s		71.0			22.0	45.0		31.0				
Max Q Clear Time (g_c+I1), s		2.0			14.9	16.7		16.7				
Green Ext Time (p_c), s		13.1			0.9	14.4		3.7				
Intersection Summary												
HCM 6th Ctrl Delay				21.2								
HCM 6th LOS				C								
Notes												
User approved volume balancing among the lanes for turning movement.												
User approved changes to right turn type.												
Unsignalized Delay for [WBR] is included in calculations of the approach delay and intersection delay.												

HCM Signalized Intersection Capacity Analysis
1: Boones Ferry Rd & Wilsonville Rd





























Wilsonville Pacific Star Gas Station TIA
Existing + Stage II + Project PM Peak Hour

Movement	EBL	EBT	EBR	WBL	WBT	WBR	NBL	NBT	NBR	SBL	SBT	SBR	
Lane Configurations													
Traffic Volume (vph)	84	817	129	398	650	291	209	115	412	543	220	108	
Future Volume (vph)	84	817	129	398	650	291	209	115	412	543	220	108	
Ideal Flow (vphpl)	1900	1900	1900	1900	1900	1900	1900	1900	1900	1900	1900	1900	
Lane Width	12	12	12	12	12	16	12	12	12	12	12	12	
Total Lost time (s)	5.0	5.0	5.0	5.0	5.0	4.0	5.0	5.0	5.0	5.0	5.0	5.0	
Lane Util. Factor	1.00	0.91	1.00	0.97	0.95	1.00	1.00	1.00	1.00	0.97	1.00	1.00	
Frbp, ped/bikes	1.00	1.00	0.98	1.00	1.00	0.97	1.00	1.00	0.99	1.00	0.99	1.00	
Flpb, ped/bikes	1.00	1.00	1.00	1.00	1.00	1.00	1.00	1.00	1.00	1.00	1.00	1.00	
Frt	1.00	1.00	0.85	1.00	1.00	0.85	1.00	1.00	0.85	1.00	0.95	1.00	
Flt Protected	0.95	1.00	1.00	0.95	1.00	1.00	0.95	1.00	1.00	0.95	1.00	1.00	
Satd. Flow (prot)	1736	5085	1566	3467	3539	1605	1805	1863	1573	3400	1754	1754	
Flt Permitted	0.95	1.00	1.00	0.95	1.00	1.00	0.95	1.00	1.00	0.95	1.00	1.00	
Satd. Flow (perm)	1736	5085	1566	3467	3539	1605	1805	1863	1573	3400	1754	1754	
Peak-hour factor, PHF	0.95	0.95	0.95	0.95	0.95	0.95	0.95	0.95	0.95	0.95	0.95	0.95	
Adj. Flow (vph)	88	860	136	419	684	306	220	121	434	572	232	114	
RTOR Reduction (vph)	0	0	0	0	0	0	0	0	0	0	16	0	
Lane Group Flow (vph)	88	860	136	419	684	306	220	121	434	572	330	0	
Confl. Peds. (#/hr)	2		6	6		2	5		1	1		5	
Confl. Bikes (#/hr)			1			2			1			2	
Heavy Vehicles (%)	4%	2%	1%	1%	2%	11%	0%	2%	2%	3%	2%	3%	
Turn Type	Prot	NA	Perm	Prot	NA	Perm	Split	NA	pm+ov	Split	NA	NA	
Protected Phases	5	2		1	6		8	8	1	4	4		
Permitted Phases			2			6			8				
Actuated Green, G (s)	11.0	28.0	28.0	19.9	36.9	36.9	18.2	18.2	38.1	23.9	23.9	23.9	
Effective Green, g (s)	11.0	28.0	28.0	19.9	36.9	37.9	18.2	18.2	38.1	23.9	23.9	23.9	
Actuated g/C Ratio	0.10	0.25	0.25	0.18	0.34	0.34	0.17	0.17	0.35	0.22	0.22	0.22	
Clearance Time (s)	5.0	5.0	5.0	5.0	5.0	5.0	5.0	5.0	5.0	5.0	5.0	5.0	
Vehicle Extension (s)	2.3	4.1	4.1	2.3	4.1	4.1	2.3	2.3	2.3	2.3	2.3	2.3	
Lane Grp Cap (vph)	173	1294	398	627	1187	552	298	308	616	738	381	381	
v/s Ratio Prot	0.05	c0.17		0.12	0.19		0.12	0.06	c0.13	0.17	c0.19		
v/s Ratio Perm			0.09			0.19			0.15				
v/c Ratio	0.51	0.66	0.34	0.67	0.58	0.55	0.74	0.39	0.70	0.78	0.86	0.86	
Uniform Delay, d1	46.9	36.8	33.5	42.0	30.1	29.2	43.6	41.0	31.1	40.5	41.5	41.5	
Progression Factor	1.00	1.00	1.00	1.03	0.88	0.86	1.00	1.00	1.00	1.00	1.00	1.00	
Incremental Delay, d2	1.4	2.7	2.3	2.1	1.9	3.7	8.4	0.5	3.2	4.8	17.8	17.8	
Delay (s)	48.3	39.5	35.8	45.4	28.2	28.9	52.0	41.5	34.3	45.3	59.3	59.3	
Level of Service	D	D	D	D	C	C	D	D	C	D	E	E	
Approach Delay (s)		39.7			33.5			40.5			50.6		
Approach LOS		D			C			D			D		
Intersection Summary													
HCM 2000 Control Delay			40.1		HCM 2000 Level of Service				D				
HCM 2000 Volume to Capacity ratio			0.77										
Actuated Cycle Length (s)			110.0		Sum of lost time (s)				20.0				
Intersection Capacity Utilization			78.8%		ICU Level of Service				D				
Analysis Period (min)			15										

c Critical Lane Group

HCM 6th Signalized Intersection Summary
 1: Boones Ferry Rd & Wilsonville Rd

Wilsonville Pacific Star Gas Station TIA
 Existing + Stage II + Project PM Peak Hour

												
Movement	EBL	EBT	EBR	WBL	WBT	WBR	NBL	NBT	NBR	SBL	SBT	SBR
Lane Configurations		  		 	 					 		
Traffic Volume (veh/h)	84	817	129	398	650	291	209	115	412	543	220	108
Future Volume (veh/h)	84	817	129	398	650	291	209	115	412	543	220	108
Initial Q (Qb), veh	0	0	0	0	0	0	0	0	0	0	0	0
Ped-Bike Adj(A_pbT)	1.00		1.00	1.00		1.00	1.00		0.98	1.00		0.98
Parking Bus, Adj	1.00	1.00	1.00	1.00	1.00	1.00	1.00	1.00	1.00	1.00	1.00	1.00
Work Zone On Approach		No			No			No			No	
Adj Sat Flow, veh/h/ln	1841	1870	1885	1885	1870	1806	1900	1870	1870	1856	1870	1856
Adj Flow Rate, veh/h	88	860	0	419	684	0	220	121	434	572	232	97
Peak Hour Factor	0.95	0.95	0.95	0.95	0.95	0.95	0.95	0.95	0.95	0.95	0.95	0.95
Percent Heavy Veh, %	4	2	1	1	2	11	0	2	2	3	2	3
Cap, veh/h	111	1109		412	967		484	500	604	738	268	112
Arrive On Green	0.06	0.22	0.00	0.08	0.18	0.00	0.27	0.27	0.27	0.22	0.22	0.22
Sat Flow, veh/h	1753	5106	1598	3483	3554	1531	1810	1870	1556	3428	1244	520
Grp Volume(v), veh/h	88	860	0	419	684	0	220	121	434	572	0	329
Grp Sat Flow(s),veh/h/ln	1753	1702	1598	1742	1777	1531	1810	1870	1556	1714	0	1764
Q Serve(g_s), s	5.4	17.4	0.0	13.0	19.9	0.0	11.2	5.6	26.1	17.3	0.0	19.8
Cycle Q Clear(g_c), s	5.4	17.4	0.0	13.0	19.9	0.0	11.2	5.6	26.1	17.3	0.0	19.8
Prop In Lane	1.00		1.00	1.00		1.00	1.00		1.00	1.00		0.29
Lane Grp Cap(c), veh/h	111	1109		412	967		484	500	604	738	0	380
V/C Ratio(X)	0.80	0.78		1.02	0.71		0.45	0.24	0.72	0.77	0.00	0.87
Avail Cap(c_a), veh/h	112	1109		412	967		526	544	640	841	0	433
HCM Platoon Ratio	1.00	1.00	1.00	0.67	0.67	0.67	1.00	1.00	1.00	1.00	1.00	1.00
Upstream Filter(l)	1.00	1.00	0.00	0.89	0.89	0.00	1.00	1.00	1.00	1.00	0.00	1.00
Uniform Delay (d), s/veh	50.8	40.5	0.0	50.6	40.9	0.0	33.6	31.5	28.8	40.6	0.0	41.6
Incr Delay (d2), s/veh	30.2	5.3	0.0	46.4	3.9	0.0	0.4	0.2	3.3	3.6	0.0	14.5
Initial Q Delay(d3),s/veh	0.0	0.0	0.0	0.0	0.0	0.0	0.0	0.0	0.0	0.0	0.0	0.0
%ile BackOfQ(50%),veh/ln	3.3	7.7	0.0	8.5	9.5	0.0	4.9	2.5	10.1	7.6	0.0	10.1
Unsig. Movement Delay, s/veh			35.80			28.90						
LnGrp Delay(d),s/veh	81.0	45.9	35.8	97.1	44.7	28.9	34.0	31.7	32.1	44.2	0.0	56.1
LnGrp LOS	F	D	D	F	D	C	C	C	C	D	A	E
Approach Vol, veh/h		1084	A		1409	A		775			901	
Approach Delay, s/veh		47.5			56.9			32.6			48.6	
Approach LOS		D			E			C			D	
Timer - Assigned Phs	1	2		4	5	6		8				
Phs Duration (G+Y+Rc), s	18.0	28.9		28.7	11.9	34.9		34.4				
Change Period (Y+Rc), s	5.0	5.0		5.0	5.0	5.0		5.0				
Max Green Setting (Gmax), s	13.0	18.0		27.0	7.0	24.0		32.0				
Max Q Clear Time (g_c+I1), s	15.0	19.4		21.8	7.4	21.9		28.1				
Green Ext Time (p_c), s	0.0	0.0		1.6	0.0	1.0		1.1				

Intersection Summary













HCM 6th Ctrl Delay	48.1
HCM 6th LOS	D

Notes

- User approved pedestrian interval to be less than phase max green.
- User approved changes to right turn type.
- Unsignalized Delay for [EBR, WBR] is included in calculations of the approach delay and intersection delay.

HCM Signalized Intersection Capacity Analysis
2: I-5 SB & Wilsonville Rd

Wilsonville Pacific Star Gas Station TIA
Existing + Stage II + Project PM Peak Hour

												
Movement	EBL	EBT	EBR	WBL	WBT	WBR	NBL	NBT	NBR	SBL	SBT	SBR
Lane Configurations		↑↑↑	↑	↑↑	↑↑					↑	↑	↑↑
Traffic Volume (vph)	0	1003	769	537	1109	0	0	0	0	306	1	330
Future Volume (vph)	0	1003	769	537	1109	0	0	0	0	306	1	330
Ideal Flow (vphpl)	1900	1900	1900	1900	1900	1900	1900	1900	1900	1900	1900	1900
Total Lost time (s)		4.0	4.0	4.0	4.0					4.0	4.0	4.0
Lane Util. Factor		0.91	1.00	0.97	0.95					0.95	0.95	0.88
Frbp, ped/bikes		1.00	0.97	1.00	1.00					1.00	1.00	0.98
Flpb, ped/bikes		1.00	1.00	1.00	1.00					1.00	1.00	1.00
Frt		1.00	0.85	1.00	1.00					1.00	1.00	0.85
Flt Protected		1.00	1.00	0.95	1.00					0.95	0.95	1.00
Satd. Flow (prot)		5085	1543	3467	3505					1698	1703	2598
Flt Permitted		1.00	1.00	0.95	1.00					0.95	0.95	1.00
Satd. Flow (perm)		5085	1543	3467	3505					1698	1703	2598
Peak-hour factor, PHF	0.97	0.97	0.97	0.97	0.97	0.97	0.97	0.97	0.97	0.97	0.97	0.97
Adj. Flow (vph)	0	1034	793	554	1143	0	0	0	0	315	1	340
RTOR Reduction (vph)	0	0	0	0	0	0	0	0	0	0	0	183
Lane Group Flow (vph)	0	1034	793	554	1143	0	0	0	0	157	159	157
Confl. Peds. (#/hr)	7		8	8		7	1			3	3	1
Confl. Bikes (#/hr)						4						
Heavy Vehicles (%)	0%	2%	2%	1%	3%	0%	0%	0%	0%	1%	0%	7%
Turn Type		NA	Perm	Prot	NA					Split	NA	Perm
Protected Phases		2		1	6					4	4	
Permitted Phases			2		6							4
Actuated Green, G (s)		59.0	59.0	23.1	86.6					14.9	14.9	14.9
Effective Green, g (s)		59.0	59.0	23.6	86.6					15.4	15.4	15.4
Actuated g/C Ratio		0.54	0.54	0.21	0.79					0.14	0.14	0.14
Clearance Time (s)		4.0	4.0	4.5	4.0					4.5	4.5	4.5
Vehicle Extension (s)		5.2	5.2	2.3	5.2					2.3	2.3	2.3
Lane Grp Cap (vph)		2727	827	743	2759					237	238	363
v/s Ratio Prot		0.20		c0.16	0.33					0.09	c0.09	
v/s Ratio Perm			c0.51									0.06
v/c Ratio		0.38	0.96	0.75	0.41					0.66	0.67	0.43
Uniform Delay, d1		14.8	24.3	40.4	3.7					44.8	44.9	43.3
Progression Factor		1.25	1.27	1.19	1.03					1.00	1.00	1.00
Incremental Delay, d2		0.3	18.0	3.3	0.4					5.8	5.9	0.5
Delay (s)		18.9	48.8	51.3	4.2					50.6	50.8	43.8
Level of Service		B	D	D	A					D	D	D
Approach Delay (s)		31.9			19.6			0.0			47.1	
Approach LOS		C			B			A			D	
Intersection Summary												
HCM 2000 Control Delay			29.3			HCM 2000 Level of Service				C		
HCM 2000 Volume to Capacity ratio			0.86									
Actuated Cycle Length (s)			110.0			Sum of lost time (s)				12.0		
Intersection Capacity Utilization			82.7%			ICU Level of Service				E		
Analysis Period (min)			15									
c	Critical Lane Group											

HCM 6th Signalized Intersection Summary
2: I-5 SB & Wilsonville Rd

Wilsonville Pacific Star Gas Station TIA
Existing + Stage II + Project PM Peak Hour



Movement	EBL	EBT	EBR	WBL	WBT	WBR	NBL	NBT	NBR	SBL	SBT	SBR
Lane Configurations		↑↑↑	↗	↘↗	↑↑					↘	↗	↘↗
Traffic Volume (veh/h)	0	1003	769	537	1109	0	0	0	0	306	1	330
Future Volume (veh/h)	0	1003	769	537	1109	0	0	0	0	306	1	330
Initial Q (Qb), veh	0	0	0	0	0	0				0	0	0
Ped-Bike Adj(A_pbT)	1.00		1.00	1.00		1.00				1.00		0.99
Parking Bus, Adj	1.00	1.00	1.00	1.00	1.00	1.00				1.00	1.00	1.00
Work Zone On Approach		No			No						No	
Adj Sat Flow, veh/h/ln	0	1870	1870	1885	1856	0				1885	1900	1796
Adj Flow Rate, veh/h	0	1034	0	554	1143	0				316	0	151
Peak Hour Factor	0.97	0.97	0.97	0.97	0.97	0.97				0.97	0.97	0.97
Percent Heavy Veh, %	0	2	2	1	3	0				1	0	7
Cap, veh/h	0	3089		560	2828	0				449	0	376
Arrive On Green	0.00	1.00	0.00	0.32	1.00	0.00				0.13	0.00	0.13
Sat Flow, veh/h	0	5274	1585	3483	3618	0				3591	0	3008
Grp Volume(v), veh/h	0	1034	0	554	1143	0				316	0	151
Grp Sat Flow(s),veh/h/ln	0	1702	1585	1742	1763	0				1795	0	1504
Q Serve(g_s), s	0.0	0.0	0.0	17.4	0.0	0.0				9.3	0.0	5.1
Cycle Q Clear(g_c), s	0.0	0.0	0.0	17.4	0.0	0.0				9.3	0.0	5.1
Prop In Lane	0.00		1.00	1.00		0.00				1.00		1.00
Lane Grp Cap(c), veh/h	0	3089		560	2828	0				449	0	376
V/C Ratio(X)	0.00	0.33		0.99	0.40	0.00				0.70	0.00	0.40
Avail Cap(c_a), veh/h	0	3089		560	2828	0				832	0	697
HCM Platoon Ratio	1.00	2.00	2.00	2.00	2.00	1.00				1.00	1.00	1.00
Upstream Filter(I)	0.00	0.61	0.00	0.86	0.86	0.00				1.00	0.00	1.00
Uniform Delay (d), s/veh	0.0	0.0	0.0	37.2	0.0	0.0				46.2	0.0	44.3
Incr Delay (d2), s/veh	0.0	0.2	0.0	32.2	0.4	0.0				1.2	0.0	0.4
Initial Q Delay(d3),s/veh	0.0	0.0	0.0	0.0	0.0	0.0				0.0	0.0	0.0
%ile BackOfQ(50%),veh/ln	0.0	0.1	0.0	8.4	0.1	0.0				4.2	0.0	1.9
Unsig. Movement Delay, s/veh			48.80									
LnGrp Delay(d),s/veh	0.0	0.2	48.8	69.4	0.4	0.0				47.4	0.0	44.8
LnGrp LOS	A	A	D	E	A	A				D	A	D
Approach Vol, veh/h		1827	A		1697						467	
Approach Delay, s/veh		21.3			22.9						46.6	
Approach LOS		C			C						D	
Timer - Assigned Phs	1	2		4		6						
Phs Duration (G+Y+Rc), s	21.7	70.5		17.8		92.2						
Change Period (Y+Rc), s	4.5	4.0		4.5		4.0						
Max Green Setting (Gmax), s	17.2	54.8		25.0		76.5						
Max Q Clear Time (g_c+I1), s	19.4	2.0		11.3		2.0						
Green Ext Time (p_c), s	0.0	15.1		1.4		19.8						

Intersection Summary

HCM 6th Ctrl Delay	24.9
HCM 6th LOS	C

























Notes

- User approved pedestrian interval to be less than phase max green.
- User approved volume balancing among the lanes for turning movement.
- User approved changes to right turn type.

Unsignalized Delay for [EBR] is included in calculations of the approach delay and intersection delay.

























HCM Signalized Intersection Capacity Analysis
3: I-5 NB & Wilsonville Rd

Wilsonville Pacific Star Gas Station TIA
Existing + Stage II + Project PM Peak Hour

												
Movement	EBL	EBT	EBR	WBL	WBT	WBR	NBL	NBT	NBR	SBL	SBT	SBR
Lane Configurations	 	 			  				 			
Traffic Volume (vph)	437	872	0	0	1172	362	474	1	542	0	0	0
Future Volume (vph)	437	872	0	0	1172	362	474	1	542	0	0	0
Ideal Flow (vphpl)	1900	1900	1900	1900	1900	1900	1900	1900	1900	1900	1900	1900
Total Lost time (s)	4.0	4.0			4.0	4.0	4.0	4.0	4.0			
Lane Util. Factor	0.97	0.95			0.91	1.00	0.95	0.95	0.88			
Frpb, ped/bikes	1.00	1.00			1.00	0.99	1.00	1.00	0.79			
Flpb, ped/bikes	1.00	1.00			1.00	1.00	1.00	1.00	1.00			
Frt	1.00	1.00			1.00	0.85	1.00	1.00	0.85			
Flt Protected	0.95	1.00			1.00	1.00	0.95	0.95	1.00			
Satd. Flow (prot)	3502	3574			5136	1561	1618	1622	2219			
Flt Permitted	0.95	1.00			1.00	1.00	0.95	0.95	1.00			
Satd. Flow (perm)	3502	3574			5136	1561	1618	1622	2219			
Peak-hour factor, PHF	0.97	0.97	0.97	0.97	0.97	0.97	0.97	0.97	0.97	0.97	0.97	0.97
Adj. Flow (vph)	451	899	0	0	1208	373	489	1	559	0	0	0
RTOR Reduction (vph)	0	0	0	0	0	0	0	0	241	0	0	0
Lane Group Flow (vph)	451	899	0	0	1208	373	244	246	318	0	0	0
Confl. Peds. (#/hr)	1		1	1		1			28	28		
Confl. Bikes (#/hr)						1			2			
Heavy Vehicles (%)	0%	1%	0%	0%	1%	2%	6%	0%	1%	0%	0%	0%
Turn Type	Prot	NA			NA	Perm	Split	NA	Perm			
Protected Phases	5	2			6		8	8				
Permitted Phases		2				6			8			
Actuated Green, G (s)	18.4	78.2			55.8	55.8	23.8	23.8	23.8			
Effective Green, g (s)	18.4	78.2			55.8	55.8	23.8	23.8	23.8			
Actuated g/C Ratio	0.17	0.71			0.51	0.51	0.22	0.22	0.22			
Clearance Time (s)	4.0	4.0			4.0	4.0	4.0	4.0	4.0			
Vehicle Extension (s)	2.3	5.2			5.2	5.2	3.0	3.0	3.0			
Lane Grp Cap (vph)	585	2540			2605	791	350	350	480			
v/s Ratio Prot	c0.13	0.25			0.24		0.15	c0.15				
v/s Ratio Perm						c0.24			0.14			
v/c Ratio	0.77	0.35			0.46	0.47	0.70	0.70	0.66			
Uniform Delay, d1	43.8	6.1			17.5	17.6	39.8	39.8	39.4			
Progression Factor	1.34	1.41			1.00	1.00	1.00	1.00	1.00			
Incremental Delay, d2	5.5	0.4			0.6	2.0	5.9	6.3	3.4			
Delay (s)	64.3	9.1			18.1	19.6	45.7	46.1	42.9			
Level of Service	E	A			B	B	D	D	D			
Approach Delay (s)		27.5			18.4			44.3			0.0	
Approach LOS		C			B			D			A	
Intersection Summary												
HCM 2000 Control Delay			28.3		HCM 2000 Level of Service				C			
HCM 2000 Volume to Capacity ratio			0.58									
Actuated Cycle Length (s)			110.0		Sum of lost time (s)				12.0			
Intersection Capacity Utilization			82.7%		ICU Level of Service				E			
Analysis Period (min)			15									
c	Critical Lane Group											

HCM 6th Signalized Intersection Summary
3: I-5 NB & Wilsonville Rd

Wilsonville Pacific Star Gas Station TIA
Existing + Stage II + Project PM Peak Hour

												
Movement	EBL	EBT	EBR	WBL	WBT	WBR	NBL	NBT	NBR	SBL	SBT	SBR
Lane Configurations	 	 			  				 			
Traffic Volume (veh/h)	437	872	0	0	1172	362	474	1	542	0	0	0
Future Volume (veh/h)	437	872	0	0	1172	362	474	1	542	0	0	0
Initial Q (Qb), veh	0	0	0	0	0	0	0	0	0			
Ped-Bike Adj(A_pbT)	1.00		1.00	1.00		1.00	1.00		0.90			
Parking Bus, Adj	1.00	1.00	1.00	1.00	1.00	1.00	1.00	1.00	1.00			
Work Zone On Approach		No			No			No				
Adj Sat Flow, veh/h/ln	1900	1885	0	0	1885	1870	1811	1900	1885			
Adj Flow Rate, veh/h	451	899	0	0	1208	0	490	0	311			
Peak Hour Factor	0.97	0.97	0.97	0.97	0.97	0.97	0.97	0.97	0.97			
Percent Heavy Veh, %	0	1	0	0	1	2	6	0	1			
Cap, veh/h	519	2654	0	0	2865		643	0	538			
Arrive On Green	0.30	1.00	0.00	0.00	0.56	0.00	0.19	0.00	0.19			
Sat Flow, veh/h	3510	3676	0	0	5316	1585	3450	0	2884			
Grp Volume(v), veh/h	451	899	0	0	1208	0	490	0	311			
Grp Sat Flow(s),veh/h/ln	1755	1791	0	0	1716	1585	1725	0	1442			
Q Serve(g_s), s	13.4	0.0	0.0	0.0	15.0	0.0	14.8	0.0	10.8			
Cycle Q Clear(g_c), s	13.4	0.0	0.0	0.0	15.0	0.0	14.8	0.0	10.8			
Prop In Lane	1.00		0.00	0.00		1.00	1.00		1.00			
Lane Grp Cap(c), veh/h	519	2654	0	0	2865		643	0	538			
V/C Ratio(X)	0.87	0.34	0.00	0.00	0.42		0.76	0.00	0.58			
Avail Cap(c_a), veh/h	702	2654	0	0	2865		972	0	813			
HCM Platoon Ratio	2.00	2.00	1.00	1.00	1.00	1.00	1.00	1.00	1.00			
Upstream Filter(I)	0.91	0.91	0.00	0.00	1.00	0.00	1.00	0.00	1.00			
Uniform Delay (d), s/veh	37.7	0.0	0.0	0.0	14.1	0.0	42.4	0.0	40.8			
Incr Delay (d2), s/veh	7.1	0.3	0.0	0.0	0.5	0.0	2.0	0.0	1.0			
Initial Q Delay(d3),s/veh	0.0	0.0	0.0	0.0	0.0	0.0	0.0	0.0	0.0			
%ile BackOfQ(50%),veh/ln	5.3	0.1	0.0	0.0	5.6	0.0	6.5	0.0	3.9			
Unsig. Movement Delay, s/veh						19.60						
LnGrp Delay(d),s/veh	44.8	0.3	0.0	0.0	14.6	19.6	44.4	0.0	41.8			
LnGrp LOS	D	A	A	A	B	B	D	A	D			
Approach Vol, veh/h		1350			1581	A		801				
Approach Delay, s/veh		15.2			15.8			43.4				
Approach LOS		B			B			D				
Timer - Assigned Phs		2			5	6		8				
Phs Duration (G+Y+Rc), s		85.5			20.3	65.2		24.5				
Change Period (Y+Rc), s		4.0			4.0	4.0		4.0				
Max Green Setting (Gmax), s		71.0			22.0	45.0		31.0				
Max Q Clear Time (g_c+I1), s		2.0			15.4	17.0		16.8				
Green Ext Time (p_c), s		13.2			0.9	14.4		3.7				
Intersection Summary												
HCM 6th Ctrl Delay				21.5								
HCM 6th LOS				C								
Notes												
User approved volume balancing among the lanes for turning movement.												
User approved changes to right turn type.												
Unsignalized Delay for [WBR] is included in calculations of the approach delay and intersection delay.												

Queuing and Blocking Report
Existing + Stage II + Project PM Peak Hour

06/16/2021

Intersection: 2: I-5 SB & Wilsonville Rd

Movement	EB	EB	EB	EB	WB	WB	WB	WB	SB	SB	SB	SB
Directions Served	T	T	T	R	L	L	T	T	L	LT	R	R
Maximum Queue (ft)	206	173	173	269	358	356	426	352	221	262	191	157
Average Queue (ft)	109	77	97	104	216	216	206	173	110	159	78	31
95th Queue (ft)	190	141	157	214	320	326	382	325	207	235	154	100
Link Distance (ft)		466	466	466	437	437	437	437		908	908	
Upstream Blk Time (%)					0	0	0					
Queuing Penalty (veh)					0	0	0					
Storage Bay Dist (ft)	245								450			365
Storage Blk Time (%)	0											
Queuing Penalty (veh)	0											

Intersection: 3: I-5 NB & Wilsonville Rd

Movement	EB	EB	EB	EB	WB	WB	WB	WB	NB	NB	NB	NB
Directions Served	L	L	T	T	T	T	T	R	L	LT	R	R
Maximum Queue (ft)	255	266	220	254	389	412	311	237	332	331	309	265
Average Queue (ft)	139	147	91	121	231	261	182	58	171	160	170	92
95th Queue (ft)	219	228	194	214	364	379	293	169	280	270	273	242
Link Distance (ft)	437	437	437	437	642	642	642			762		
Upstream Blk Time (%)												
Queuing Penalty (veh)												
Storage Bay Dist (ft)								300	360		360	360
Storage Blk Time (%)							0	0	0	0	0	0
Queuing Penalty (veh)							0	0	0	1	0	0

Zone Summary

Zone wide Queuing Penalty: 2

**PRELIMINARY,
NOT FOR
CONSTRUCTION**

IN THE EVENT CONFLICTS ARE DISCOVERED BETWEEN THE ORIGINAL SIGNED AND SEALED DOCUMENTS PREPARED BY THE ARCHITECTS AND/OR THEIR CONSULTANTS, AND ANY COPY OF THE DOCUMENTS TRANSMITTED BY MAIL, FAX, ELECTRONICALLY OR OTHERWISE, THE ORIGINAL SIGNED AND SEALED DOCUMENTS SHALL GOVERN.

PROJECT # 2020-122
DATE: 03/15/2021

REVISIONS

**GAS STATION / "C"-STORE
FAMILY MART**
29760 SW BOONES FERRY ROAD, WILSONVILLE OR 97070

SHEET:
A1.01

SITE PLAN GENERAL NOTES:

- THE LOCATIONS OF EXISTING UNDERGROUND UTILITIES ARE SHOWN IN AN APPROXIMATE WAY ONLY AND HAVE NOT BEEN INDEPENDENTLY VERIFIED BY THE OWNER OR ITS REPRESENTATIVES. THE CONTRACTOR SHALL DETERMINE THE EXACT LOCATION OF ALL EXISTING UTILITIES BEFORE COMMENCING WORK AND AGREES TO BE FULLY RESPONSIBLE FOR ANY AND ALL DAMAGES WHICH MIGHT BE OCCASIONED BY THE CONTRACTORS FAILURE TO EXACTLY LOCATE AND PRESERVE ANY AND ALL UNDERGROUND UTILITIES.
- REFER TO CIVIL DRAWINGS FOR GRADING. SITE IS REQUIRED TO MEET THE LAWS OF FHA AND ADA. ACCESSIBLE ROUTES SHALL NOT EXCEED 5% (1 IN 20) OR CROSS SLOPES SHALL NOT EXCEED 2% (1 IN 50). ALL AT GRADE SIDEWALKS ARE ACCESSIBLE ROUTES.
- JOINTS IN CONCRETE WALKS NOTED AS E.J. ARE TO BE CONSTRUCTED AS EXPANSION JOINTS. ALL OTHER JOINTS SHOWN, TO BE TOOLED CONTROL JOINTS, SEE CIVIL.
- PROVIDE CONSTRUCTION FENCING AS REQUIRED TO SECURE SITE AND BUILDING DURING CONSTRUCTION.
- SEE LANDSCAPE DRAWINGS FOR LANDSCAPE AND IRRIGATION ELEMENTS.
- EXTREME CARE SHOULD BE TAKEN TO PRESERVE EXISTING ROOTS OF TREES TO REMAIN.
- SEE ELECTRICAL DRAWINGS FOR SITE LIGHTING.

SITE DEVELOPMENT CODE REVIEW:

SITE AREA (BEFORE DEDICATION): 29,905.37sf = 0.6865ac
SITE AREA (AFTER 8'-6" DEDICATION): 28,835.32sf = 0.6620ac

ZONING: PDC Planned Development Commercial

BUILDING AREAS:
• BLDG 1 LEVEL 01: 3,460 sf

PARKING:
• COMMERCIAL USES: 4.1/1000sf REQ'D
• = 14 SPACES. (18 PROVIDED)

BIKE PARKING:
• 1 SPACES PER 4,000 sf; or 2 SPACES MINIMUM
• THEREFORE PROVIDE 2 BIKE PARKING SPACES.

LOADING SPACES:
• FOR BUILDINGS LESS THAN 5,000 sf NONE REQ'D

SITE AREA CALCULATIONS

DESCRIPTION	AREA sf	PERCENT	REMARKS
ACCESSORY STRUCTURES	216.00	0.75%	TRASH ENCLOSURE
ASPHALT PAVING	12,213.90	42.36%	
BUILDINGS	3,460.00	12.00%	
CONCRETE CURBS	326.03	1.13%	
CONCRETE FUEL PAD	5,850.60	20.29%	
CONCRETE PAVING - MISC.	395.33	1.37%	
CONCRETE SIDEWALKS	1,016.81	3.53%	
LANDSCAPING	5,356.65	18.58%	15% REQUIRED
MISCELLANEOUS	0.00	0.00%	
9	28,835.32	100.00%	

CANOPY AREA CALCULATIONS

COVER DESCRIPTION	COVER AREA sf	PERCENT	COVER REMARKS
VEHICLE FUELING CANOPY	3,547.24	93.78%	
BUILDING CANOPIES	235.34	6.22%	
2	3,782.58	100.00%	

SITE PLAN NOTES:

- EXISTING CURBS, DRIVES, ASPHALT AND PARKING ON ADJACENT SITE TO REMAIN.
- EXISTING SHARED ACCESS DRIVEWAY.
- DRIVE-UP SERVICE WINDOW FOR CONVENIENCE STORE.
- TRASH ENCLOSURE
- RAISED PEDESTRIAN CROSSING
- SHORT-TERM BICYCLE PARKING
- STORMWATER FACILITY
- 30' PYLON SIGN
- 4' x 8' MONUMENT SIGN

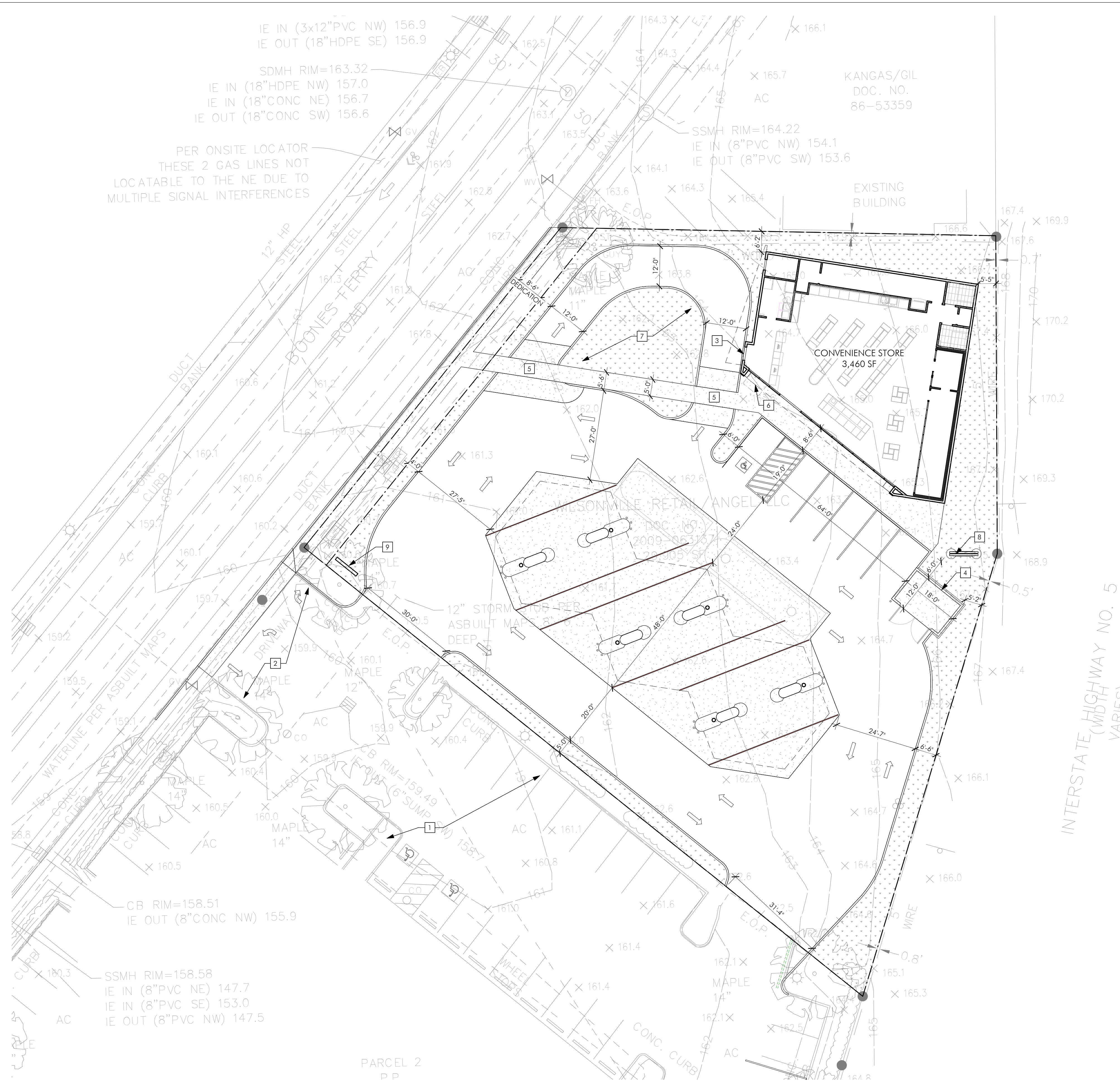

1 SITE PLAN
0' 4' 8' 16' 24' 48' 1/16" = 1'-0"



**PRELIMINARY,
NOT FOR
CONSTRUCTION**

IN THE EVENT CONFLICTS ARE DISCOVERED
BETWEEN THE ORIGINAL SIGNED AND SEALED
DOCUMENTS PREPARED BY THE ARCHITECTS
AND/OR THEIR CONSULTANTS, AND ANY COPY OF
THE DOCUMENTS TRANSMITTED BY MAIL, FAX,
ELECTRONICALLY OR OTHERWISE, THE ORIGINAL
SIGNED AND SEALED DOCUMENTS SHALL GOVERN.

PROJECT # 2020-122
DATE: 03/15/2021

REVISIONS

FAMILY MART

GAS STATION / CONVENIENCE STORE

29760 SW BOONES FERRY ROAD, WILSONVILLE, OR 97070

SITE VICINITY MAP:

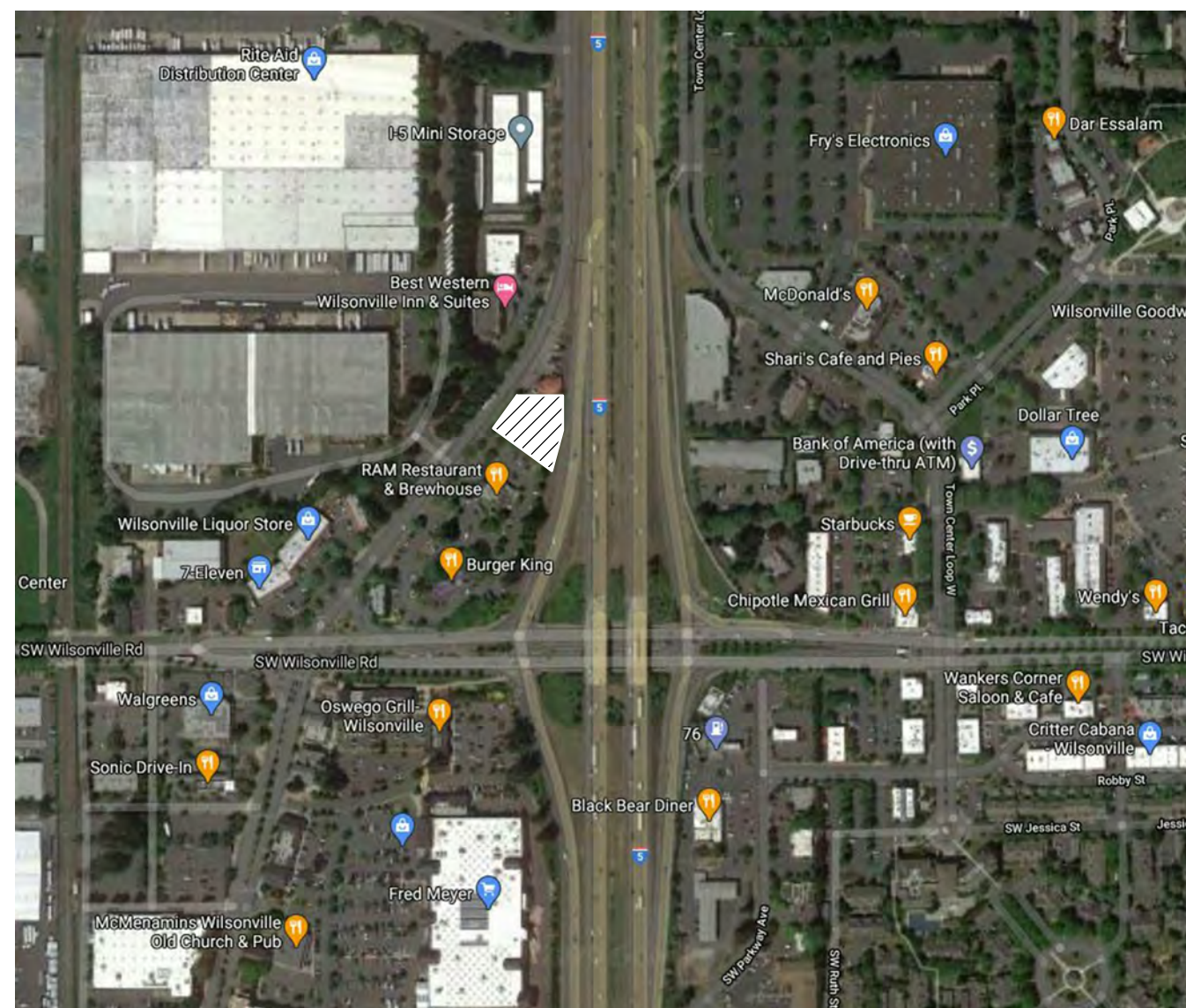

SITE MAP:

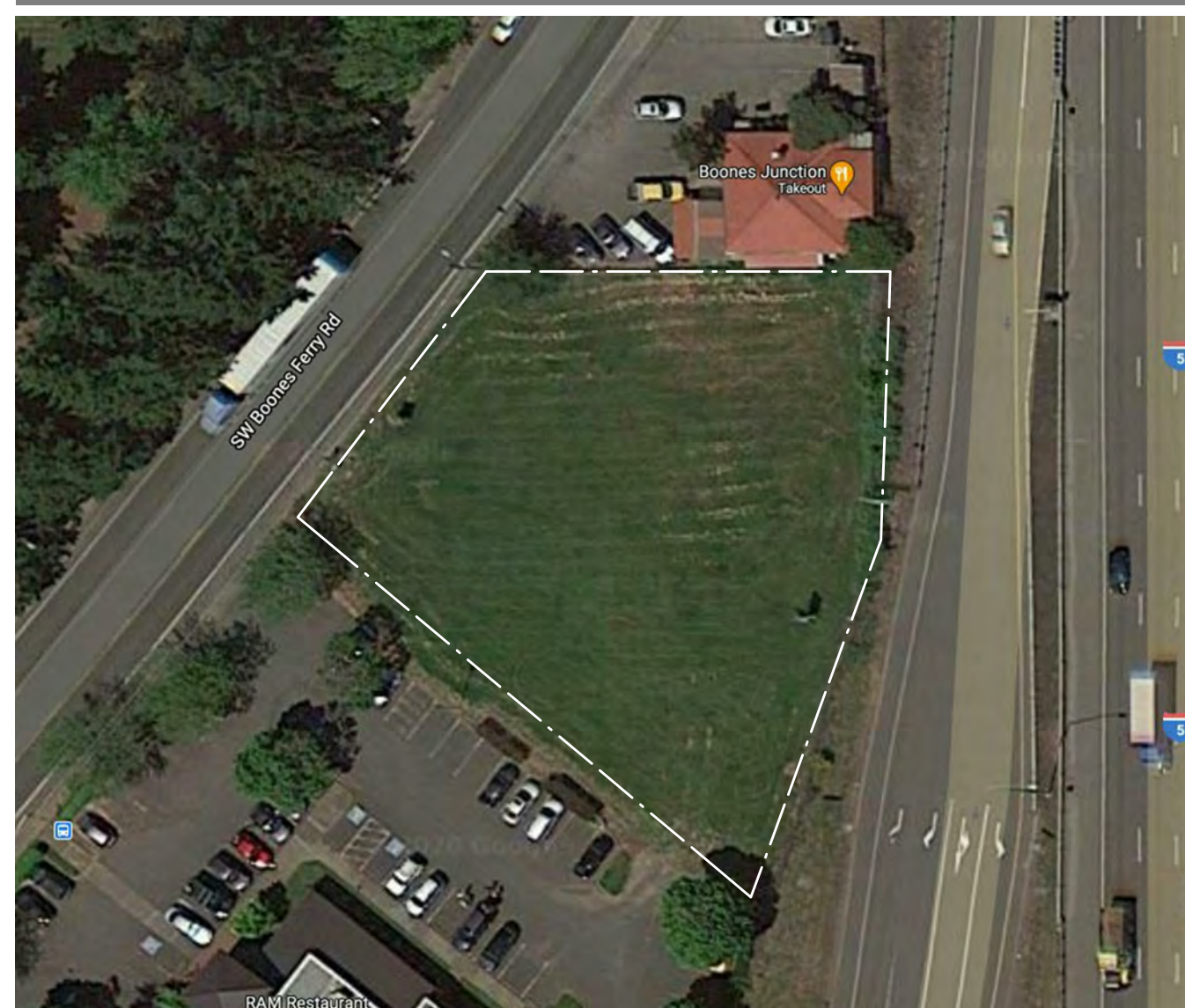

DRAWINGS LIST:

Sheet Number	Sheet Name	Sheet Issue Date	Current Revision	Revision Description	Sheet Number	Sheet Name	Sheet Issue Date	Current Revision	Revision Description
GENERAL DRAWINGS									
G0.01	COVER SHEET	03/08/2021			A4.01	DETAIL RESTROOM PLANS	03/08/2021		
G0.02	GENERAL NOTES	03/08/2021			A4.11	DETAIL STAIR PLANS	03/08/2021		
G1.01	CODE REVIEW PLANS	03/08/2021			A5.01	SITE DETAILS	03/08/2021		
G3.01	PERSPECTIVE VIEWS	03/08/2021			A5.02	UNDERGROUND FUEL TANK ANCHORAGE	03/08/2021		
G3.02	PERSPECTIVE VIEWS	03/08/2021			A5.21	EXTERIOR DETAILS	03/08/2021		
ARCHITECTURAL DRAWINGS									
A0.21	WALL TYPES	03/08/2021			A5.22	EXTERIOR DETAILS	03/08/2021		
A1.01	SITE PLAN	03/08/2021			A5.41	INTERIOR DETAILS	03/08/2021		
A1.11	LEVEL 01 - DEMOLITION PLAN	03/08/2021			A5.42	INTERIOR DETAILS	03/08/2021		
A1.21	LEVEL 01 - FLOOR PLAN	03/08/2021			A6.01	SCHEDULES	03/08/2021		
A1.21a	LEVEL 01 - FLOOR PLAN	03/08/2021							
A1.61	LEVEL 01 - REFLECTED CEILING PLAN	03/08/2021							
A2.01	ELEVATIONS	03/08/2021							
A2.02	ELEVATIONS	03/08/2021							
A2.51	INTERIOR ELEVATIONS	03/08/2021							
A3.01	BUILDING SECTIONS	03/08/2021							
A3.02	BUILDING SECTIONS	03/08/2021							
A3.11	WALL SECTIONS	03/08/2021							

PROJECT TEAM:

OWNER:
DAR USA INC
2902 Mount Vernon St SE Albany OR 97322
Dee Arora, Managing Member
P: 541.500.0123 E: dee@darusa1.com W: www.darusa.com

ARCHITECT:
STUDIO 3 ARCHITECTURE, Inc.
275 Court Street St. NE Salem OR 97303-3442
Project Architect: Leonard Lodder, AIA, LEED AP
P: 503.390.6500 D: 971.239.0207 E: leonard@studio3architecture.com
W: www.studio3architecture.com

CIVIL ENGINEERING:
CONSTRUCTION ENGINEERING CONSULTANTS, Inc
132 West Main St., Medford OR 97501
Brandon Hall, EIT
P: 541.779.5268 E: brandon@cecengineering.com

LANDSCAPE ARCHITECT:
LAURUS DESIGNS, LLC
1012 Pine Street Silverton OR 97381
Laura A. Antonson, LA
P: 503.784.6494 E: laura_a_antonson@hotmail.com

STRUCTURAL ENGINEERING:
MSC ENGINEERS, INC.
1045 13th St. SE Salem, OR 97302-2506
Cameron Swearingen, P.E.
P: 503.399.1399 E: cameron@mscengineers.com

MECHANICAL ENGINEERING:
COLEBREIT ENGINEERING
2021 NW Grant Ave. Corvallis, OR 97330
Adam Boyd, P.E.
P: 541.728.3293 E: adamboyd@colebreit.com

ELECTRICAL ENGINEERING:
Design-Build

GENERAL CONTRACTOR
DAR USA CONSTRUCTION LLC.
2902 Mount Vernon St SE Albany OR 97322
James Sullivan, Project Manager
P: 760.792.7224 E: james@darusa1.com W: www.darusa.com

SYMBOL LEGEND:

ELEVATION DATUM:	WINDOW TYPE:
100.00 F.F.E.	REFER TO WINDOW ELEVATIONS SHOWN ON DRAWINGS AS 1X
SECTION REFERENCE:	DOOR NUMBER:
FILLED ARROW DENOTES BUILDING SECTION	DOOR SIZE OR NUMBER
OPEN ARROW DENOTES WALL SECTION/DETAIL	PLAN NOTE DESIGNATION
1 A3.11	PLAN OR SIDE NOTE NUMBER
1 A3.11	MARK OR DIAGONAL NOTE NUMBER
1 A3.11	REVISION NUMBER
1 A3.11	ROOM TITLE + NUMBER:
1 A3.11	ROOM NAME
1 A3.11	ROOM NUMBER
ELEVATION REFERENCE:	WALL TYPE MARK:
ELEVATION NUMBER OR DESIGNATION AS OCCURS	WALL OR PARTITION CONSTRUCTION TYPE. SEE LEGEND.
SHEET NUMBER	
DETAIL REFERENCE:	
SHEET NUMBER	
SIDE NOTE IF REQUIRED	
DETAIL CUT LOCATION IF SHOWN	

**GAS STATION / "C"-STORE
FAMILY MART**
29760 SW BOONES FERRY ROAD, WILSONVILLE OR 97070

SHEET:

GO.01

PRELIMINARY,
NOT FOR
CONSTRUCTION

IN THE EVENT CONFLICTS ARE DISCOVERED
BETWEEN THE ORIGINAL SIGNED AND SEALED
DOCUMENTS PREPARED BY THE ARCHITECTS
AND/OR THEIR CONSULTANTS, AND ANY COPY OF
THE DOCUMENTS TRANSMITTED BY MAIL, FAX,
ELECTRONICALLY OR OTHERWISE, THE ORIGINAL
SIGNED AND SEALED DOCUMENTS SHALL GOVERN.

PROJECT # 2020-122
DATE: 03/15/2021

REVISIONS



1 3D VIEW FROM SOUTH WEST



2 3D VIEW FROM NORTH WEST



3 3D VIEW FROM PUMPS

GAS STATION / "C"-STORE
FAMILY MART
29760 SW BOONES FERRY ROAD, WILSONVILLE OR 97070

SHEET:

G3.01



PRELIMINARY DRAINAGE REPORT

Wilsonville Convenience Store Wilsonville, OR

Prepared by:

**PLS Engineering
Consulting Engineers and Planners
604 W. Evergreen Blvd.
Vancouver, WA 98660
PH: (360) 944-6519
andrew@plsengineering.com**

Prepared for:

**Oregon Architecture, Inc.
Attn: Mark McKechnie
132 W. Main Street, Suite 101
Medford, OR 97501
PH: (541)772-4372**

Submitted: March 2022

Revised: May 2022

TABLE OF CONTENTS

CERTIFICATE OF ENGINEER2

PROJECT DESCRIPTION3

EXISTING CONDITIONS.....3

DEVELOPED CONDITIONS3

STORMWATER ANALYSIS.....5

VICINITY MAP:2

SOILS MAP3

Technical Appendix:

Appendix A: GENERAL MAPS

- **Vicinity Map**
- **Soils Map**

Appendix B: BASIN MAP

Appendix C: BMP SIZING TOOL OUTPUT REPORT

Appendix D: HYDROCAD MODEL OF INFILTRATION TRENCH

Appendix E: GEOTECHNICAL REPORT

CERTIFICATE OF ENGINEER

Wilsonville Convenience Store

Preliminary Drainage Report

The technical information and data contained in this report was prepared under the direction and supervision of the undersigned, whose seal, as a professional engineer licensed to practice as such, is affixed below.



This document was:

Prepared by:

Andrew J. Gunther, PE

Project Description

Site Information

The proposed Wilsonville Convenience Store site has a tax lot ID of 31W14D 0090 and a site address of 29760 SW Boones Ferry Rd, Wilsonville, OR. The site is located approximately 900 feet north of the intersection of SW Wilsonville Road & SW Boones Ferry Road along the east side of the road immediately north of the existing RAM Restaurant and Brewery. The site covers approximately 0.69 acres and is zoned Planned Developed Commercial (PDC). The site is bordered on the east by the southbound I-5 offramp.

The site is currently vacant and covered in grass. Site access will be via new driveways from the existing restaurant site to the south at the southwest and southeast corners of the property. The project would develop the existing vacant parcel into a gas station and convenience store together. The convenience store would total approximately 3,000 square feet and the fuel island would contain six gas pumps and 12 fueling positions. The convenience store would include a drive-thru on the west side of the building. In addition to site development, the project will provide partial frontage improvements along SW Boones Ferry Road including a planter strip and detached sidewalk. This would necessitate a small right-of-way dedication along the site frontage.

Existing Conditions

The site is currently vacant and covered in grass. The site is gently sloping from the northeast to the southwest with average slopes of less than 5%. Surrounding properties have been developed such that there is little or no upstream runoff entering the site. Existing conditions show that site runoff drains from northeast to southwest across the site and ultimately to SW Boones Ferry Road and/or the adjacent restaurant property to the south.

Site soils mapping by the Natural Resource Conservation Service (NRCS) was researched and indicates that the site contains Willamette silt loam, gravelly substratum (87A) type soils. In general, the NRCS considers Willamette silt loam soils to have low to moderate infiltration. The generalized typical soil profile for these soils found in the NRCS Soil Survey indicates that the shallow silt loam soils quickly transition to a more gravelly loam texture with infiltration rates generally in the range of approximately two to six inches per hour. A geotechnical investigation was recently completed by Earth Engineering, Inc. which included infiltration testing at a depth of approximately 3 feet below the native ground surface. The measured infiltration rate found in the testing was 4" per hour. Similar to the NRCS's generalized soil profile description, the site investigation found that there was increasing gravel content with greater soil depth.

Developed Conditions

As stated previously, the project proposes to develop a fueling station, 3,000 square foot convenience store with drive-thru window, parking areas and associated drive aisles. Site access would be via the restaurant site south of the project with access drives to the neighboring site at the southwest and southeast corners of the property. After development, approximately 0.11 acres of the property would be covered in landscaping and stormwater facilities with the remainder of the site covered in roof areas, pavement, and sidewalk. A canopy would be provided over the vehicle fueling areas.

In order to mitigate for stormwater impacts associated with proposed project, two separate runoff treatment and flow control systems are proposed. A northerly stormwater infiltration rain garden facility would be constructed in the landscape island that is surrounded by the drive-thru lane along the west side of the building. The other facility would be a two-step drainage system that would include a filtration stormwater planter in the proposed landscape island along the site's south boundary which would drain into a stormwater infiltration trench via an overflow drain elevated above the base of the planter. The infiltration trench would be located under the driveway aisle between the landscape island containing the stormwater planter and the vehicle fueling pad to the north. The infiltration rain garden in the north part of the site would treat and infiltrate runoff from the convenience store as well as the drive-thru loop west of the building while the filtration stormwater planter and subsurface infiltration trench in the south part of the site would treat and infiltrate the remainder of the project runoff.

For each of these facilities, the tributary pavement and sidewalk runoff would travel via surface flow across the pavement to curb cuts in the curb lines that would allow the runoff to enter the facility. Runoff from the convenience store would be collected via roof drains and directed to shallow storm sewer piping that would outlet to the base of the infiltration rain garden while runoff from the fueling canopy would be directed to roof downspouts and then piped directly to the infiltration trench in the south part of the site, allowing for a reduced size for the stormwater planter since the canopy runoff would not need pre-treatment prior to entering the infiltration trench.

While the roof canopy over the fueling island area will drain to the infiltration trench in the south part of the site, the drainage area under the fueling island canopy will be self-contained. Area under the fueling canopy will drain from north to south to a trench drain running along the south edge of the covered area. The trench drain will collect runoff only from the area under the canopy. Areas not under the fueling canopy will be sloped to drain away from the trench drain and into the treatment stormwater planter. Based on our review of the city's stormwater regulations and discussion with Wilsonville Engineering staff, we understand that the area under the canopy is to be drained first through an oil/water separator and then into a spill control manhole. This spill control manhole would be isolated with a shutoff valve on the downstream side of the manhole which would remain normally closed. Downstream of the shutoff valve, the discharge piping from the spill control manhole will drain to the city's sanitary sewer system.

It is understood that the City of Wilsonville prefers the use of surface "green" LID stormwater ponding/infiltration facilities for runoff treatment and flow control rather than subsurface facilities, where possible. PLS Engineering has tried to utilize these facility types to the maximum extent possible. Unfortunately, based on site topography and space constraints, it is not feasible to accomplish all of the site's stormwater flow control requirements using only "green" above-ground facilities. It is our understanding that the city will allow subsurface underground injection control (UIC) infiltration facilities for this property provided that they can be permitted with the Oregon DEQ. We have discussed the project in detail with Kevin Weberling, Senior Hydrogeologist with the Northwest Region of the DEQ and he believes the proposed infiltration trench can be permitted on this site as a rule authorized system. Review of state drinking well mapping indicates there are no domestic wells within 500 feet of the site and state water resource mapping indicates the site is not within the 2-year travel time of any public water supply wells. It is anticipated that a UIC permit will be required for the infiltration trench and that periodic sampling of stormwater entering the system

will be required. As a result, a sedimentation manhole fitted with a sump is proposed upstream of the infiltration trench at the point that overflow runoff from the upstream treatment rain garden would discharge.

Stormwater Analysis

Preliminary sizing for the two stormwater facilities proposed on the site has been completed using the WES BMP Sizing Tool and the resulting calculations are provided in Appendix C. The calculations are based on the drainage basins delineated on the Basin Map provided in Appendix B. As shown on the Basin Map, the site has been divided into two drainage basins with Basin 1 in the north part of the property containing the convenience store and the drive-thru area west of the building and Basin 2 containing the remainder of the property. Basin 2 was further divided into two subbasins (Basin 2 and Basin 2B) with Basin 2B containing the area of the fueling island canopy. As mentioned previously, everything in Basin 2 except for the canopy area will be tributary to the treatment stormwater planter on the south property boundary while the canopy area will drain directly to the downstream infiltration trench via trench drains lining the south side of the fuel island area.

In sizing each of the stormwater facilities using the BMP Sizing Tool, the analysis was completed using A1 type soils based on the tested infiltration rate of 4"/hour measured by the project geotechnical engineer (per report in Appendix E). Pre-development conditions were modeled as grass. As mentioned previously, the northern rain garden was sized to provide both treatment and flow control via infiltration. The sizing calculations indicate a required surface area of 532 square feet as measured 12" above the base of the facility.

The available footprint for the stormwater planter serving Basin 2 is quite limited. While conceptual calculations were performed to see if adequate area was available to construct a facility providing both treatment and runoff flow control, it was readily apparent that adequate space was not available for a surface LID facility that could infiltrate adequate runoff to meet quantity control requirements. As a result, the southern facility has been sized as a filtration stormwater planter intended only to provide stormwater treatment. The required surface area for this facility as measured at a depth of 12" above the base of the facility is 241 square feet. As space is limited to construct the stormwater planter, the growing media depth will be increased to 30 inches in this planter to reduce the required surface area. Per The City's Stormwater Planter – Filtration detail, a surface area reduction of 25% is allowed when the growing medium depth is increased to a minimum of 30 inches. This will allow the required facility surface area to be reduced by 25% from the standard 241 square feet to 181 square feet (2.5'x72.4') as shown in the preliminary drawings.

An infiltration trench consisting of a perforated pipe surrounded by drain rock is proposed downstream of the filtration rain garden to provide flow control for all runoff from Basins 2 and 2B. The capacity of the infiltration trench has been analyzed using HydroCAD. As stated earlier, infiltration testing resulted in a measured infiltration rate of 4"/hr. A design infiltration rate of 2"/hr was used in sizing the trench representing a safety factor of 2 applied to the tested rate. The analysis used a 10-year, 24-hour storm rainfall depth of 3.45" and the rainfall was assumed to follow a Type 1-A storm distribution. This analysis methodology is consistent with the guidance provided in the city's stormwater regulations. The infiltration trench has been sized to fully infiltrate the 10-year storm event and the resulting trench size is 11' wide by 3' deep by 100' long. For larger storm events, an overflow will be provided at the west end of the infiltration trench via the sedimentation/overflow manhole. The overflow piping will drain to a storm sewer stub that was previously extended to this

property when the site containing the Ram Restaurant and Brewery was developed. The storm stub ultimately discharges to the storm sewer in Boones Ferry Road.

Given that the storm pipe was extended to this site from the property to the south, it is clear that a future drainage connection was anticipated when the RAM site was originally developed as a Chili's restaurant. The runoff leaving this site will be reduced compared to existing conditions as all runoff from Basin 2 which covers most of the property will be fully infiltrated for storms up to the 10-year storm and a significant portion of the runoff from Basin 1 containing the rest of the property will be infiltrated.

APPENDIX A

General Maps

- **Vicinity Map**
- **Soils Map**

Vicinity Map:

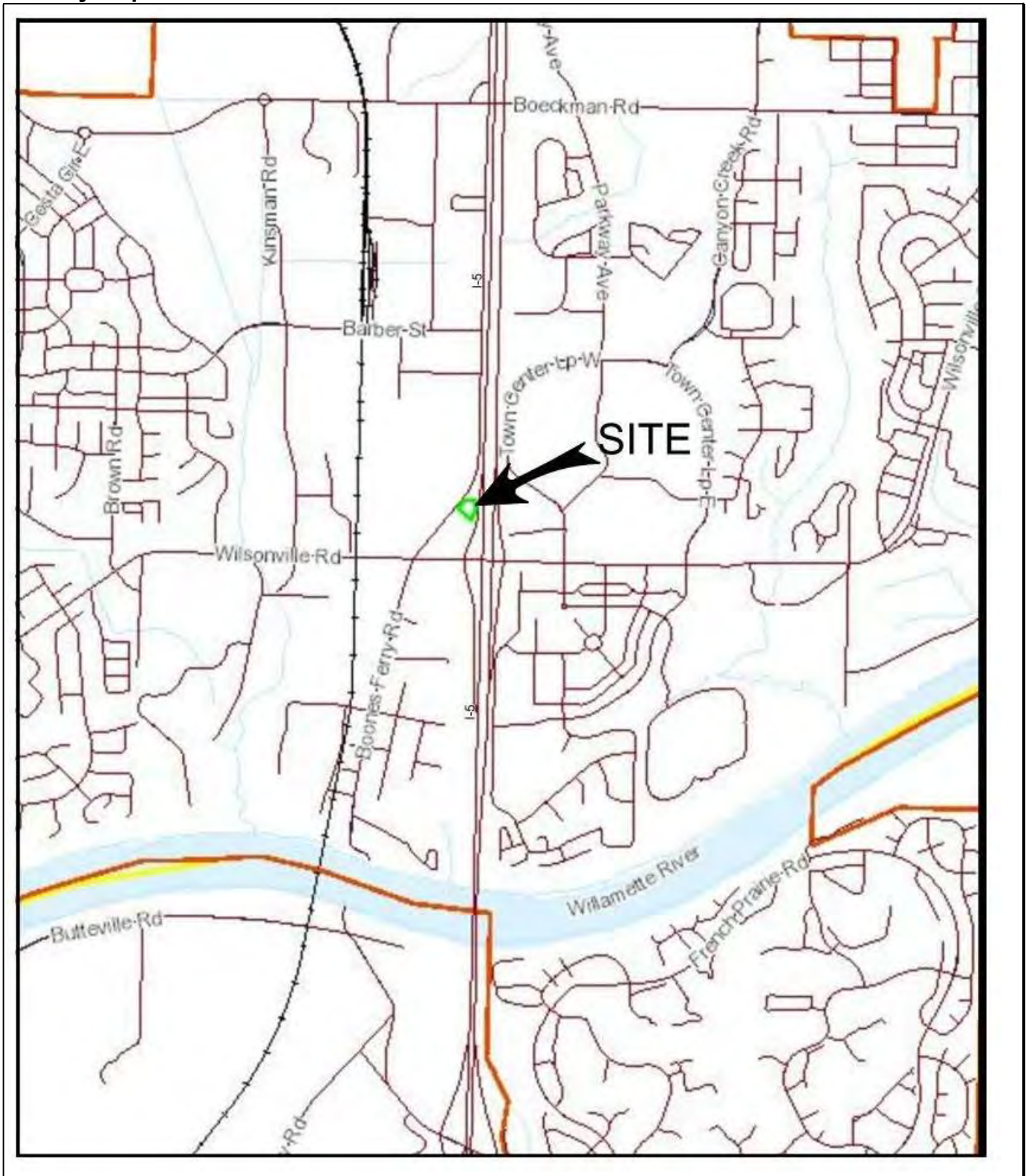

Soils Map

Willamette silt loam (87A)



APPENDIX B

Basin Map

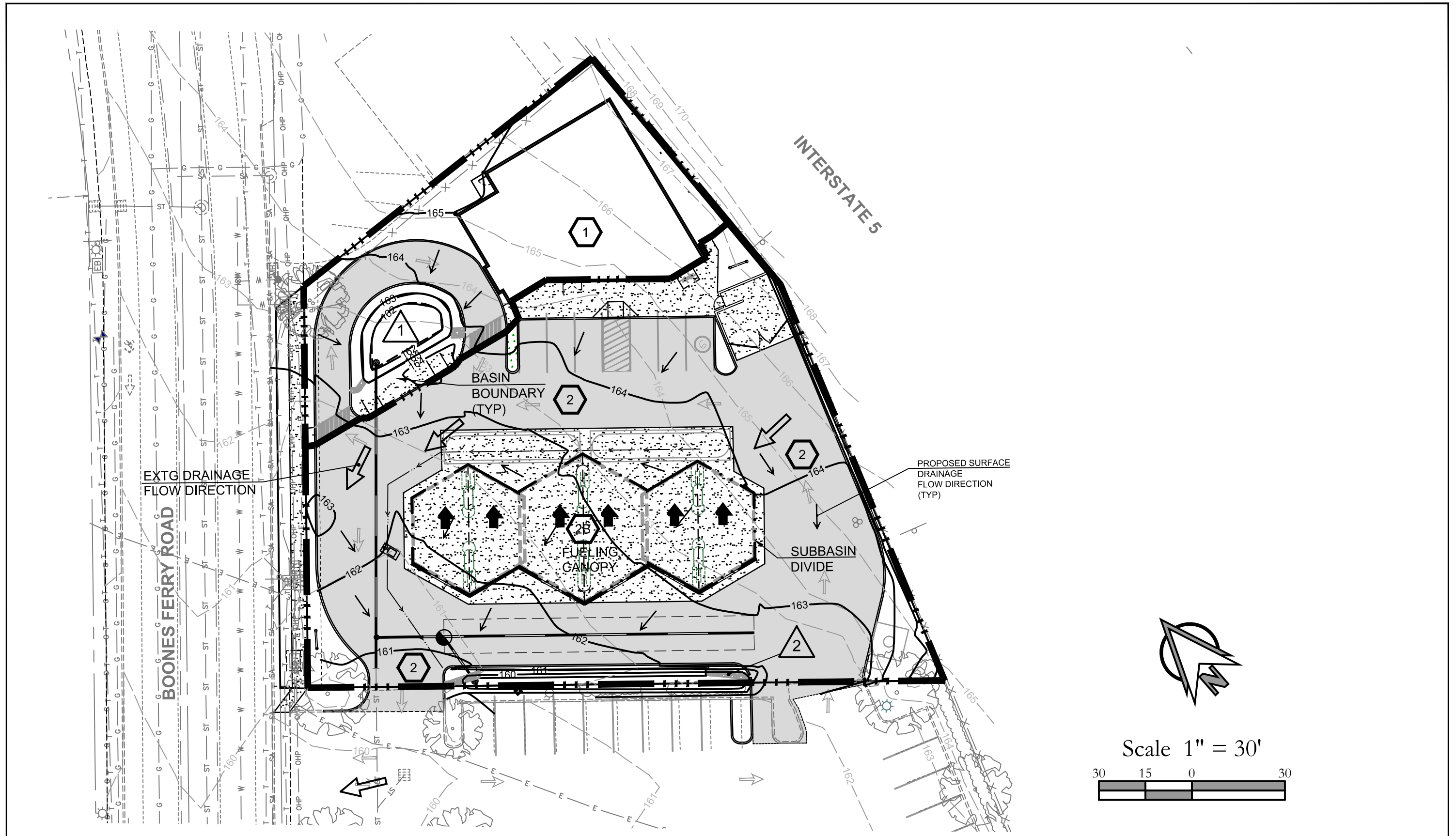

Post Development Basin Map For:
Wilsonville Convenience Store
 A Site Located in Wilsonville, OR

PLS ENGINEERING	DESIGNED BY: AJG	SCALE: H: 1"=30' V: N/A	SHEET
	DRAFTED BY: RLS	DATE: 5-18-22	1
	REVIEWED BY: AJG	PROJECT NO.:	1

APPENDIX C

BMP Sizing Tool Output Report

WES BMP Sizing Report

Project Information

Project Name	Wilsonville Gas Station
Project Type	Commercial
Location	29800 SW Boones Ferry Road
Stormwater Management Area	0
Project Applicant	
Jurisdiction	OutofDistrict

Drainage Management Area

Name	Area (sq-ft)	Pre-Project Cover	Post-Project Cover	DMA Soil Type	BMP
2RG- land	2,123	Grass	LandscapeBsoil	B	BMP 2 Rain Garden
2RG - Pavement	15,435	Grass	ConventionalConcrete	B	BMP 2 Rain Garden
2RG - Roof	3,702	Grass	Roofs	B	NA
1RG Roof	3,000	Grass	Roofs	B	BMP 1 Rain Garden
1RG Land	2,633	Grass	LandscapeBsoil	B	BMP 1 Rain Garden
1RG Pave	1,534	Grass	ConventionalConcrete	B	BMP 1 Rain Garden

LID Facility Sizing Details

LID ID	Design Criteria	BMP Type	Facility Soil Type	Minimum Area (sq-ft)	Planned Areas (sq-ft)	Orifice Diameter (in)
BMP 2 Rain Garden	WaterQuality	Rain Garden - Infiltration	A1	241.1	0.0	0.0
BMP 1 Rain Garden	FlowControlAndTreatment	Rain Garden - Infiltration	A1	532.4	0.0	0.0

Pond Sizing Details

1. FCWQT = Flow control and water quality treatment, WQT = Water quality treatment only
2. Depth is measured from the bottom of the facility and includes the three feet of media (drain rock, separation layer and growing media).
3. Maximum volume of the facility. Includes the volume occupied by the media at the bottom of the facility.

4. Maximum water storage volume of the facility. Includes water storage in the three feet of soil media assuming a 40 percent porosity.

APPENDIX D

HydroCAD Model of Infiltration Trench

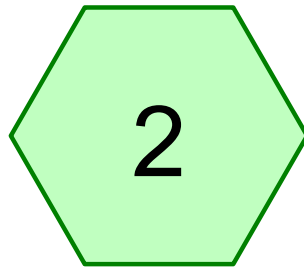

Basin 2

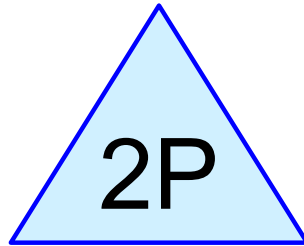
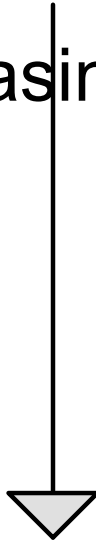

11'x100'x3'

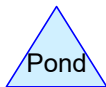
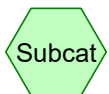

prelim

Prepared by HP Inc.

HydroCAD® 10.00 s/n 04953 © 2011 HydroCAD Software Solutions LLC

Wilsonville Convenience Store
Type IA 24-hr 10-yr Rainfall=3.45"

Printed 5/18/2022

Page 2

Time span=0.00-24.00 hrs, dt=0.05 hrs, 481 points
Runoff by SBUH method, Split Pervious/Imperv.
Reach routing by Stor-Ind+Trans method - Pond routing by Stor-Ind method

Subcatchment 2: Basin 2

Runoff Area=21,260 sf 90.01% Impervious Runoff Depth>3.05"
Tc=6.0 min CN=80/98 Runoff=0.37 cfs 0.12399 af

Pond 2P: 11'x100'x3'

Peak Elev=2.73' Storage=1,211 cf Inflow=0.37 cfs 0.12399 af
Outflow=0.08 cfs 0.11881 af

Total Runoff Area = 0.488 ac Runoff Volume = 0.12399 af Average Runoff Depth = 3.05"
9.99% Pervious = 0.049 ac 90.01% Impervious = 0.439 ac

prelim

Prepared by HP Inc.

HydroCAD® 10.00 s/n 04953 © 2011 HydroCAD Software Solutions LLC

Wilsonville Convenience Store
Type IA 24-hr 10-yr Rainfall=3.45"

Printed 5/18/2022

Page 3

Summary for Subcatchment 2: Basin 2

Runoff = 0.37 cfs @ 7.92 hrs, Volume= 0.12399 af, Depth> 3.05"

Runoff by SBUH method, Split Pervious/Imperv., Time Span= 0.00-24.00 hrs, dt= 0.05 hrs
Type IA 24-hr 10-yr Rainfall=3.45"

	Area (sf)	CN	Description
*	15,435	98	pavement
*	2,123	80	landscape
*	3,702	98	roof
	21,260	96	Weighted Average
	2,123	80	9.99% Pervious Area
	19,137	98	90.01% Impervious Area

Tc (min)	Length (feet)	Slope (ft/ft)	Velocity (ft/sec)	Capacity (cfs)	Description
6.0					Direct Entry,

Subcatchment 2: Basin 2

Hydrograph

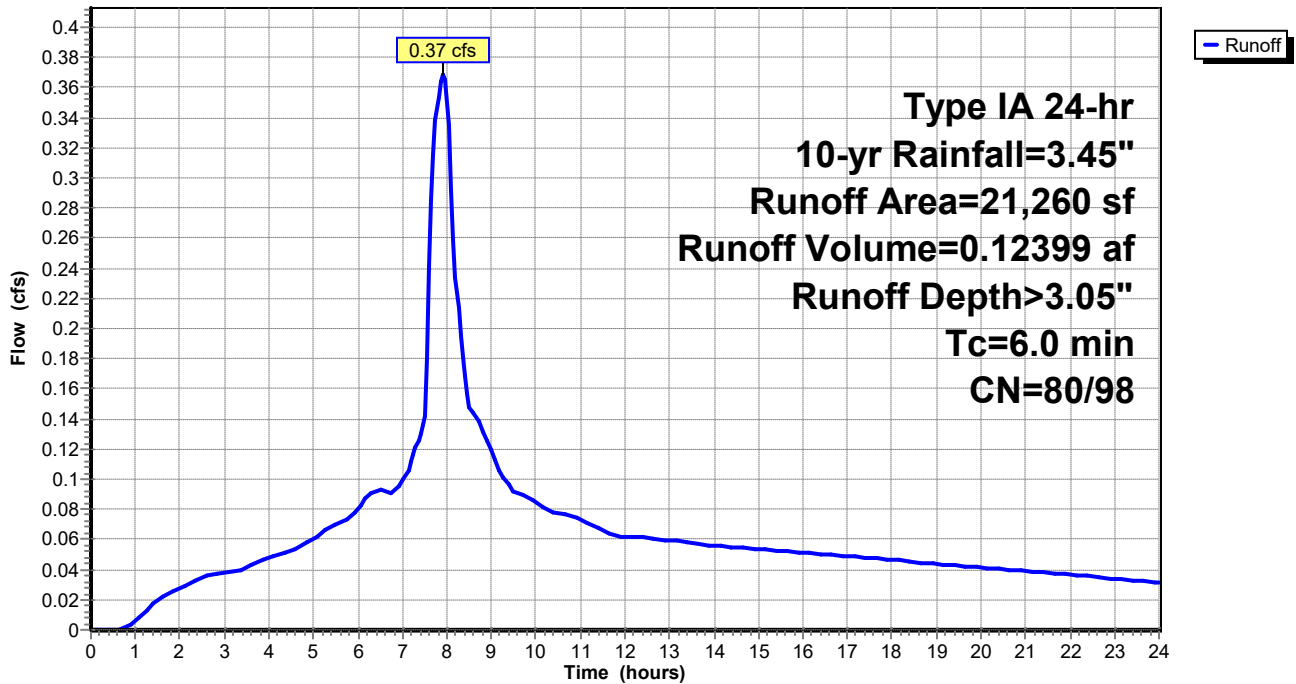

prelim

Prepared by HP Inc.
 HydroCAD® 10.00 s/n 04953 © 2011 HydroCAD Software Solutions LLC

Summary for Pond 2P: 11'x100'x3'

Inflow Area = 0.488 ac, 90.01% Impervious, Inflow Depth > 3.05" for 10-yr event
 Inflow = 0.37 cfs @ 7.92 hrs, Volume= 0.12399 af
 Outflow = 0.08 cfs @ 10.28 hrs, Volume= 0.11881 af, Atten= 79%, Lag= 141.4 min
 Discarded = 0.08 cfs @ 10.28 hrs, Volume= 0.11881 af

Routing by Stor-Ind method, Time Span= 0.00-24.00 hrs, dt= 0.05 hrs
 Peak Elev= 2.73' @ 10.28 hrs Surf.Area= 1,100 sf Storage= 1,211 cf

Plug-Flow detention time= 159.4 min calculated for 0.11881 af (96% of inflow)
 Center-of-Mass det. time= 128.4 min (799.9 - 671.6)

Volume	Invert	Avail.Storage	Storage Description
#1	0.00'	994 cf	11.00'W x 100.00'L x 3.00'H Prismatic 3,300 cf Overall - 314 cf Embedded = 2,986 cf x 33.3% Voids
#2	0.50'	314 cf	24.0" D x 100.0'L Pipe Storage Inside #1
		1,308 cf	Total Available Storage

Device	Routing	Invert	Outlet Devices
#1	Discarded	0.00'	2.000 in/hr Exfiltration over Wetted area

Discarded OutFlow Max=0.08 cfs @ 10.28 hrs HW=2.73' (Free Discharge)
 ↑1=Exfiltration (Exfiltration Controls 0.08 cfs)

Pond 2P: 11'x100'x3'

Hydrograph

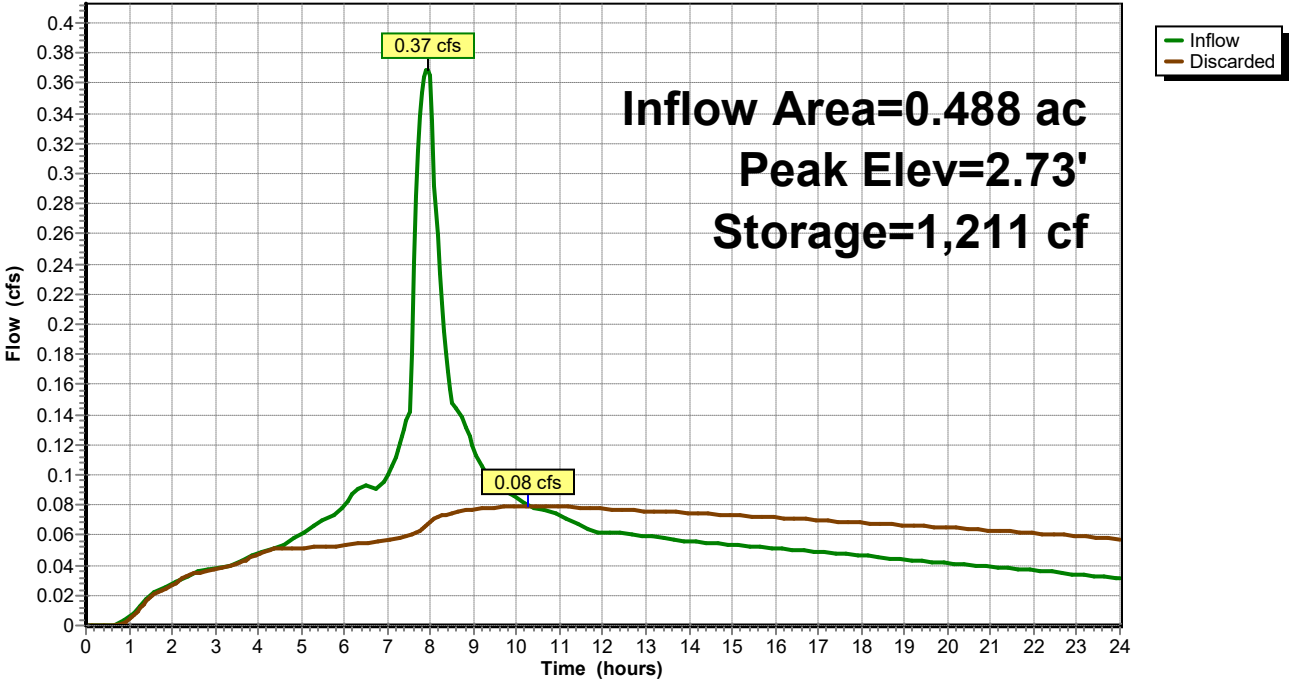

APPENDIX E

Geotechnical Report

GEOTECHNICAL ENGINEERING STUDY

Wilsonville Convenience Store
29760 Boones Ferry Road
Wilsonville, Clackamas County, Oregon 97070
Tax Lot No. (31W14D01002)

Prepared for:
Laz Ayala
132 West Main Street
Medford, Oregon 997501

Prepared By:

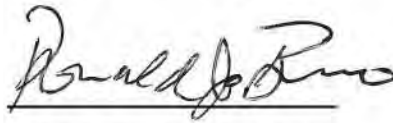

Donald J. Bruno, CEG
Engineering Geologist



EXPIRES: 12-31-2022

Mia Mahedy, PE,GE
Project Engineer

Project No. G14-0322

{April 2022}

Earth Engineering Inc.
PO Box 1512, Ridgefield, Washington 98642
(360) 600-6518

Earth Engineering, Inc.

Geotechnical & Environmental Consultants

Laz Ayala
132 West Main Street
Medford, Oregon 97501

April 22, 2022
G14-0322

**Subject: Geotechnical Engineering Study
Wilsonville Convenience Store
29760 Boones Ferry Road, Wilsonville, Clackamas County, Oregon
(Tax Lot No. 31W14D01002)**

Hello Laz,

We are pleased to submit our engineering report for the subject property located in Wilsonville, Oregon. This report presents the results of our field exploration, selective laboratory tests, field testing and engineering analyses.

Based on the results of this study, it is our opinion that construction of the proposed commercial structure is feasible from a geotechnical standpoint, provided recommendations presented in this report are included in the project design.

We appreciate the opportunity to have been of service to you and look forward to working with you in the future. Should you have any questions about the content of this report, or if we can be of further assistance, please call.

Respectfully Submitted,
Earth Engineering Inc.,



Donald J. Bruno, CEG
Engineering Geologist

TABLE OF CONTENTS
{G14-0322}

INTRODUCTION 1
 General 1
 Project Description 1

SITE CONDITIONS 1-2
 Surface 1
 Subsurface 2
 Groundwater 2
 General Regional Geology 2

LABORATORY TESTING 2-3

SEISMIC HAZARD EVALUATION 3-4

DISCUSSION AND RECOMMENDATIONS 4
 General 4
 Site Preparation & Grading 4-5
 Foundations 5-6
 Slab on Grade 6
 Temporary Excavations 6-7
 Infiltration Testing 7
 Site Drainage 7
 Utility Support & Back Fill 8
 Pavements 8-9
 Additional Services 9

LIMITATIONS 10

GRAPHICS

Figure 1	Vicinity Map
Figure 2	Site Plan (Test Pit & Infiltration Locations)
Figure 3	Typical Footing Drain Detail
Figure 4	Typical Utility Trench Back Fill Detail

APPENDICES

Appendix A	Field Exploration
Plate A1	Unified Soil Classification- Legend
Plates A2-A4	Log of Exploratory Test Pits
Appendix B	Field Exploration
Plate B1	Atterberg Limits

INTRODUCTION

General

This report presents the results of the geotechnical engineering study completed by Earth Engineering, Inc. for the proposed convenience store and fuel pumping facility located in Wilsonville, Clackamas County, Oregon. The general location of the site is shown on the *Vicinity Map, Figure 1*. At the time our study was performed, the site and our exploratory locations are approximately as shown on the *Site Plan, Figure 2*.

The purpose of this study was to explore subsurface conditions at the site and based on the conditions encountered provide geotechnical recommendations for the proposed construction. In addition this report includes infiltration testing for stormwater design and a seismic hazard evaluation.

Project Description

Based on the information that was provided to us by Oregon Architecture and the project civil engineer (PLS), it is our understanding the site will be developed with a one story building that will provide three- thousand one-hundred (3100) square feet of floor space, a pumping island, a trash enclosure, and an asphalt paved access driveway with some vehicle parking. Construction will also include the installation of a stormwater system and subsurface utilities.

Due to the relatively flat topography, it is anticipated that earthwork cuts and fills will be less than one foot to achieve the desired design grade. The convenience store will be constructed with a metal or wood frame and a slab on grade floor.

Structural design loads were not available at the time this report was written. However, based on our experience with similar projects, we anticipate that wall and column loads will be approximately seven hundred and fifty (750) to one thousand five hundred (1500) pounds per lineal foot (maximum dead plus live loads). Slab on grade loads will most likely range from one hundred (100) to one hundred and fifty (150) pounds per square foot (psf).

If any of the above information is incorrect or changes, we should be consulted to review the recommendations contained in this report. In any case, it is recommended that Earth Engineering, Inc. perform a general review of the final design for the proposed construction.

SITE CONDITIONS

Surface

The irregular shaped property encompasses approximately seven tenths of an acre. No structures were observed on site during the time of our fieldwork (March 2022). The adjacent properties to the north and south have been developed with restaurants. The site is bordered to the east by an Interstate Highway (I-5) off ramp and to the west by Boones Ferry Road.

The property slopes gently downward from the northeast to the southwest with an overall elevation change of four feet and a gradient of about two percent (2%). The property is covered predominantly with mowed grass with some low bushes along the eastern property line.

Subsurface & Soil Classification

For this study, the site was explored by excavating three test pits at the approximate locations shown on the *Site Plan, Figure 2*. Infiltration testing was performed in one of the test pits. All soil was classified following the Unified Soil Classification System (USCS). A USCS Legend is included as Plate A1. A description of the field exploration methods is included in Appendix A.

In general, in our test pits we encountered native soil consisting of lean Clay (CL) with some gravel and cobbles to the maximum exploration depth of eleven (11) feet below the existing ground surface. Please refer to the test pit logs, Plates A-2 thru A-4, for a more detailed description of the conditions encountered.

Groundwater

During the time of our field exploration (March 2022) groundwater was not encountered in any of our test pits. It is important to note that groundwater conditions are not static; fluctuations may be expected in the level and seepage flow depending on the season, amount of rainfall, surface water runoff, and other factors. Generally, groundwater levels are higher and the seepage rate is greater in the wetter winter months (typically October through May).

General Regional Geology

General information about geologic conditions and soil in the vicinity of the site was obtained by reviewing the USGS & Oregon Water Resources Dept. Geologic Map - Quaternary Geologic Units in Willamette Valley, Oregon (1620, Dated 2001). This map provides general information about geologic units in the Wilsonville, Clackamas County, Oregon area.

Our review of existing geological information indicates that soils in the vicinity of the subject site were formed from alluvial deposits during the Quaternary Period. Outburst flood deposits from glacial Lake Missoula deposited these sedimentary soils. The material encountered in our test pits consists predominantly of native lean clay with some gravel and cobbles.

LABORATORY TESTING

Laboratory tests were conducted on representative soil samples to verify or modify the field soil classification of the units encountered, and to evaluate the general physical properties as well as the engineering characteristics of the soils encountered. The following provides information about the testing procedures performed on representative soil samples and the general condition of subsurface soil conditions encountered:

- *Moisture Content (ASTM-D2216-92)* tests were performed on representative samples. The native lean Clay has a moisture content that ranges from twenty-two to twenty-nine percent (22-29 %).

- In-Situ Soil Density (ASTM-D4564-93) utilizing the sleeve method was performed on representative samples to determine the wet and dry density of native soil. The in-situ density provides a relative indication of soil support characteristics. The average wet density of the native lean clay is one hundred and thirteen and one-half (113.5) pounds per cubic foot (pcf). The average dry density of this soil is ninety three and one-half (93.5) pcf.
- Atterberg Limits (ASTM-D4318-95) were performed on representative samples to determine the “water-plasticity” ratio of in-situ soil. This test also provides an indication of relative soil strength as well as the potential for soil volume changes with variation in moisture content. The lean Clay encountered on our test pits has an average liquid limit of thirty-five (35) and a plasticity index of seventeen (17).

Laboratory testing confirms that subsurface soil consists predominantly of lean Clay. This type of soil is sensitive to changes in moisture content. Moisture sensitive soils are discussed in more detail in the *Site Preparation and Grading* section of this report.

The results of laboratory tests performed on specific samples are provided at the appropriate sample depth on the individual test pit logs. However, it is important to note that some variation of subsurface conditions may exist. Our geotechnical recommendations are based on our interpretation of these test results.

SEISMIC HAZARD EVALUATION

The following provides a seismic hazard evaluation for the subject site. Our evaluation is based on subsurface conditions encountered at the site during the time of our geotechnical study and a review of applicable geologic maps (USGS & Oregon Water Resources Dept. Geologic Map - Quaternary Geologic Units in Willamette Valley, Oregon 2001) and the International Building Code (IBC-2015) guidelines.

In general, supportive soil at the subject site consists of stiff lean Clay. The referenced Geologic map indicates that no known active faults are located within one-mile of the subject site. Soil encountered at the site are classified as a type “D” soil in accordance with “Seismic Design Categories” (IBC 2015, Section 1805.5.12). For more detail regarding soil conditions refer to the test pit logs in Appendix A of this report.

Liquefaction:

Structures are subject to damage from earthquakes due to direct and indirect action. Shaking represents direct action. Indirect action is represented by foundation failures and is typified by liquefaction. Liquefaction occurs when soil loses all shear strength for short periods of time during an earthquake. Ground shaking of sufficient duration results in the loss of grain to grain contact as well as a rapid increase in pore water pressure. This causes the soil to assume physical properties of a fluid.

To have potential for liquefaction a soil must be loose, cohesion-less (generally sands and silts), below the groundwater table, and must be subjected to sufficient magnitude and duration of ground shaking. The effects of liquefaction may be large total settlement and/or large differential settlement for structures with foundations in or above the liquefied soil.

Based on the stiff soil conditions encountered and the absence of a near surface groundwater table, it is not likely that soil liquefaction would occur at the subject site during a seismic event.

DISCUSSION AND RECOMMENDATIONS

General

Based on the results of our study, it is our opinion the residential subdivision can be developed as planned provided the geotechnical recommendations contained in this report are incorporated into the final design. The proposed buildings can be supported on conventional shallow spread footings bearing either entirely on competent native soil or compacted structural fill. Supporting the proposed buildings on homogeneous material will significantly decrease the potential for differential settlement across the foundation area.

This report has been prepared for specific application to this project only and in a manner consistent with that level of care and skill ordinarily exercised by other members of the profession currently practicing under similar conditions in this area for the exclusive use of Laz Ayala and their representatives. This report, in its entirety, should be included in the project documents for information to the contractor. No warranty, expressed or implied, is made.

Site Preparation and Grading

The site shall be stripped and cleared of all vegetation, organic matter and any other deleterious material. Stripped material should not be mixed with any soils to be used as fill. Stripped soil could potentially be used for topsoil at landscape areas after removing vegetation and screening out organic matter.

Building & Driveway Areas:

After clearing and grading, the exposed sub-grade at building and pavement areas should be compacted to a dense non-yielding condition with suitable compaction equipment. This phase of earthwork compaction shall be performed prior to the placement of structural fill, at the bottom of all foundation excavations, interior and exterior concrete slabs, as well as the driveway-parking area, before the placement of base rock.

Structural Fill:

Structural fill is defined as any soil placed under buildings or any other load bearing-areas. Structural fill placed under footings and slab on grade should be placed in thin horizontal lifts not exceeding eight inches and compacted to a minimum ninety-five percent (95%) of its maximum dry density (Modified Proctor ASTM D1557). The fill material should be placed within two to three percent of the optimum moisture content.

Fill under pavements should also be placed in lifts approximately eight inches in thickness, and compacted to a minimum of ninety percent (92%) of its maximum dry density (Modified Proctor ASTM D1598), except for the top twelve (12) inches which should be compacted to ninety-five percent (95%) of the maximum dry density.

We recommend that structural fill consist of a well graded granular material having a maximum size of two inches and no more than five percent (5%) fines passing the #200 sieve, based on the $\frac{3}{4}$ inch fraction. It is recommended that any structural fill planned for onsite use, be submitted for approval prior to import.

The placement and compaction of structural fill should be observed by a representative from our office to verify that fill has been placed and compacted in accordance with the approved project plans and specifications.

It should be noted that the depth of excavation to competent soil at foundation footings and floor slab areas could be greater or less than anticipated depending on conditions encountered. Our test pits provide general information about subsurface soil and groundwater conditions.

Wet Weather Construction & Moisture Sensitive Soils:

Field observations and laboratory testing indicates that soil encountered at the site consists of moisture sensitive lean Clay. As such in an exposed condition moisture sensitive soil can become disturbed during normal construction activity, especially when in a wet or saturated condition. Once disturbed, in a wet condition, these soils will be unsuitable for support of foundations, floor slabs and pavements.

Therefore, where soil is exposed and will support new construction, care must be taken not to disturb their condition. If disturbed soil conditions develop, the affected soil must be removed and replaced with structural fill. The depth of removal will be dependent on the depth of disturbance developed during construction. Covering the excavated area with plastic and refraining from excavation activities during rainfall will minimize the disturbance and decrease the potential degradation of supportive soils.

Earthwork grading and foundation construction will be difficult during the wet winter and spring seasons. Based on this condition we suggest that grading and foundation construction be completed during the drier summer and fall seasons.

Foundations

Based on the encountered subsurface soil conditions, preliminary building design criteria, and assuming compliance with the preceding *Site Preparation and Grading* section, the proposed building may be supported on conventional shallow spread footings bearing entirely on six inches of compacted granular structural fill.

Individual spread footings or continuous wall footings providing support for the proposed commercial building and pump island canopy may be designed for a maximum allowable bearing value of one-thousand five-hundred (1500) pounds per square foot (psf).

Footings for a one level structure should be at least twelve (12) inches in width. Footings for a two-level structure should be a minimum of fifteen (15) inches in width. In either case, all footings should extend to a depth of at least eighteen (18) inches below the lowest adjacent finished sub grade for lateral support and frost heave considerations.

These basic allowable bearing values are for dead plus live loads and may be increased one-third for combined dead, live, wind, and seismic forces. It is estimated that total and differential footing settlements for the relatively light building will be approximately one-half and one-quarter inches, respectively.

Lateral loads can be resisted by friction between the foundation and the supporting sub grade or by passive earth pressure acting on the buried portions of the foundation. For the latter, the foundations must be poured "neat" against the existing soil or back filled with a compacted fill meeting the requirements of structural fill.

- Passive Pressure = 300 pcf equivalent fluid weight
- Coefficient of Friction = 0.40

We recommend that all footing excavations be observed by a representative of Earth Engineering, Inc. prior to placing forms or rebar, to verify that sub grade support conditions are as anticipated in this report, and/or provide modifications in the design as required.

Slab on Grade

The sub-grade for all concrete floor slab areas should be compacted to a dense non-yielding condition prior to the placement of base rock. It is important to note that the existing sub-grade soil may become too wet to re-compact due to weather conditions. If supportive soils become saturated it may be necessary to remove the unsuitable material and replace it with imported granular structural fill.

Interior floor slabs should be provided with a minimum of eight inches of compacted granular structural fill after compacting the sub-grade. In areas where moisture is undesirable, a vapor barrier such as a 8-mil plastic membrane should be placed beneath the slab.

Temporary Excavations

The following information is provided solely as a service to our client. Under no circumstances should this information be interpreted to mean that Earth Engineering Inc. is assuming responsibility for construction site safety or the contractor's activities; such responsibility is not being implied and should not be inferred.

In no case should excavation slopes be greater than the limits specified in local, state and federal safety regulations. Based on the information obtained from our field exploration and laboratory testing, the site soils expected to be encountered in excavations, stiff lean Clay would be classified as a Type "A" soil by OSHA guidelines.

Therefore, temporary excavations and cuts greater than four feet in height, should be sloped at an inclination no steeper than 3/4H:1V (horizontal:vertical) for type "A" soils. If slopes of this inclination, or flatter, cannot be constructed or if excavations greater than ten feet in depth are required, temporary shoring will be necessary.

Infiltration Testing

During March of 2022, infiltration testing was performed at one location at a depth of three feet below the existing ground surface. The approximate location of the infiltration test is shown on the *Site Plan, Figure 2*.

Infiltration testing was conducted in general accordance with standard engineering practices. The Encased Falling Head Test consists of driving a fifteen (15) inch long, six-inch diameter pipe six inches into the exposed ground surface at the bottom of the test pit. The pipe is filled with water as the soil around the bottom and below the pipe is saturated for several hours. The pipe is filled again, and the amount of time required for the water to fall, per inch, for six inches, is recorded. This step is performed a minimum of three times. The test results are averaged and calculated in inches per hour. The following table provides the infiltration test results, soil classification and a summary of laboratory test results for soil encountered at the depth of proposed infiltration:

LOCATION	*USCS SOIL TYPE	AASHTO SOIL TYPE	DEPTH (FT.)	MOISTURE CONTENT %	% PASSING # 200 SIEVE	FIELD INFILTRATION RATE
I-1	CL	A-6	4.0	25	N/A	4 iph

It is important to note that this provides a relative indication of the average rate of groundwater infiltration at the site. The rate is dependent on the percentage of fines in the soil (i.e., silt and clay), the degree of soil saturation and the relative density of the in-situ soil. Infiltration rates can vary across the site depending on conditions encountered.

Site Drainage

The site should be graded so that surface water is directed off the site. Water should not be allowed to stand in any area where buildings or slabs are to be constructed. Loose surfaces should be sealed at the end of each workday by compacting the surface to reduce the potential for moisture infiltration into the soils. Final site grades should allow for drainage away from the building foundation. The ground should be sloped at a gradient of three percent for a distance of at least ten feet away from the buildings.

We recommend that a footing drain be installed around the perimeter of the buildings just below the invert of the footing with a gradient sufficient to initiate flow. Under no circumstances should the roof down spouts be connected to the footing drain system. We suggest that clean outs be installed at several accessible locations to allow for the periodic maintenance of the footing drain system. Details for the footing drain have been included on *Figure 3, Typical Footing Drain Detail*.

Utility Support and Back Fill

Based on the conditions encountered, the soil to be exposed by utility trenches should provide adequate support for utilities. Utility trench backfill is a concern in reducing the potential for settlement along utility alignments, particularly in pavement areas. It is also important that each section of utility line be adequately supported in the bedding material. The back fill material should be hand tamped to ensure support is provided around the pipe haunches.

Fill should be carefully placed and hand tamped to about twelve inches above the crown of the pipe before any compaction equipment is used. The remainder of the trench back fill should be placed in lifts having a loose thickness of eight inches.

A typical trench backfill section and compaction requirements for load supporting and non-load supporting areas is presented on *Figure 4, Utility Trench Backfill Detail*. Trench back fill may consist of imported granular fill provided the material is approved, placed and compacted near the optimum moisture content.

Imported granular material or on-site soil to be used as backfill should be submitted to our laboratory at least one week prior to construction so that we can provide a laboratory proctor for field density testing. If native soil is planned for use as backfill, additional testing may be required to determine the suitability of the material.

Pavements

The durability of pavements is related in part to the condition of the underlying sub grade. To provide a properly prepared sub grade for pavements, we recommend the sub grade be treated and prepared as described in the *Site Preparation and Grading* section of this report.

It is possible that some localized areas of soft, wet or unstable sub grade may still exist after this process. Before placement of any base rock, the sub grade should be compacted with suitable compaction equipment. Yielding areas that are identified should be excavated to firm material and replaced with compacted one and one quarter inch-minus clean-crushed rock. The following pavement sections are recommended for the proposed pavement areas:

- Entrance Driveway & Truck Turnaround - Four inches of Asphalt Concrete (AC) over ten inches of compacted Crushed Rock Base (CRB), over a geo-grid consisting of Tensar Triax or equivalent.
- Parking Stalls for Automobiles - Three inches of Asphalt Concrete (AC) over eight inches of compacted Crushed Rock Base (CRB) material.

The geo-grid should be placed directly on the sub grade surface of the driveway prior to placement of base rock. Appropriate geo-textiles have been designed to increase the strength of the sub grade and extend pavement life.

Asphaltic Cement (AC) and Crushed Rock Base (CRB) materials should conform to ODOT specifications. All base rock should be compacted to at least ninety-five percent (95 %) of the ASTM D1557-91 laboratory test standard.

We recommend that a minimum of eight inches of compacted CRB be placed below all exterior slabs. Exterior concrete slabs that are subject to vehicle traffic loads should be at five inches in thickness. It is also suggested that nominal reinforcement such as "6x6-10/10" welded wire mesh be installed, near midpoint, in new exterior concrete slabs and paving. Fiber mesh concrete may be used in lieu of welded wire mesh.

Additional Services & Earthwork Monitoring

Earth Engineering, Inc. will be available to provide consultation services related to review of the final design to verify that the recommendations within our purview have been properly interpreted and implemented in the approved construction plans and specifications. A representative from our office will be available to attend a pre-construction meeting to discuss and/or clarify all geotechnical issues related to the proposed project.

In addition, it is suggested that our office be retained to provide geotechnical services during construction to observe compliance with the design concepts and project specifications and to allow design changes in the event subsurface conditions differ from those anticipated. Our construction services would include monitoring and documenting the following:

- Verify that site has been adequately stripped of organic materials.
- Observe the condition of exposed bearing soils at the building area.
- Laboratory proctor tests for structural fill materials.
- Observe compaction and provide density testing of structural fill.
- Observe compaction and provide density testing of utility trench backfill.
- Provide footing inspection at building to verify soil bearing capacity.
- Verify the installation of all building and site drainage elements.

LIMITATIONS

Our recommendations and conclusions are based on the site materials observed, selective laboratory testing, engineering analyses, the design information provided to Earth Engineering, Inc. and our experience as well as engineering judgment. The conclusions and recommendations are professional opinions derived in a manner consistent with that level of care and skill ordinarily exercised by other members of the profession currently practicing under similar conditions in this area. No warranty is expressed or implied.

The recommendations submitted in this report are based upon the data obtained from the test pits. Soil and groundwater conditions may vary from those encountered. The nature and extent of variations may not become evident until construction. If variations do appear, Earth Engineering, Inc. should be requested to reevaluate the recommendations contained in this report and to modify or verify them in writing prior to proceeding with the proposed construction.

VICINITY MAP



Earth Engineering
GEOTECHNICAL & ENVIRONMENTAL SERVICES

CLIENT: LAZ AYALA
PROJECT: WILSONVILLE CONVENIENCE STORE
29760 BOONES FERRY ROAD
WILSONVILLE, OR

DRAWN: CCK
DATE: 4/2022
FIGURE: 2
PRO. #: G14-0322

SITE PLAN

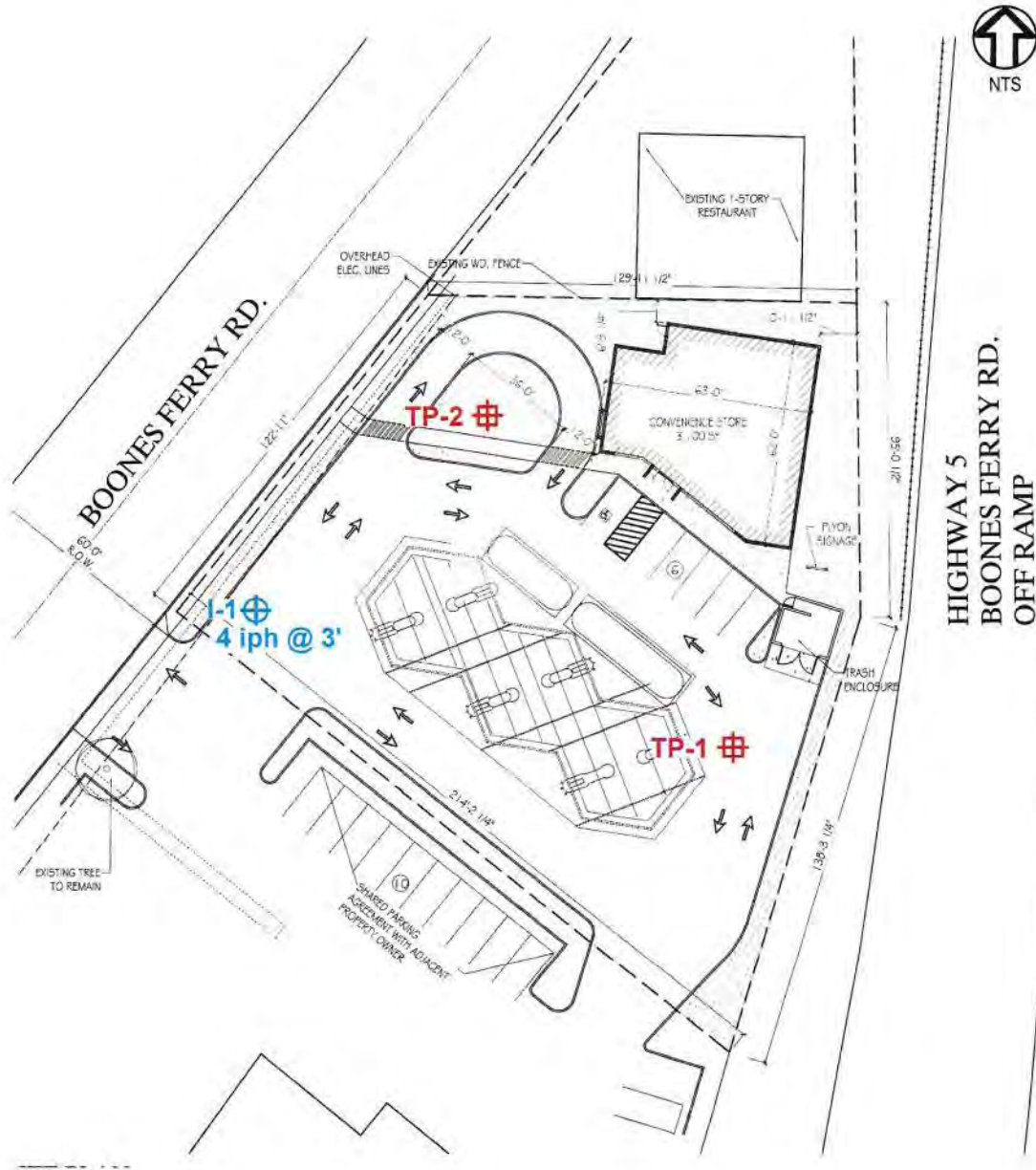

HIGHWAY 5
 BOONES FERRY RD.
 OFF RAMP

LEGEND

- ⊕ TP-1 ⊕ Approximate Location of Test Pits
- ⊕ I-1 ⊕ Approximate Location of Infiltration Test Pit



CLIENT: LAZ AYALA	DRAWN: CCK
PROJECT: WILSONVILLE CONVENIENCE STORE 29760 BOONES FERRY ROAD WILSONVILLE, OR	DATE: 4/2022
	FIGURE: 2
	PRO. #: G14-0322

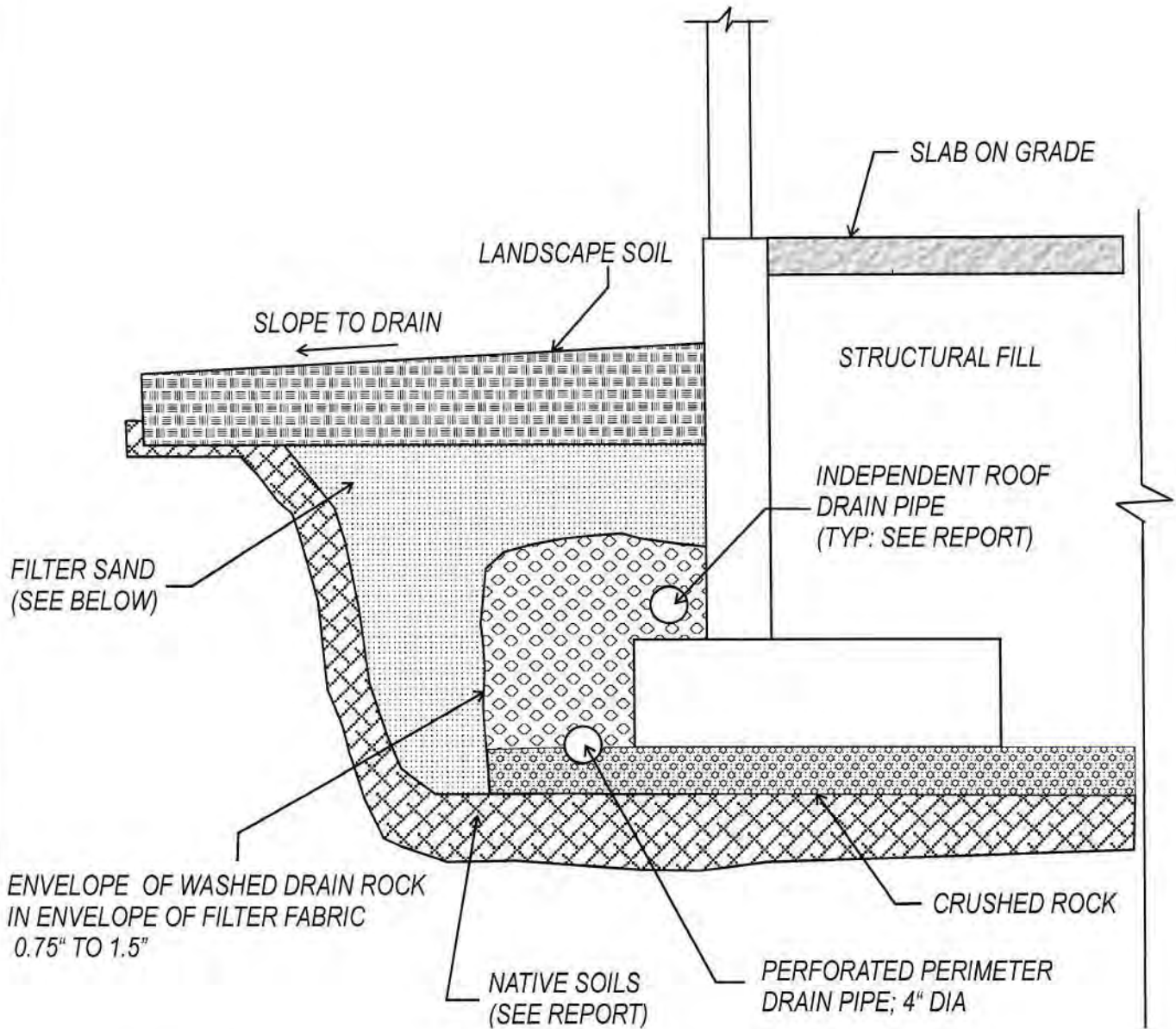

NOTES:

1. FILTER SAND - FINE AGGREGATE FOR PORTLAND CEMENT; SECTION 9-03.1(2)
2. PERFORATED OR SLOTTED RIGID PVC PIPE WITH A POSITIVE DRAINAGE GRADIENT
3. FILTER FABRIC OPTIONAL IF FILTER SAND USED

TYPICAL FOOTING DRAIN DETAIL

Not to Scale

 <p>Earth Engineering, Inc. GEOTECHNICAL & ENVIRONMENTAL SERVICES</p>	CLIENT: AYALA	DRAWN: EG
	PROJECT: WILSONVILLE CONVENIENCE STORE 29760 BOONES FERRY ROAD WILSONVILLE, OR	DATE: 04/2022
		FIGURE: 3
		PRO. #: G14-0322

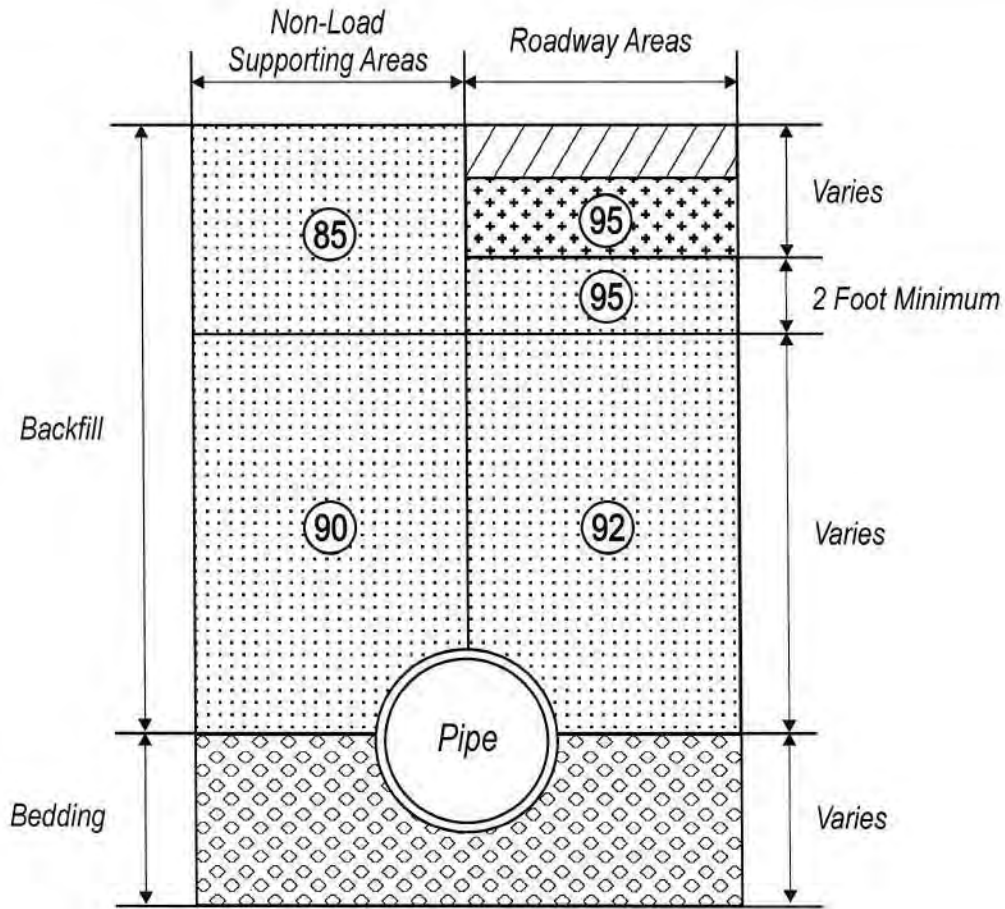

LEGEND



Asphalt or Concrete Pavement



Roadway Base Material or Base Rock



Backfill: Compacted on-site soil or imported select fill material as described in the site preparation of the general Earthwork Section of the attached report text.



Minimum percentage of maximum Laboratory Dry Density as determined by ASTM Test method D1557 (Modified Proctor), unless otherwise specified in the attached report text.

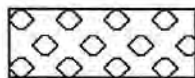

Bedding Material: Material type depends on type of pipe and laying conditions. Bedding should conform to the manufacturer's recommendations for the type of pipe selected.

UTILITY TRENCH BACKFILL DETAIL

Not to Scale



Earth Engineering, Inc.

GEOTECHNICAL & ENVIRONMENTAL CONSULTANTS

CLIENT:	AYALA	DRAWN:	EG
PROJECT:	WILSONVILLE CONVENIENCE STORE 29760 BOONES FERRY ROAD WILSONVILLE, OR	DATE:	04/2022
		FIGURE:	4
		PRO. #:	G14-0322

APPENDIX A

(FIELD EXPLORATION)

FIELD EXPLORATION

Our field exploration was performed on March 11th 2022. Subsurface conditions at the site were explored by excavating three test pits. The test pits were excavated to a maximum depth of eleven (11) feet below the existing ground surface. The test pits were excavated using a track-hoe.

The test pits were located by pacing from property features. The locations are shown on the Site Plan, Figure 2. Field exploration was monitored by an Earth Engineering, Inc. representative, who classified the soils that we encountered and maintained a log of each test pit, obtained representative samples, and observed pertinent site features. Representative soil samples were placed in closed containers and returned to the laboratory for further examination and testing.

All samples were identified using the Standard Classification of Soils for Engineering Purposes (ASTM D2487-93) in accordance with the Unified Soil Classification System (USCS), which is presented on Plate A-1. The test pit log and boring logs are presented in Appendix A. The final log represents our interpretations of the field logs and the results of the laboratory tests on field samples.

UNIFIED SOIL CLASSIFICATION SYSTEM LEGEND

MAJOR DIVISIONS			GRAPH SYMBOL	LETTER SYMBOL	TYPICAL DESCRIPTION
Coarse Grained Soils	Gravel and Gravelly Soils More Than 50% Coarse Fraction Retained on No 4 Sieve	Clean Gravels (little or no fines)		GW gw	Well-Graded Gravels, Gravel-Sand Mixtures Little or no Fines
		Gravels with Fines (appreciable amount of fines)		GP gp	Poorly-Graded Gravels, Gravel-Sand Mixtures, Little or no Fines
	Sand and Sandy Soils More Than 50% Coarse Fraction Passing No 4 Sieve	Clean Sand (little or no fines)		GM gm	Silty Gravels, Gravel-Sand-Silt Mixtures
		Sands with Fines (appreciable amount of fines)		GC gc	Clayey Gravels, Gravel-Sand-Clay Mixtures
More Than 50% Material Larger Than No 200 Sieve Size	Sand and Sandy Soils More Than 50% Coarse Fraction Passing No 4 Sieve	Clean Sand (little or no fines)		SW sw	Well-graded Sands, Gravelly Sands Little or no Fines
		Sands with Fines (appreciable amount of fines)		SP sp	Poorly-Graded Sands, Gravelly Sands Little or no Fines
	Sands with Fines (appreciable amount of fines)	Sands with Fines (appreciable amount of fines)		SM sm	Silty Sands, Sand-Silt Mixtures
		Sands with Fines (appreciable amount of fines)		SC sc	Clayey Sands, Sand-Clay Mixtures
Fine Grained Soils	Sils and Clays	Liquid Limit Less than 50		ML ml	Inorganic Silts and Very Fine Sands, Rock Flour, Silty-Clayey Fine Sands; Clayey Silts w/ slight Plasticity
				CL cl	Inorganic Clays of Low to Medium Plasticity, Gravelly Clays, Sandy Clays, Silty Clays, Lean
				OL ol	Organic Silts and Organic Silty Clays of Low Plasticity
	Sils and Clays	Liquid Limit Greater than 50		MH mh	Inorganic Silts, Micaceous or Diatomaceous Fine Sand or Silty Soils
				CH ch	Inorganic Clays of High Plasticity, Fat Clays
				OH oh	Organic Clays of Medium to High Plasticity, Organic Silts
Highly Organic Soils				PT pt	Peat, Humus, Swamp Soils with High Organic Contents

Topsoil		Humus and Duff Layer
Fill		Highly Variable Constituents



Earth Engineering Inc.

GEOTECHNICAL & ENVIRONMENTAL SERVICES

CLIENT:	AYALA	DRAWN:	EG
PROJECT:	WILSONVILLE CONVENIENCE STORE 29760 BOONES FERRY ROAD WILSONVILLE, OR	DATE:	04/2022
		PLATE:	A1
		PRO. #:	G14-0322

LOG OF TEST PIT (West)

I-1

ELEVATION: +/- 160.5 feet
 EXPLORATORY EQUIPMENT: TRACK HOE
 DATE: 03/11/2022

DEPTH IN FEET	SAMPLES	SOILS CLASSIFICATION	LITHOLOGY (USGS)	COLOR	MOISTURE	CONSISTENCY	MOISTURE CONTENT % OF DRY WEIGHT	PERCENT PASS NUMBER 200
1	•	6" Topsoil					24	-
2								
3		Field infiltration rate - 4 inches per hour						
4	•	lean Clay (CL)		Dark Brown	Moist	Firm to Stiff	26	-
5								
6								
7	•	(Native)					23	-
8								

Bottom of test pit at 8.0 feet below existing ground surface.
 No groundwater was encountered.



Earth Engineering, Inc.
 GEOTECHNICAL & ENVIRONMENTAL SERVICES

CLIENT:	AYALA	DRAWN:	EG
PROJECT:	WILSONVILLE CONVENIENCE STORE 29760 BOONES FERRY ROAD WILSONVILLE, OR	DATE:	04/2022
		PLATE:	A2
		PRO. #:	CM14-0322

LOG OF TEST PIT
(Northwest)

TP-1

ELEVATION: +/- 164 feet
EXPLORATORY EQUIPMENT: TRACK HOE
DATE: 03/11/2022

DEPTH IN FEET	SAMPLES	SOILS CLASSIFICATION	LITHOLOGY (USGS)	COLOR	MOISTURE	CONSISTENCY	MOISTURE CONTENT % OF DRY WEIGHT	PERCENT PASS NUMBER 200
1		4" Topsoil						
1.5	X	Wet γ ~113 pcf Dry γ ~93 pcf Liquid Limit - 38 Plastic Index -19						
2		lean Clay (CL)		Dark Brown	Moist	Firm to Stiff	22	-
3		{gravel & cobbles}						
4		(Native)						
5								

Bottom of test pit at 5.0 feet below existing ground surface.
No groundwater was encountered.



Earth Engineering, Inc.

GEOTECHNICAL & ENVIRONMENTAL SERVICES

CLIENT:	AYALA	DRAWN:	EG
PROJECT:	WILSONVILLE CONVENIENCE STORE 29760 BOONES FERRY ROAD WILSONVILLE, OR	DATE:	04/2022
		PLATE:	A3
		PRO. #:	CM14-0322

LOG OF TEST PIT
(Northwest)

TP-2

ELEVATION: +/- 163 feet

EXPLORATORY EQUIPMENT: TRACK HOE

DATE: 03/11/2022

DEPTH IN FEET	SAMPLES	SOILS CLASSIFICATION	LITHOLOGY (USGS)	COLOR	MOISTURE	CONSISTENCY	MOISTURE CONTENT % OF DRY WEIGHT	PERCENT PASS NUMBER 200
1		6" Topsoil						
2	⊗	Wet γ ~114 pcf Dry γ ~94 pcf Liquid Limit - 32 Plastic Index - 15				Firm to Stiff	22	-
3								
4		{gravel & cobbles}						
5		lean Clay (CL)						
6	●			Dark Brown	Moist		29	-
7								
8						Very Stiff to Hard		
9								
10								
11		(Native)						

Bottom of test pit at 11.0 feet below existing ground surface.
No groundwater was encountered.



Earth Engineering, Inc.

GEOTECHNICAL & ENVIRONMENTAL SERVICES

CLIENT: AYALA

DRAWN: EG

PROJECT: WILSONVILLE
CONVENIENCE STORE
29760 BOONES FERRY ROAD
WILSONVILLE, OR

DATE: 04/2022

PLATE: A4

PRO. #: CM14-0322

APPENDIX B
(LABORATORY TESTING)

ATTERBERG LIMITS ASTM D4318-95

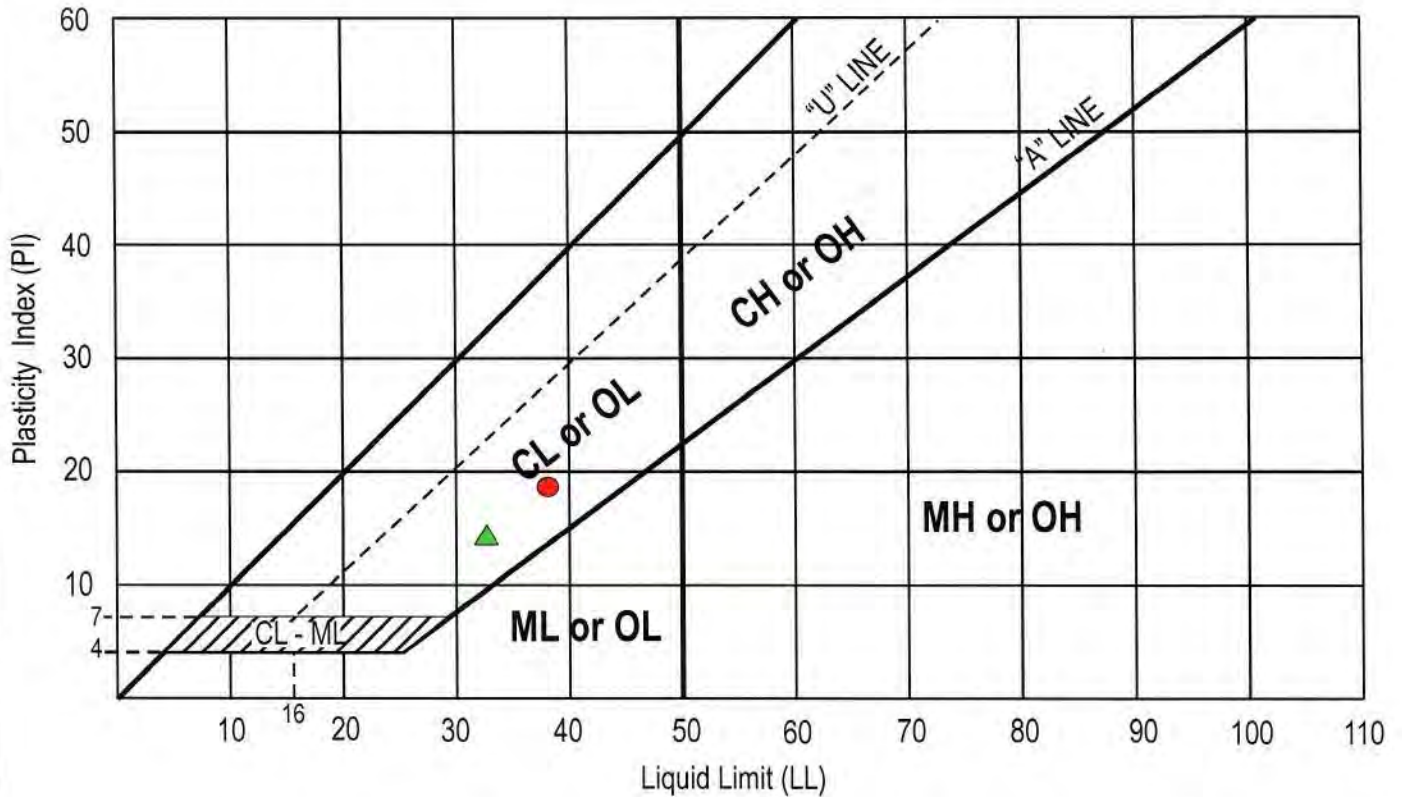

● TP-1 @ 2.0 feet bgs - lean Clay (CL)
Liquid Limit = 38 Plasticity Index = 19

▲ TP-2 @ 1.5 feet bgs - lean Clay (CL)
Liquid Limit = 32 Plasticity Index = 15



Earth Engineering, Inc.

GEOTECHNICAL & ENVIRONMENTAL SERVICES

CLIENT:	AYALA	DRAWN:	EG
PROJECT:	WILSONVILLE CONVENIENCE STORE 29760 BOONES FERRY ROAD WILSONVILLE, OR	DATE:	04/2022
		PLATE:	B1
		PRO. #:	G14-0322

DISTRIBUTION

{G14-0322}

1 Copy

PLS Engineering
604 W. Evergreen Blvd.
Vancouver, Washington 98660

Attention: Andrew Gunther

1 Copy

Laz Ayala
132 West Main Street
Medford, Oregon 97501

GEOTECHNICAL ENGINEERING STUDY

Wilsonville Convenience Store
29760 Boones Ferry Road
Wilsonville, Clackamas County, Oregon 97070
Tax Lot No. (31W14D01002)

Prepared for:
Laz Ayala
132 West Main Street
Medford, Oregon 997501

Prepared By:

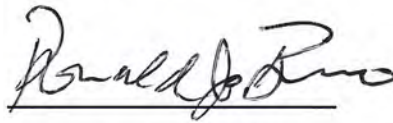

Donald J. Bruno, CEG
Engineering Geologist

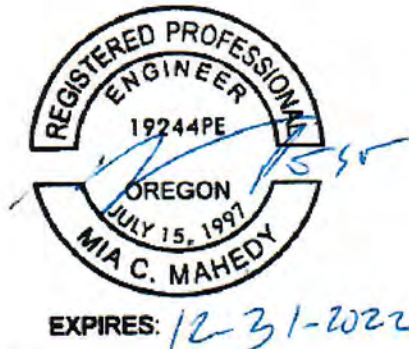

Mia Mahedy, PE,GE
Project Engineer

Project No. G14-0322

{April 2022}

Earth Engineering Inc.
PO Box 1512, Ridgefield, Washington 98642
(360) 600-6518

Earth Engineering, Inc.

Geotechnical & Environmental Consultants

Laz Ayala
132 West Main Street
Medford, Oregon 97501

April 22, 2022
G14-0322

Subject: Geotechnical Engineering Study
Wilsonville Convenience Store
29760 Boones Ferry Road, Wilsonville, Clackamas County, Oregon
(Tax Lot No. 31W14D01002)

Hello Laz,

We are pleased to submit our engineering report for the subject property located in Wilsonville, Oregon. This report presents the results of our field exploration, selective laboratory tests, field testing and engineering analyses.

Based on the results of this study, it is our opinion that construction of the proposed commercial structure is feasible from a geotechnical standpoint, provided recommendations presented in this report are included in the project design.

We appreciate the opportunity to have been of service to you and look forward to working with you in the future. Should you have any questions about the content of this report, or if we can be of further assistance, please call.

Respectfully Submitted,
Earth Engineering Inc.,

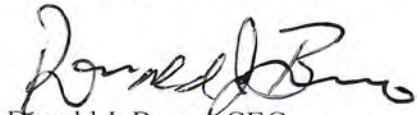

Donald J. Bruno, CEG
Engineering Geologist

TABLE OF CONTENTS

{G14-0322}

<u>INTRODUCTION</u>	1
General	1
Project Description	1
<u>SITE CONDITIONS</u>	1-2
Surface	1
Subsurface	2
Groundwater	2
General Regional Geology	2
<u>LABORATORY TESTING</u>	2-3
<u>SEISMIC HAZARD EVALUATION</u>	3-4
<u>DISCUSSION AND RECOMMENDATIONS</u>	4
General	4
Site Preparation & Grading	4-5
Foundations	5-6
Slab on Grade	6
Temporary Excavations	6-7
Infiltration Testing	7
Site Drainage	7
Utility Support & Back Fill	8
Pavements	8-9
Additional Services	9
<u>LIMITATIONS</u>	10

GRAPHICS

Figure 1	Vicinity Map
Figure 2	Site Plan (Test Pit & Infiltration Locations)
Figure 3	Typical Footing Drain Detail
Figure 4	Typical Utility Trench Back Fill Detail

APPENDICES

Appendix A	Field Exploration
Plate A1	Unified Soil Classification- Legend
Plates A2-A4	Log of Exploratory Test Pits
Appendix B	Field Exploration
Plate B1	Atterberg Limits

INTRODUCTION

General

This report presents the results of the geotechnical engineering study completed by Earth Engineering, Inc. for the proposed convenience store and fuel pumping facility located in Wilsonville, Clackamas County, Oregon. The general location of the site is shown on the *Vicinity Map, Figure 1*. At the time our study was performed, the site and our exploratory locations are approximately as shown on the *Site Plan, Figure 2*.

The purpose of this study was to explore subsurface conditions at the site and based on the conditions encountered provide geotechnical recommendations for the proposed construction. In addition this report includes infiltration testing for stormwater design and a seismic hazard evaluation.

Project Description

Based on the information that was provided to us by Oregon Architecture and the project civil engineer (PLS), it is our understanding the site will be developed with a one story building that will provide three- thousand one-hundred (3100) square feet of floor space, a pumping island, a trash enclosure, and an asphalt paved access driveway with some vehicle parking. Construction will also include the installation of a stormwater system and subsurface utilities.

Due to the relatively flat topography, it is anticipated that earthwork cuts and fills will be less than one foot to achieve the desired design grade. The convenience store will be constructed with a metal or wood frame and a slab on grade floor.

Structural design loads were not available at the time this report was written. However, based on our experience with similar projects, we anticipate that wall and column loads will be approximately seven hundred and fifty (750) to one thousand five hundred (1500) pounds per lineal foot (maximum dead plus live loads). Slab on grade loads will most likely range from one hundred (100) to one hundred and fifty (150) pounds per square foot (psf).

If any of the above information is incorrect or changes, we should be consulted to review the recommendations contained in this report. In any case, it is recommended that Earth Engineering, Inc. perform a general review of the final design for the proposed construction.

SITE CONDITIONS

Surface

The irregular shaped property encompasses approximately seven tenths of an acre. No structures were observed on site during the time of our fieldwork (March 2022). The adjacent properties to the north and south have been developed with restaurants. The site is bordered to the east by an Interstate Highway (I-5) off ramp and to the west by Boones Ferry Road.

The property slopes gently downward from the northeast to the southwest with an overall elevation change of four feet and a gradient of about two percent (2%). The property is covered predominantly with mowed grass with some low bushes along the eastern property line.

Subsurface & Soil Classification

For this study, the site was explored by excavating three test pits at the approximate locations shown on the *Site Plan, Figure 2*. Infiltration testing was performed in one of the test pits. All soil was classified following the Unified Soil Classification System (USCS). A USCS Legend is included as Plate A1. A description of the field exploration methods is included in Appendix A.

In general, in our test pits we encountered native soil consisting of lean Clay (CL) with some gravel and cobbles to the maximum exploration depth of eleven (11) feet below the existing ground surface. Please refer to the test pit logs, Plates A-2 thru A-4, for a more detailed description of the conditions encountered.

Groundwater

During the time of our field exploration (March 2022) groundwater was not encountered in any of our test pits. It is important to note that groundwater conditions are not static; fluctuations may be expected in the level and seepage flow depending on the season, amount of rainfall, surface water runoff, and other factors. Generally, groundwater levels are higher and the seepage rate is greater in the wetter winter months (typically October through May).

General Regional Geology

General information about geologic conditions and soil in the vicinity of the site was obtained by reviewing the USGS & Oregon Water Resources Dept. Geologic Map - Quaternary Geologic Units in Willamette Valley, Oregon (1620, Dated 2001). This map provides general information about geologic units in the Wilsonville, Clackamas County, Oregon area.

Our review of existing geological information indicates that soils in the vicinity of the subject site were formed from alluvial deposits during the Quaternary Period. Outburst flood deposits from glacial Lake Missoula deposited these sedimentary soils. The material encountered in our test pits consists predominantly of native lean clay with some gravel and cobbles.

LABORATORY TESTING

Laboratory tests were conducted on representative soil samples to verify or modify the field soil classification of the units encountered, and to evaluate the general physical properties as well as the engineering characteristics of the soils encountered. The following provides information about the testing procedures performed on representative soil samples and the general condition of subsurface soil conditions encountered:

- *Moisture Content (ASTM-D2216-92)* tests were performed on representative samples. The native lean Clay has a moisture content that ranges from twenty-two to twenty-nine percent (22-29 %).

- In-Situ Soil Density (ASTM-D4564-93) utilizing the sleeve method was performed on representative samples to determine the wet and dry density of native soil. The in-situ density provides a relative indication of soil support characteristics. The average wet density of the native lean clay is one hundred and thirteen and one-half (113.5) pounds per cubic foot (pcf). The average dry density of this soil is ninety three and one-half (93.5) pcf.
- Atterberg Limits (*ASTM-D4318-95*) were performed on representative samples to determine the “water-plasticity” ratio of in-situ soil. This test also provides an indication of relative soil strength as well as the potential for soil volume changes with variation in moisture content. The lean Clay encountered on our test pits has an average liquid limit of thirty-five (35) and a plasticity index of seventeen (17).

Laboratory testing confirms that subsurface soil consists predominantly of lean Clay. This type of soil is sensitive to changes in moisture content. Moisture sensitive soils are discussed in more detail in the *Site Preparation and Grading* section of this report.

The results of laboratory tests performed on specific samples are provided at the appropriate sample depth on the individual test pit logs. However, it is important to note that some variation of subsurface conditions may exist. Our geotechnical recommendations are based on our interpretation of these test results.

SEISMIC HAZARD EVALUATION

The following provides a seismic hazard evaluation for the subject site. Our evaluation is based on subsurface conditions encountered at the site during the time of our geotechnical study and a review of applicable geologic maps (USGS & Oregon Water Resources Dept. Geologic Map - Quaternary Geologic Units in Willamette Valley, Oregon 2001) and the International Building Code (IBC-2015) guidelines.

In general, supportive soil at the subject site consists of stiff lean Clay. The referenced Geologic map indicates that no known active faults are located within one-mile of the subject site. Soil encountered at the site are classified as a type “D” soil in accordance with “Seismic Design Categories” (IBC 2015, Section 1805.5.12). For more detail regarding soil conditions refer to the test pit logs in Appendix A of this report.

Liquefaction:

Structures are subject to damage from earthquakes due to direct and indirect action. Shaking represents direct action. Indirect action is represented by foundation failures and is typified by liquefaction. Liquefaction occurs when soil loses all shear strength for short periods of time during an earthquake. Ground shaking of sufficient duration results in the loss of grain to grain contact as well as a rapid increase in pore water pressure. This causes the soil to assume physical properties of a fluid.

To have potential for liquefaction a soil must be loose, cohesion-less (generally sands and silts), below the groundwater table, and must be subjected to sufficient magnitude and duration of ground shaking. The effects of liquefaction may be large total settlement and/or large differential settlement for structures with foundations in or above the liquefied soil.

Based on the stiff soil conditions encountered and the absence of a near surface groundwater table, it is not likely that soil liquefaction would occur at the subject site during a seismic event.

DISCUSSION AND RECOMMENDATIONS

General

Based on the results of our study, it is our opinion the residential subdivision can be developed as planned provided the geotechnical recommendations contained in this report are incorporated into the final design. The proposed buildings can be supported on conventional shallow spread footings bearing either entirely on competent native soil or compacted structural fill. Supporting the proposed buildings on homogeneous material will significantly decrease the potential for differential settlement across the foundation area.

This report has been prepared for specific application to this project only and in a manner consistent with that level of care and skill ordinarily exercised by other members of the profession currently practicing under similar conditions in this area for the exclusive use of Laz Ayala and their representatives. This report, in its entirety, should be included in the project documents for information to the contractor. No warranty, expressed or implied, is made.

Site Preparation and Grading

The site shall be stripped and cleared of all vegetation, organic matter and any other deleterious material. Stripped material should not be mixed with any soils to be used as fill. Stripped soil could potentially be used for topsoil at landscape areas after removing vegetation and screening out organic matter.

Building & Driveway Areas:

After clearing and grading, the exposed sub-grade at building and pavement areas should be compacted to a dense non-yielding condition with suitable compaction equipment. This phase of earthwork compaction shall be performed prior to the placement of structural fill, at the bottom of all foundation excavations, interior and exterior concrete slabs, as well as the driveway-parking area, before the placement of base rock.

Structural Fill:

Structural fill is defined as any soil placed under buildings or any other load bearing-areas. Structural fill placed under footings and slab on grade should be placed in thin horizontal lifts not exceeding eight inches and compacted to a minimum ninety-five percent (95%) of its maximum dry density (Modified Proctor ASTM D1557). The fill material should be placed within two to three percent of the optimum moisture content.

Fill under pavements should also be placed in lifts approximately eight inches in thickness, and compacted to a minimum of ninety percent (92%) of its maximum dry density (Modified Proctor ASTM D1598), except for the top twelve (12) inches which should be compacted to ninety-five percent (95%) of the maximum dry density.

We recommend that structural fill consist of a well graded granular material having a maximum size of two inches and no more than five percent (5%) fines passing the #200 sieve, based on the ¾ inch fraction. It is recommended that any structural fill planned for onsite use, be submitted for approval prior to import.

The placement and compaction of structural fill should be observed by a representative from our office to verify that fill has been placed and compacted in accordance with the approved project plans and specifications.

It should be noted that the depth of excavation to competent soil at foundation footings and floor slab areas could be greater or less than anticipated depending on conditions encountered. Our test pits provide general information about subsurface soil and groundwater conditions.

Wet Weather Construction & Moisture Sensitive Soils:

Field observations and laboratory testing indicates that soil encountered at the site consists of moisture sensitive lean Clay. As such in an exposed condition moisture sensitive soil can become disturbed during normal construction activity, especially when in a wet or saturated condition. Once disturbed, in a wet condition, these soils will be unsuitable for support of foundations, floor slabs and pavements.

Therefore, where soil is exposed and will support new construction, care must be taken not to disturb their condition. If disturbed soil conditions develop, the affected soil must be removed and replaced with structural fill. The depth of removal will be dependent on the depth of disturbance developed during construction. Covering the excavated area with plastic and refraining from excavation activities during rainfall will minimize the disturbance and decrease the potential degradation of supportive soils.

Earthwork grading and foundation construction will be difficult during the wet winter and spring seasons. Based on this condition we suggest that grading and foundation construction be completed during the drier summer and fall seasons.

Foundations

Based on the encountered subsurface soil conditions, preliminary building design criteria, and assuming compliance with the preceding *Site Preparation and Grading* section, the proposed building may be supported on conventional shallow spread footings bearing entirely on six inches of compacted granular structural fill.

Individual spread footings or continuous wall footings providing support for the proposed commercial building and pump island canopy may be designed for a maximum allowable bearing value of one-thousand five-hundred (1500) pounds per square foot (psf).

Footings for a one level structure should be at least twelve (12) inches in width. Footings for a two-level structure should be a minimum of fifteen (15) inches in width. In either case, all footings should extend to a depth of at least eighteen (18) inches below the lowest adjacent finished sub grade for lateral support and frost heave considerations.

These basic allowable bearing values are for dead plus live loads and may be increased one-third for combined dead, live, wind, and seismic forces. It is estimated that total and differential footing settlements for the relatively light building will be approximately one-half and one-quarter inches, respectively.

Lateral loads can be resisted by friction between the foundation and the supporting sub grade or by passive earth pressure acting on the buried portions of the foundation. For the latter, the foundations must be poured "neat" against the existing soil or back filled with a compacted fill meeting the requirements of structural fill.

- Passive Pressure = 300 pcf equivalent fluid weight
- Coefficient of Friction = 0.40

We recommend that all footing excavations be observed by a representative of Earth Engineering, Inc. prior to placing forms or rebar, to verify that sub grade support conditions are as anticipated in this report, and/or provide modifications in the design as required.

Slab on Grade

The sub-grade for all concrete floor slab areas should be compacted to a dense non-yielding condition prior to the placement of base rock. It is important to note that the existing sub-grade soil may become too wet to re-compact due to weather conditions. If supportive soils become saturated it may be necessary to remove the unsuitable material and replace it with imported granular structural fill.

Interior floor slabs should be provided with a minimum of eight inches of compacted granular structural fill after compacting the sub-grade. In areas where moisture is undesirable, a vapor barrier such as a 8-mil plastic membrane should be placed beneath the slab.

Temporary Excavations

The following information is provided solely as a service to our client. Under no circumstances should this information be interpreted to mean that Earth Engineering Inc. is assuming responsibility for construction site safety or the contractor's activities; such responsibility is not being implied and should not be inferred.

In no case should excavation slopes be greater than the limits specified in local, state and federal safety regulations. Based on the information obtained from our field exploration and laboratory testing, the site soils expected to be encountered in excavations, stiff lean Clay would be classified as a Type "A" soil by OSHA guidelines.

Therefore, temporary excavations and cuts greater than four feet in height, should be sloped at an inclination no steeper than 3/4H:1V (horizontal:vertical) for type "A" soils. If slopes of this inclination, or flatter, cannot be constructed or if excavations greater than ten feet in depth are required, temporary shoring will be necessary.

Infiltration Testing

During March of 2022, infiltration testing was performed at one location at a depth of three feet below the existing ground surface. The approximate location of the infiltration test is shown on the *Site Plan, Figure 2*.

Infiltration testing was conducted in general accordance with standard engineering practices. The Encased Falling Head Test consists of driving a fifteen (15) inch long, six-inch diameter pipe six inches into the exposed ground surface at the bottom of the test pit. The pipe is filled with water as the soil around the bottom and below the pipe is saturated for several hours. The pipe is filled again, and the amount of time required for the water to fall, per inch, for six inches, is recorded. This step is performed a minimum of three times. The test results are averaged and calculated in inches per hour. The following table provides the infiltration test results, soil classification and a summary of laboratory test results for soil encountered at the depth of proposed infiltration:

LOCATION	*USCS SOIL TYPE	AASHTO SOIL TYPE	DEPTH (FT.)	MOISTURE CONTENT %	% PASSING # 200 SIEVE	FIELD INFILTRATION RATE
I-1	CL	A-6	4.0	25	N/A	4 iph

It is important to note that this provides a relative indication of the average rate of groundwater infiltration at the site. The rate is dependent on the percentage of fines in the soil (i.e., silt and clay), the degree of soil saturation and the relative density of the in-situ soil. Infiltration rates can vary across the site depending on conditions encountered.

Site Drainage

The site should be graded so that surface water is directed off the site. Water should not be allowed to stand in any area where buildings or slabs are to be constructed. Loose surfaces should be sealed at the end of each workday by compacting the surface to reduce the potential for moisture infiltration into the soils. Final site grades should allow for drainage away from the building foundation. The ground should be sloped at a gradient of three percent for a distance of at least ten feet away from the buildings.

We recommend that a footing drain be installed around the perimeter of the buildings just below the invert of the footing with a gradient sufficient to initiate flow. Under no circumstances should the roof down spouts be connected to the footing drain system. We suggest that clean outs be installed at several accessible locations to allow for the periodic maintenance of the footing drain system. Details for the footing drain have been included on *Figure 3, Typical Footing Drain Detail*.

Utility Support and Back Fill

Based on the conditions encountered, the soil to be exposed by utility trenches should provide adequate support for utilities. Utility trench backfill is a concern in reducing the potential for settlement along utility alignments, particularly in pavement areas. It is also important that each section of utility line be adequately supported in the bedding material. The back fill material should be hand tamped to ensure support is provided around the pipe haunches.

Fill should be carefully placed and hand tamped to about twelve inches above the crown of the pipe before any compaction equipment is used. The remainder of the trench back fill should be placed in lifts having a loose thickness of eight inches.

A typical trench backfill section and compaction requirements for load supporting and non-load supporting areas is presented on *Figure 4, Utility Trench Backfill Detail*. Trench back fill may consist of imported granular fill provided the material is approved, placed and compacted near the optimum moisture content.

Imported granular material or on-site soil to be used as backfill should be submitted to our laboratory at least one week prior to construction so that we can provide a laboratory proctor for field density testing. If native soil is planned for use as backfill, additional testing may be required to determine the suitability of the material.

Pavements

The durability of pavements is related in part to the condition of the underlying sub grade. To provide a properly prepared sub grade for pavements, we recommend the sub grade be treated and prepared as described in the *Site Preparation and Grading* section of this report.

It is possible that some localized areas of soft, wet or unstable sub grade may still exist after this process. Before placement of any base rock, the sub grade should be compacted with suitable compaction equipment. Yielding areas that are identified should be excavated to firm material and replaced with compacted one and one quarter inch-minus clean-crushed rock. The following pavement sections are recommended for the proposed pavement areas:

- Entrance Driveway & Truck Turnaround - Four inches of Asphalt Concrete (AC) over ten inches of compacted Crushed Rock Base (CRB), over a geo-grid consisting of Tensar Triax or equivalent.
- Parking Stalls for Automobiles - Three inches of Asphalt Concrete (AC) over eight inches of compacted Crushed Rock Base (CRB) material.

The geo-grid should be placed directly on the sub grade surface of the driveway prior to placement of base rock. Appropriate geo-textiles have been designed to increase the strength of the sub grade and extend pavement life.

Asphaltic Cement (AC) and Crushed Rock Base (CRB) materials should conform to ODOT specifications. All base rock should be compacted to at least ninety-five percent (95 %) of the ASTM D1557-91 laboratory test standard.

We recommend that a minimum of eight inches of compacted CRB be placed below all exterior slabs. Exterior concrete slabs that are subject to vehicle traffic loads should be at five inches in thickness. It is also suggested that nominal reinforcement such as "6x6-10/10" welded wire mesh be installed, near midpoint, in new exterior concrete slabs and paving. Fiber mesh concrete may be used in lieu of welded wire mesh.

Additional Services & Earthwork Monitoring

Earth Engineering, Inc. will be available to provide consultation services related to review of the final design to verify that the recommendations within our purview have been properly interpreted and implemented in the approved construction plans and specifications. A representative from our office will be available to attend a pre-construction meeting to discuss and/or clarify all geotechnical issues related to the proposed project.

In addition, it is suggested that our office be retained to provide geotechnical services during construction to observe compliance with the design concepts and project specifications and to allow design changes in the event subsurface conditions differ from those anticipated. Our construction services would include monitoring and documenting the following:

- Verify that site has been adequately stripped of organic materials.
- Observe the condition of exposed bearing soils at the building area.
- Laboratory proctor tests for structural fill materials.
- Observe compaction and provide density testing of structural fill.
- Observe compaction and provide density testing of utility trench backfill.
- Provide footing inspection at building to verify soil bearing capacity.
- Verify the installation of all building and site drainage elements.

LIMITATIONS

Our recommendations and conclusions are based on the site materials observed, selective laboratory testing, engineering analyses, the design information provided to Earth Engineering, Inc. and our experience as well as engineering judgment. The conclusions and recommendations are professional opinions derived in a manner consistent with that level of care and skill ordinarily exercised by other members of the profession currently practicing under similar conditions in this area. No warranty is expressed or implied.

The recommendations submitted in this report are based upon the data obtained from the test pits. Soil and groundwater conditions may vary from those encountered. The nature and extent of variations may not become evident until construction. If variations do appear, Earth Engineering, Inc. should be requested to reevaluate the recommendations contained in this report and to modify or verify them in writing prior to proceeding with the proposed construction.

VICINITY MAP



Earth Engineering
GEOTECHNICAL & ENVIRONMENTAL SERVICES

CLIENT: LAZ AYALA

DRAWN: CCK

PROJECT:
WILSONVILLE CONVENIENCE STORE
29760 BOONES FERRY ROAD
WILSONVILLE, OR

DATE: 4/2022

FIGURE: 2

PRO. #: G14-0322

SITE PLAN

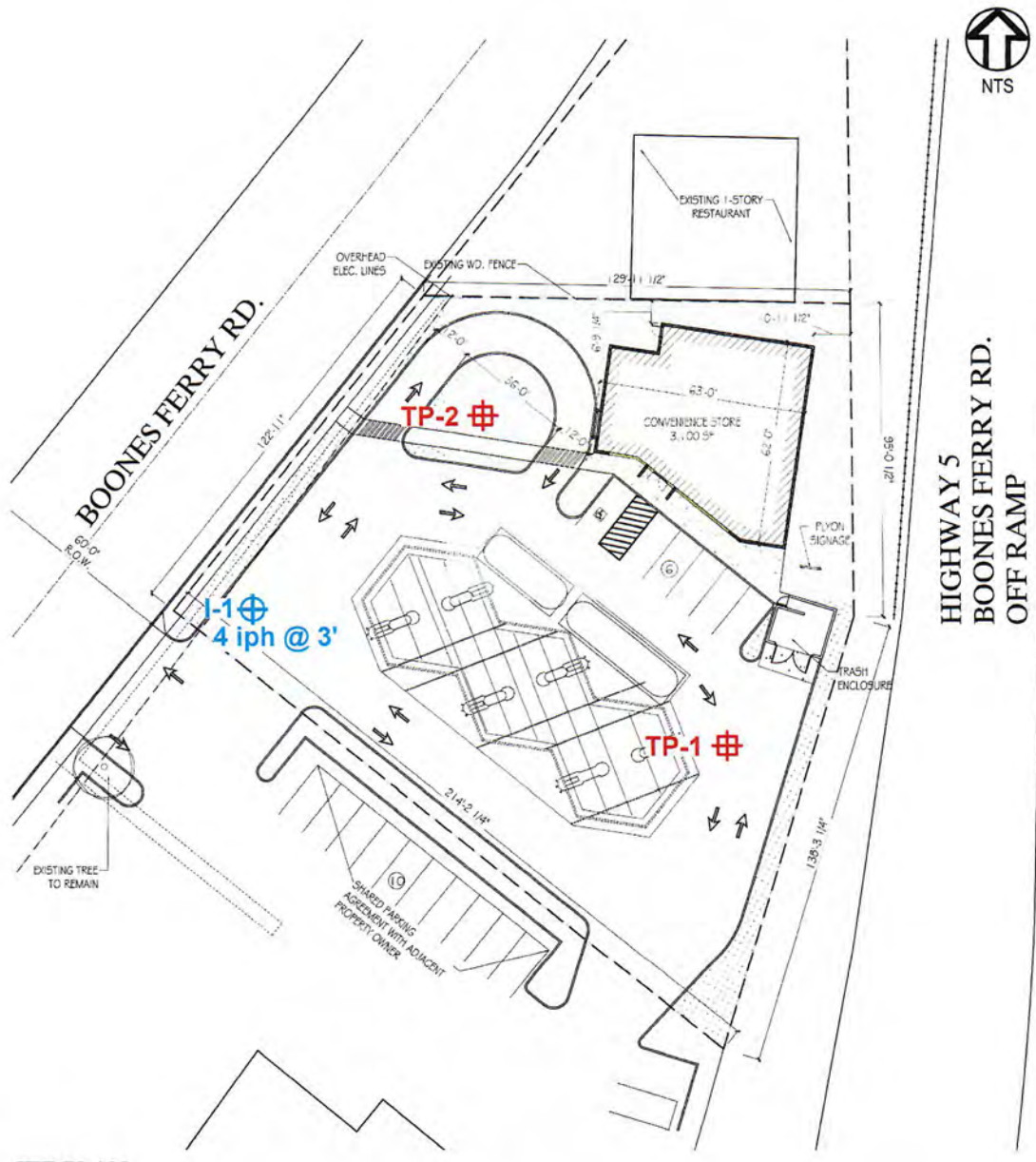

LEGEND

- TP-1 Approximate Location of Test Pits
- I-1 Approximate Location of Infiltration Test Pit



Earth Engineering

GEOTECHNICAL & ENVIRONMENTAL SERVICES

CLIENT: LAZ AYALA
 PROJECT: WILSONVILLE CONVENIENCE STORE
 29760 BOONES FERRY ROAD
 WILSONVILLE, OR

DRAWN: CCK
 DATE: 4/2022
 FIGURE: 2
 PRO. #: G14-0322

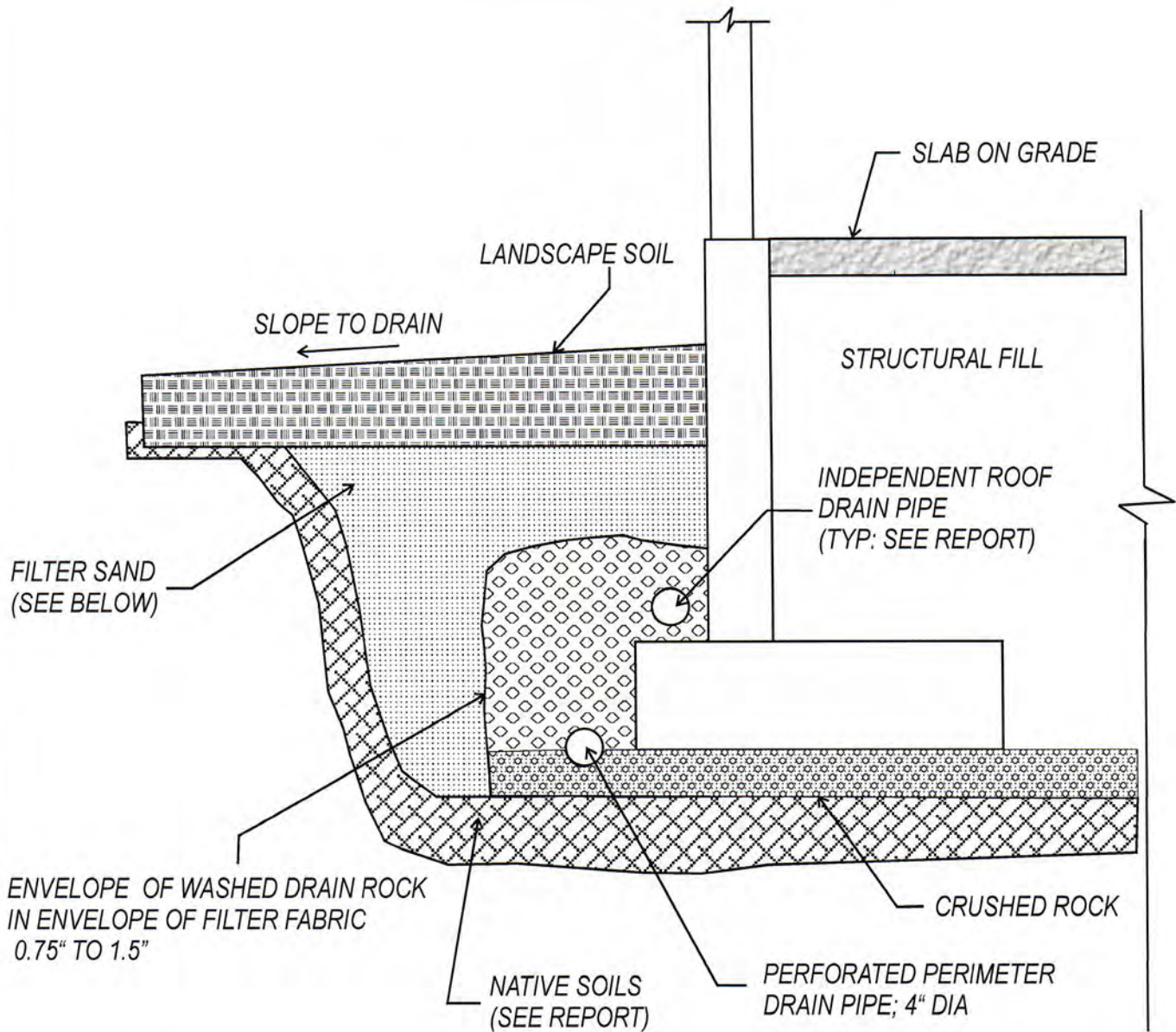

NOTES:

1. FILTER SAND - FINE AGGREGATE FOR PORTLAND CEMENT; SECTION 9-03.1(2)
2. PERFORATED OR SLOTTED RIGID PVC PIPE WITH A POSITIVE DRAINAGE GRADIENT
3. FILTER FABRIC OPTIONAL IF FILTER SAND USED

TYPICAL FOOTING DRAIN DETAIL

Not to Scale

 <p>Earth Engineering, Inc. GEOTECHNICAL & ENVIRONMENTAL SERVICES</p>	CLIENT:	AYALA	DRAWN:	EG
	PROJECT:	WILSONVILLE CONVENIENCE STORE 29760 BOONES FERRY ROAD WILSONVILLE, OR	DATE:	04/2022
			FIGURE:	3
			PRO. #:	G14-0322

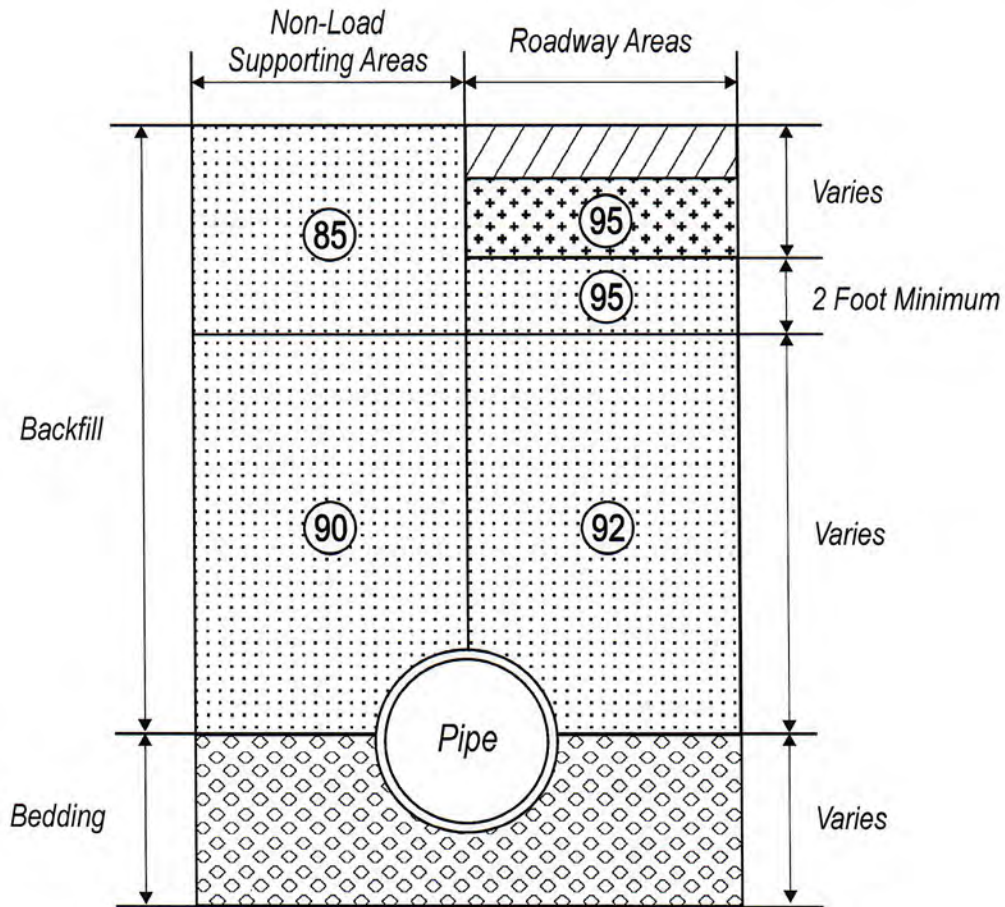

LEGEND



Asphalt or Concrete Pavement



Roadway Base Material or Base Rock



Backfill: Compacted on-site soil or imported select fill material as described in the site preparation of the general Earthwork Section of the attached report text.



Minimum percentage of maximum Laboratory Dry Density as determined by ASTM Test method D1557 (Modified Proctor), unless otherwise specified in the attached report text.



Bedding Material: Material type depends on type of pipe and laying conditions. Bedding should conform to the manufacturer's recommendations for the type of pipe selected.

UTILITY TRENCH BACKFILL DETAIL

Not to Scale



Earth Engineering, Inc.

GEOTECHNICAL & ENVIRONMENTAL CONSULTANTS

CLIENT:	AYALA	DRAWN:	EG
PROJECT:	WILSONVILLE CONVENIENCE STORE 29760 BOONES FERRY ROAD WILSONVILLE, OR	DATE:	04/2022
		FIGURE:	4
		PRO. #:	G14-0322

APPENDIX A

(FIELD EXPLORATION)

FIELD EXPLORATION

Our field exploration was performed on March 11th 2022. Subsurface conditions at the site were explored by excavating three test pits. The test pits were excavated to a maximum depth of eleven (11) feet below the existing ground surface. The test pits were excavated using a track-hoe.

The test pits were located by pacing from property features. The locations are shown on the Site Plan, Figure 2. Field exploration was monitored by an Earth Engineering, Inc. representative, who classified the soils that we encountered and maintained a log of each test pit, obtained representative samples, and observed pertinent site features. Representative soil samples were placed in closed containers and returned to the laboratory for further examination and testing.

All samples were identified using the Standard Classification of Soils for Engineering Purposes (ASTM D2487-93) in accordance with the Unified Soil Classification System (USCS), which is presented on Plate A-1. The test pit log and boring logs are presented in Appendix A. The final log represents our interpretations of the field logs and the results of the laboratory tests on field samples.

UNIFIED SOIL CLASSIFICATION SYSTEM

LEGEND

MAJOR DIVISIONS			GRAPH SYMBOL	LETTER SYMBOL	TYPICAL DESCRIPTION
Coarse Grained Soils	Gravel and Gravelly Soils More Than 50% Coarse Fraction Retained on No 4 Sieve	Clean Gravels (little or no fines)		GW gw	Well-Graded Gravels, Gravel-Sand Mixtures Little or no Fines
		Gravels with Fines (appreciable amount of fines)		GP gp	Poorly-Graded Gravels, Gravel-Sand Mixtures, Little or no Fines
	Sand and Sandy Soils More Than 50% Coarse Fraction Passing No 4 Sieve	Clean Sand (little or no fines)		SW sw	Well-graded Sands, Gravelly Sands Little or no Fines
		Sands with Fines (appreciable amount of fines)		SP sp	Poorly-Graded Sands, Gravelly Sands Little or no Fines
Fine Grained Soils	Silts and Clays	Liquid Limit Less than 50		SM sm	Silty Sands, Sand-Silt Mixtures
				SC sc	Clayey Sands, Sand-Clay Mixtures
				ML ml	Inorganic Silts and Very Fine Sands, Rock Flour, Silty-Clayey Fine Sands; Clayey Silts w/ slight Plasticity
	Silts and Clays	Liquid Limit Greater than 50		CL cl	Inorganic Clays of Low to Medium Plasticity, Gravelly Clays, Sandy Clays, Silty Clays, Lean
				OL ol	Organic Silts and Organic Silty Clays of Low Plasticity
				MH mh	Inorganic Silts, Micaceous or Diatomaceous Fine Sand or Silty Soils
				CH ch	Inorganic Clays of High Plasticity, Fat Clays
				OH oh	Organic Clays of Medium to High Plasticity, Organic Silts
Highly Organic Soils				PT pt	Peat, Humus, Swamp Soils with High Organic Contents

Topsoil		Humus and Duff Layer
Fill		Highly Variable Constituents



Earth Engineering Inc.

GEOTECHNICAL & ENVIRONMENTAL SERVICES

CLIENT:	AYALA	DRAWN:	EG
PROJECT:	WILSONVILLE CONVENIENCE STORE 29760 BOONES FERRY ROAD WILSONVILLE, OR	DATE:	04/2022
		PLATE:	A1
		PRO. #:	G14-0322

LOG OF TEST PIT

(West)

I-1

ELEVATION: +/- 160.5 feet
 EXPLORATORY EQUIPMENT: TRACK HOE
 DATE: 03/11/2022

DEPTH IN FEET	SAMPLES	SOILS CLASSIFICATION	LITHOLOGY (USGS)	COLOR	MOISTURE	CONSISTENCY	MOISTURE CONTENT % OF DRY WEIGHT	PERCENT PASS NUMBER 200
1	•	6" Topsoil						
2								
3		Field infiltration rate - 4 inches per hour						
4	•	lean Clay (CL)		Dark Brown	Moist	Firm to Stiff	26	-
5								
6								
7	•	(Native)					23	-
8								

Bottom of test pit at 8.0 feet below existing ground surface.
 No groundwater was encountered.



Earth Engineering, Inc.
 GEOTECHNICAL & ENVIRONMENTAL SERVICES

CLIENT:	AYALA	DRAWN:	EG
PROJECT:	WILSONVILLE CONVENIENCE STORE 29760 BOONES FERRY ROAD WILSONVILLE, OR	DATE:	04/2022
		PLATE:	A2
		PRO. #:	CM14-0322

LOG OF TEST PIT
(Northwest)

TP-1

ELEVATION: +/- 164 feet

EXPLORATORY EQUIPMENT: TRACK HOE

DATE: 03/11/2022

DEPTH IN FEET	SAMPLES	SOILS CLASSIFICATION	LITHOLOGY (USGS)	COLOR	MOISTURE	CONSISTENCY	MOISTURE CONTENT % OF DRY WEIGHT	PERCENT PASS NUMBER 200
1		4" Topsoil						
2		Wet γ ~113 pcf Dry γ ~93 pcf Liquid Limit - 38 Plastic Index -19 lean Clay (CL)		Dark Brown	Moist	Firm to Stiff	22	-
3		{gravel & cobbles}						
4		(Native)						
5								

Bottom of test pit at 5.0 feet below existing ground surface.
No groundwater was encountered.



Earth Engineering, Inc.

GEOTECHNICAL & ENVIRONMENTAL SERVICES

CLIENT:	AYALA	DRAWN:	EG
PROJECT:	WILSONVILLE CONVENIENCE STORE 29760 BOONES FERRY ROAD WILSONVILLE, OR	DATE:	04/2022
		PLATE:	A3
		PRO. #:	CM14-0322

LOG OF TEST PIT
(Northwest)

TP-2

ELEVATION: +/- 163 feet

EXPLORATORY EQUIPMENT: TRACK HOE

DATE: 03/11/2022

DEPTH IN FEET	SAMPLES	SOILS CLASSIFICATION	LITHOLOGY (USGS)	COLOR	MOISTURE	CONSISTENCY	MOISTURE CONTENT % OF DRY WEIGHT	PERCENT PASS NUMBER 200
1		6" Topsoil						
2	⊗	Wet γ ~114 pcf Dry γ ~94 pcf Liquid Limit - 32 Plastic Index - 15				Firm to Stiff	22	-
3								
4		{gravel & cobbles}						
5								
6	●	lean Clay (CL)		Dark Brown	Moist		29	-
7								
8								
9						Very Stiff to Hard		
10								
11		(Native)						

Bottom of test pit at 11.0 feet below existing ground surface.
No groundwater was encountered.



Earth Engineering, Inc.

GEOTECHNICAL & ENVIRONMENTAL SERVICES

CLIENT: AYALA

DRAWN: EG

PROJECT: WILSONVILLE
CONVENIENCE STORE
29760 BOONES FERRY ROAD
WILSONVILLE, OR

DATE: 04/2022

PLATE: A4

PRO. #: CM14-0322

APPENDIX B

(LABORATORY TESTING)

ATTERBERG LIMITS ASTM D4318-95

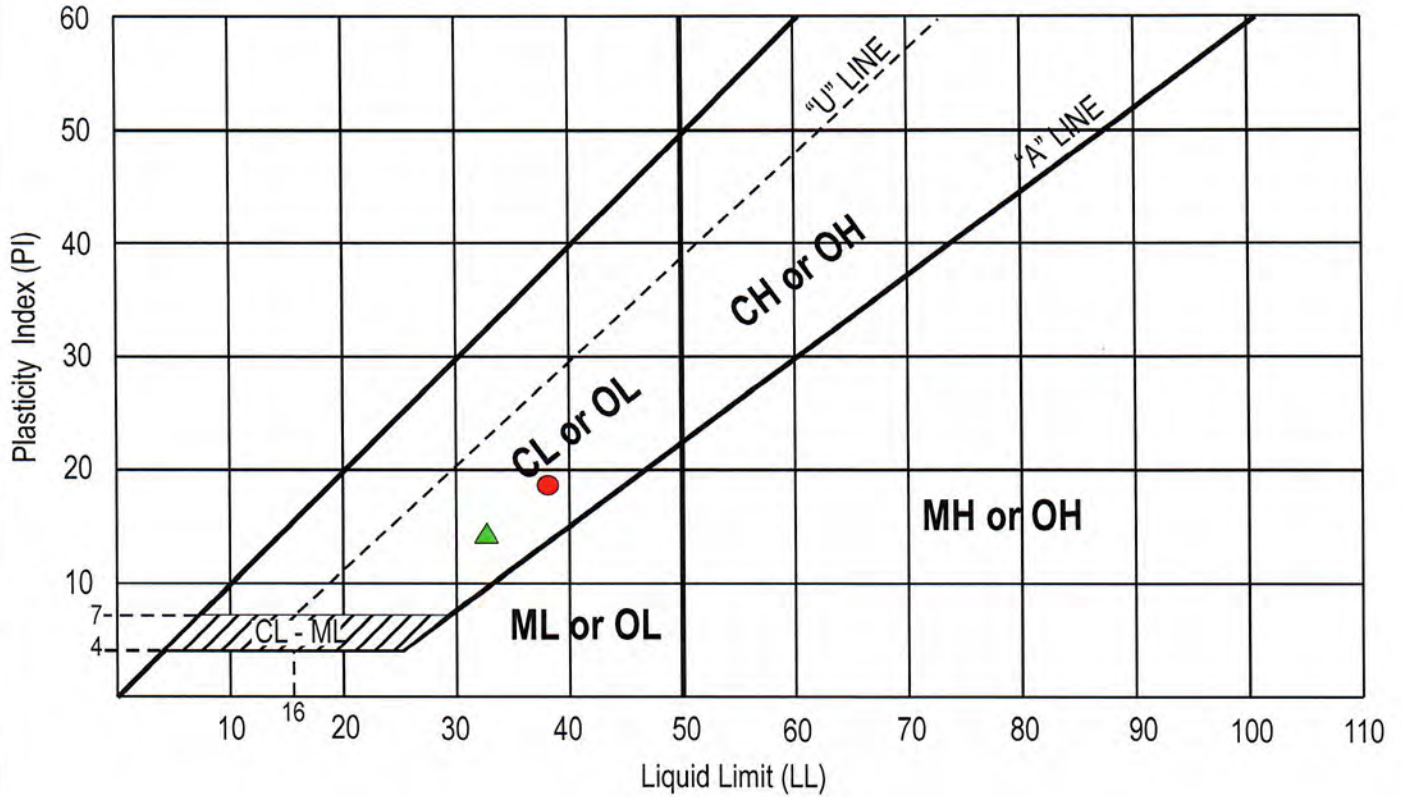

● TP-1 @ 2.0 feet bgs - lean Clay (CL)
Liquid Limit = 38 Plasticity Index = 19

▲ TP-2 @ 1.5 feet bgs - lean Clay (CL)
Liquid Limit = 32 Plasticity Index = 15



Earth Engineering, Inc.

GEOTECHNICAL & ENVIRONMENTAL SERVICES

CLIENT:	AYALA	DRAWN:	EG
PROJECT:	WILSONVILLE CONVENIENCE STORE 29760 BOONES FERRY ROAD WILSONVILLE, OR	DATE:	04/2022
		PLATE:	B1
		PRO. #:	G14-0322

DISTRIBUTION

{G14-0322}

1 Copy

PLS Engineering
604 W. Evergreen Blvd.
Vancouver, Washington 98660

Attention: Andrew Gunther

1 Copy

Laz Ayala
132 West Main Street
Medford, Oregon 97501

ADJUSTABLE BEAM WALL WASH 120V

5222

WAC

LANDSCAPE LIGHTING

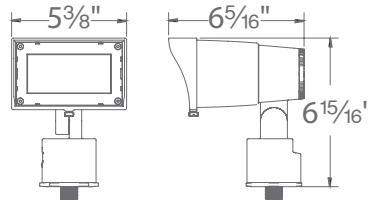

Fixture Type:

Catalog Number:

Project: _____

Location: _____

PRODUCT DESCRIPTION

With the ability to achieve beam distributions of 3x4 to 5x6 proportions and more, expect a uniform beam wash of light in a fixture that can adapt to changing needs. A powerhouse all-in-one unit in 120 VAC or 9-15VAC provides integral brightness control, and the ability to be dimmed, while being compatible with a range of accessories.

FEATURES

- Continuously adjustable NEMA beam distribution 3x4 (35" x 60"), 4x5 (60" x 90"), 5x6 (90" x 120")
- Integral brightness control
- Simple to retrofit existing line voltage systems or coordinate well with a new commercial landscape job
- IP65 Rated, protected against powerful water jets
- Solid die-cast brass or corrosion resistant aluminum alloy

SPECIFICATIONS

- Input:** 110V - 120VAC
- Power:** 3W to 25W
- Brightness:** 200 lm to 1550 lm
- Beam Angle:** Assorted NEMA distributions
- CRI:** 85
- Rated Life:** 45,000 hours

ORDERING NUMBER

	Color Temp	Finish
5222 Adjustable beam wall wash 120V	2700K 3000K	BK Black on Aluminum BZ Bronze on Aluminum BBR Bronze on Brass

5222-_____

Example: **5222-30BZ**

waclighting.com
Phone (800) 526.2588
Fax (800) 526.2585

Headquarters/Eastern Distribution Center
44 Harbor Park Drive
Port Washington, NY 11050

Central Distribution Center
1600 Distribution Ct
Lithia Springs, GA 30122

Western Distribution Center
1750 Archibald Avenue
Ontario, CA 91760

NEMA WALL WASH 5222
120V **3000K**

Product	Data	NEMA 6X5					NEMA 5X4					NEMA 4X3				
		CBCP	Lumen (LM)	VA(VA)	Efficacy (lm/w)	Beam Angle(°)	CBCP	Lumen (LM)	VA(VA)	Efficacy (lm/w)	Beam Angle(°)	CBCP	Lumen (LM)	VA(VA)	Efficacy (lm/w)	Beam Angle(°)
 5221	3w	27.91	65.3285	3.7	25.19	109.4x91.9	28.37	37.5558	3.7	14.39	92.8x52.2	27.72	20.8192	3.7	8	67.4x36.8
	7W	336.2	788.195	10.317	80.92	109.4x92.1	345.4	457.954	10.628	45.45	92.7x52.4	309.9	230.858	9.789	25.1	67.4x36.8
	15W	516.2	1210.71	15.884	78.13	109.4x92.1	554.5	735.277	17.419	43.09	92.7x52.5	546.2	406.751	17.4669	23.76	67.4x36.8
	23W	697.8	1636.5	22.756	72.86	109.4x92.2	707.4	938.414	23.39	40.62	92.7x52.4	686.5	511.514	22.768	22.77	67.4x36.9
	26W	723.8	1695.49	24.054	71.34	109.4x92.0	731.9	917.018	24.11	40.78	92.7x52.4	715.5	532.971	24.064	22.42	67.4x36.9

NEMA WALL WASH 5222
120V **2700K**

Product	Data	NEMA 6X5					NEMA 5X4					NEMA 4X3				
		CBCP	Lumen (LM)	VA(VA)	Efficacy (lm/w)	Beam Angle(°)	CBCP	Lumen (LM)	VA(VA)	Efficacy (lm/w)	Beam Angle(°)	CBCP	Lumen (LM)	VA(VA)	Efficacy (lm/w)	Beam Angle(°)
 5221	3w	26.91	62.9767	3.7	24.28	109.4x91.9	27.35	36.2038	3.7	13.88	92.8x52.2	26.72	20.0697	3.7	7.71	67.4x36.8
	7W	324.1	759.82	10.317	78.01	109.4x92.1	333	441.467	10.628	43.82	92.7x52.4	298.8	222.547	9.789	24.2	67.4x36.8
	15W	497.6	1167.13	15.884	75.31	109.4x92.1	534.6	708.809	17.419	41.54	92.7x52.5	526.5	392.108	17.469	22.9	67.4x36.8
	23W	672.6	1577.58	22.756	70.24	109.4x92.2	681.9	904.631	23.39	39.16	92.7x52.4	661.8	493.099	22.768	21.95	67.4x36.9
	26W	697.7	1634.45	24.054	68.78	109.4x92.0	705.5	936.061	24.11	39.31	92.7x52.4	689.7	513.784	24.064	21.61	67.4x36.9

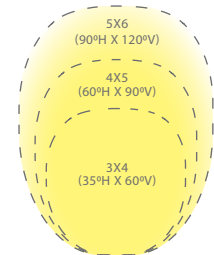
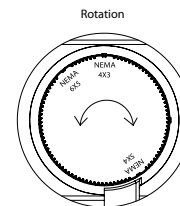
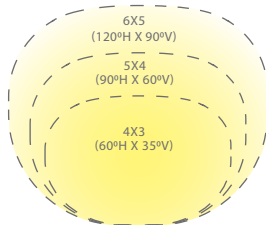
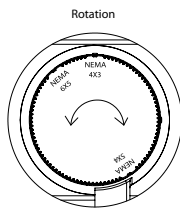

Architectural beam distributions from 3x4 to 4x5 to 5x6 proportions and everything in between. Always a uniform wide beam wash of light.



NEMA 5x4

→ NEMA 4x5

waclighting.com
Phone (800) 526.2588
Fax (800) 526.2585

Headquarters/Eastern Distribution Center
44 Harbor Park Drive
Port Washington, NY 11050

Central Distribution Center
1600 Distribution Ct
Lithia Springs, GA 30122

Western Distribution Center
1750 Archibald Avenue
Ontario, CA 91760

LANDSCAPE LED LANDSCAPE

ADJUSTABLE BEAM WALL WASH PHOTOMETRICS

FIXTURE	MOUNTING DISTANCE (d)	A	B	C	D	E	F
5221/5222 (4X3)	3ft	27.9fc	11.3fc	5.6fc	1.5fc	0.05fc	0.02fc
	4ft	15.7fc	6.3fc	3.2fc	0.85fc	0.03fc	0.01fc
	5ft	10.1fc	4.1fc	2fc	0.53fc	0.02fc	0.01fc
	6ft	7fc	2.8fc	1.4fc	0.37fc	0.01fc	-
	7ft	5.1fc	2.1fc	1fc	0.28fc	0.01fc	-
	8ft	4fc	1.6fc	0.79fc	0.21fc	0.01fc	-
	9ft	3.1fc	1.3fc	0.62fc	0.17fc	0.01fc	-
	10ft	2.5fc	1.0fc	0.51fc	0.14fc	-	-

In Multiples of Mounting Distance (Vertical)

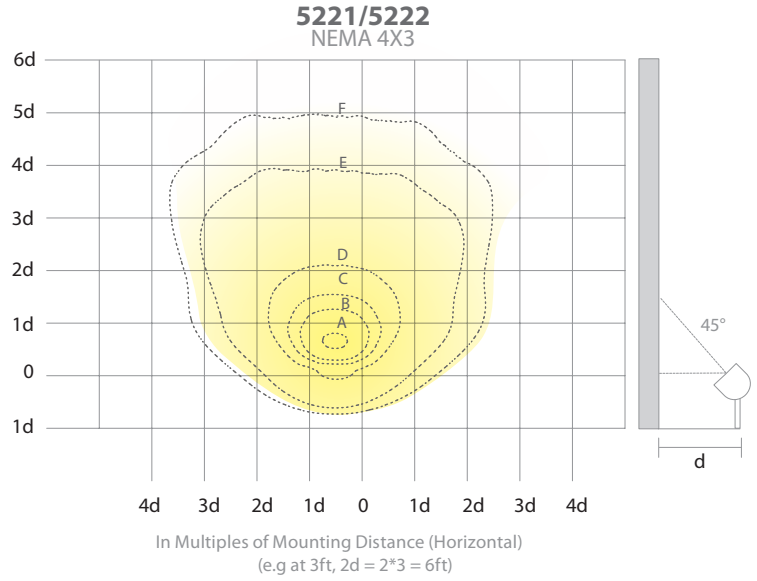

FIXTURE	MOUNTING DISTANCE (d)	A	B	C	D	E	F
5221/5222 (5X4)	3ft	28.9fc	13.4fc	7.9fc	3fc	0.36fc	0.14fc
	4ft	16.3fc	7.5fc	4.4fc	1.7fc	0.20fc	0.08fc
	5ft	10.4fc	4.8fc	2.8fc	1.1fc	0.13fc	0.05fc
	6ft	7.3fc	3.4fc	2.0fc	0.75fc	0.09fc	0.04fc
	7ft	5.3fc	2.5fc	1.5fc	0.55fc	0.07fc	0.03fc
	8ft	4.1fc	1.9fc	1.1fc	0.42fc	0.05fc	0.02fc
	9ft	3.2fc	1.5fc	0.87fc	0.33fc	0.04fc	0.02fc
	10ft	2.6fc	1.2fc	0.71fc	0.27fc	0.03fc	0.01fc

In Multiples of Mounting Distance (Vertical)

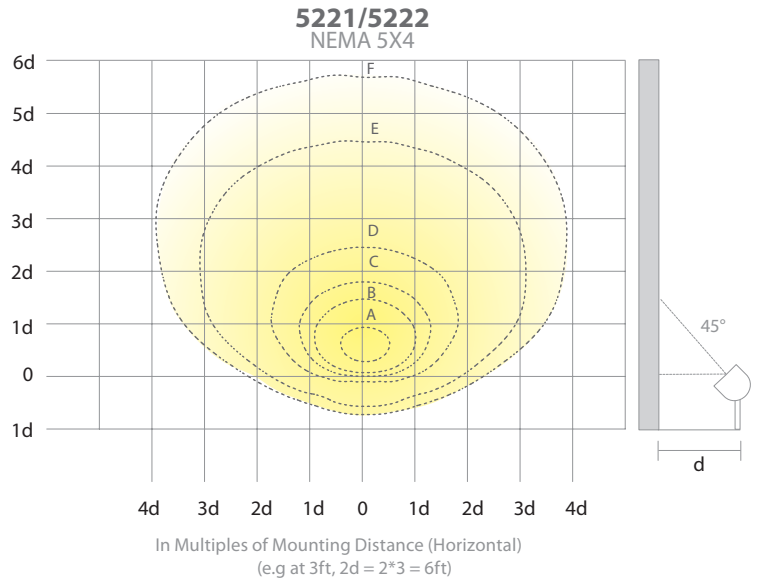





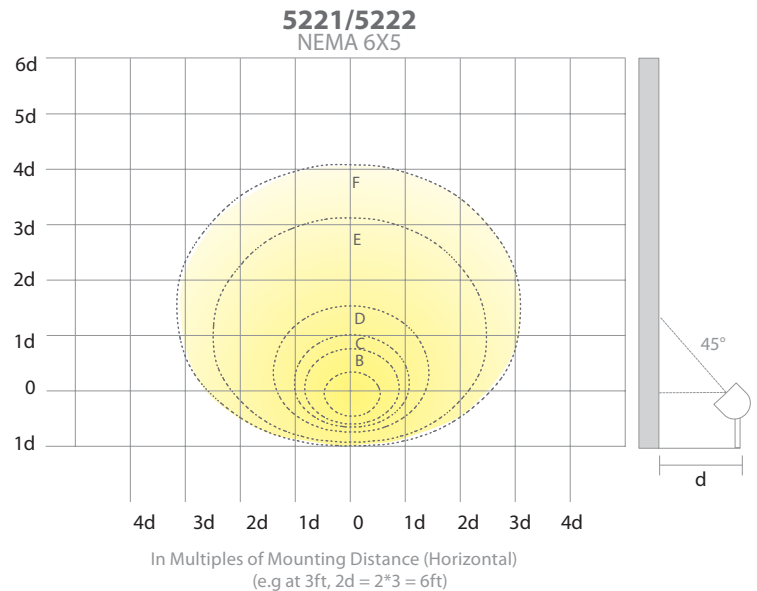

FIXTURE	MOUNTING DISTANCE (d)	A	B	C	D	E	F
5221/5222 (6X5)	3ft	28.9fc	13.6fc	8.8fc	4.1fc	0.70fc	0.32fc
	4ft	16.3fc	7.7fc	5.0fc	2.3fc	0.39fc	0.18fc
	5ft	10.4fc	4.9fc	3.2fc	1.5fc	0.25fc	0.12fc
	6ft	7.2fc	3.4fc	2.2fc	1.0fc	0.18fc	0.08fc
	7ft	5.3fc	2.5fc	1.6fc	0.75fc	0.13fc	0.06fc
	8ft	4.1fc	1.9fc	1.2fc	0.58fc	0.10fc	0.05fc
	9ft	3.2fc	1.5fc	0.98fc	0.45fc	0.08fc	0.04fc
	10ft	2.6fc	1.2fc	0.79fc	0.37fc	0.06fc	0.03fc

In Multiples of Mounting Distance (Vertical)



Accessories

14" Mounting Stake		9000-ST14-BZ	Bronze	Durable PC stake		
Surface Mount Flange/Stake		5000-SCP-BK 5000-SCP-BZ 5000-SCP-BBR	Black on Aluminum Bronze on Aluminum Bronze on Brass	Includes three 7 inch threaded stainless steel stabilizing pins for ground mounting or surface mounts with four screws or over a junction box		
Guardian Mount		9000-SP9-BZ	Stainless Steel	Heavy duty stainless steel spike to position fixture;		
Gutter Mount Bracket		5000-GM-BK 5000-GM-BZ	Black on Aluminum Bronze on Aluminum	Stainless steel universal mounting bracket for gutter mounting fixture		
Tree Mount Junction Box		5000-TCP-BK 5000-TCP-BZ	Black on Aluminum Bronze on Aluminum	Aluminum box with stainless steel mounting screws; two 1/2" NPT threaded holes, UL 120V Listed		
		5000-TCL-BK 5000-TCL-BZ	Black on Aluminum Bronze on Aluminum	Large Aluminum box with stainless steel mounting screws; two 1/2" NPT threaded holes, UL 120V Listed		
Large Tree Mount Canopy Strap		5000-TST-BK	Black on Steel and terylene	Ratcheting device with strap to be used with Large Tree Mount Junction Box (5000-TCL)		
Optics		LENS-3X5-AMB LENS-3X5-GRN LENS-3X5-RED	Amber Green Red	LENS-3X5-BLU Blue LENS-3X5-FR Frosted LENS-3X5-SPR Spread	LENS-3X5-BEL Beam Elongating	Enhances saturation of florals and foliage

14" Mounting stake (12V), detachable shroud, 6' lead wire and direct burial gel filled wire nuts (12V) or standard wire nuts (120V) included

waclighting.com
Phone (800) 526.2588
Fax (800) 526.2585

Headquarters/Eastern Distribution Center
44 Harbor Park Drive
Port Washington, NY 11050

Central Distribution Center
1600 Distribution Ct
Lithia Springs, GA 30122

Western Distribution Center
1750 Archibald Avenue
Ontario, CA 91760

WAC Lighting retains the right to modify the design of our products at any time as part of the company's continuous improvement program. 05/19/21



D-Series Size 1 LED Area Luminaire



Catalog Number
Notes
Type

Hit the Tab key or mouse over the page to see all interactive elements.

Specifications

EPA:	1.01 ft ² (0.09 m ²)
Length:	33" (83.8 cm)
Width:	13" (33.0 cm)
Height H1:	7-1/2" (19.0 cm)
Height H2:	3-1/2"
Weight (max):	27 lbs (12.2 kg)

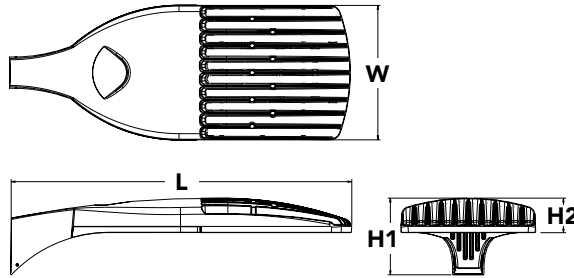

Introduction

The modern styling of the D-Series is striking yet unobtrusive - making a bold, progressive statement even as it blends seamlessly with its environment. The D-Series distills the benefits of the latest in LED technology into a high performance, high efficacy, long-life luminaire.

The outstanding photometric performance results in sites with excellent uniformity, greater pole spacing and lower power density. It is ideal for replacing up to 750W metal halide in pedestrian and area lighting applications with typical energy savings of 65% and expected service life of over 100,000 hours.

Ordering Information

EXAMPLE: DSX1 LED P7 40K T3M MVOLT SPA NLTAIR2 PIRHN DDBXD

Series	LEDs	Color temperature	Distribution	Voltage	Mounting
DSX1 LED	Forward optics P1 P4 ¹ P7 ¹ P2 P5 ¹ P8 P3 P6 ¹ P9 ¹ Rotated optics P10 ² P12 ² P11 ² P13 ^{1,2}	30K 3000 K 40K 4000 K 50K 5000 K	T1S Type I short (Automotive) T2S Type II short T2M Type II medium T3S Type III short T3M Type III medium T4M Type IV medium TFTM Forward throw medium T5VS Type V very short ³ T5S Type V short ³ T5M Type V medium ³ T5W Type V wide ³ BLC Backlight control ⁴ LCCO Left corner cutoff ⁴ RCCO Right corner cutoff ⁴	MVOLT ⁵ XVOLT (277V-480V) ^{6,7,8} 120 ⁹ 208 ⁹ 240 ⁹ 277 ⁹ 347 ⁹ 480 ⁹	Shipped included SPA Square pole mounting RPA Round pole mounting ¹⁰ WBA Wall bracket ³ SPUMBA Square pole universal mounting adaptor ¹¹ RPUMBA Round pole universal mounting adaptor ⁹ Shipped separately KMA8 DDBXD U Mast arm mounting bracket adaptor (specify finish) ¹²

Control options	Other options	Finish (required)
Shipped installed NLTAIR2 nLight AIR generation 2 enabled ¹³ PIRHN Network, high/low motion/ambient sensor ¹⁴ PER NEMA twist-lock receptacle only (controls ordered separate) ¹⁵ PER5 Five-pin receptacle only (controls ordered separate) ^{15,16} PER7 Seven-pin receptacle only (controls ordered separate) ^{15,16} DMG 0-10v dimming wires pulled outside fixture (for use with an external control, ordered separately) ¹⁷ DS Dual switching ^{18,19,20}	PIR High/low, motion/ambient sensor, 8-15' mounting height, ambient sensor enabled at 5fc ^{20,21} PIRH High/low, motion/ambient sensor, 15-30' mounting height, ambient sensor enabled at 5fc ^{20,21} PIR1FC3V High/low, motion/ambient sensor, 8-15' mounting height, ambient sensor enabled at 1fc ^{20,21} PIRH1FC3V Bi-level, motion/ambient sensor, 15-30' mounting height, ambient sensor enabled at 1fc ^{20,21} FAO Field adjustable output ^{20,21}	Shipped installed HS House-side shield ²³ SF Single fuse (120, 277, 347V) ⁹ DF Double fuse (208, 240, 480V) ⁹ L90 Left rotated optics ² R90 Right rotated optics ² HA 50°C ambient operations ¹ BAA Buy America(n) Act Compliant Shipped separately BS Bird spikes ²⁴ EGS External glare shield
		DDBXD Dark bronze DBLXD Black DNAXD Natural aluminum DWHXD White DDBTXD Textured dark bronze DBLBXD Textured black DNATXD Textured natural aluminum DWHGXD Textured white



Ordering Information

Accessories

Ordered and shipped separately.

DLL127F 1.5 JU	Photocell - SSL twist-lock (120-277V) ²⁵
DLL347F 1.5 CUL JU	Photocell - SSL twist-lock (347V) ²⁵
DLL480F 1.5 CUL JU	Photocell - SSL twist-lock (480V) ²⁵
DSHORT SBK U	Shorting cap ²⁵
DSX1HS 30C U	House-side shield for P1, P2, P3, P4 and P5 ²³
DSX1HS 40C U	House-side shield for P6 and P7 ²³
DSX1HS 60C U	House-side shield for P8, P9, P10, P11 and P12 ²³
PUMBA DDBXD U*	Square and round pole universal mounting bracket (specify finish) ²⁵
KMA8 DDBXD U	Mast arm mounting bracket adaptor (specify finish) ¹²
DSX1EGS (FINISH) U	External glare shield

For more control options, visit [DTL](#) and [ROAM](#) online.

NOTES

- 1 HA not available with P4, P5, P6, P7, P9 and P13.
- 2 P10, P11, P12 or P13 and rotated optics (L90, R90) only available together.
- 3 Any Type 5 distribution with photocell, is not available with WBA.
- 4 Not available with HS.
- 5 MVOLT driver operates on any line voltage from 120-277V (50/60 Hz).
- 6 XVOLT only suitable for use with P3, P5, P6, P7, P9 and P13.
- 7 XVOLT works with any voltage between 277V and 480V.
- 8 XVOLT not available with fusing (SF or DF) and not available with PIR, PIRH, PIR1FC3V, PIRH1FC3V.
- 9 Single fuse (SF) requires 120V, 277V or 347V. Double fuse (DF) requires 208V, 240V or 480V. XVOLT not available with fusing (SF or DF).
- 10 Suitable for mounting to round poles between 3.5" and 12" diameter.
- 11 Universal mounting brackets intended for retrofit on existing, pre-drilled poles only. 1.5 G vibration load rating per ANCI C136.31. Only usable when pole's drill pattern is NOT Lithonia template #8.
- 12 Must order fixture with SPA option. Must be ordered as a separate accessory; see Accessories information. For use with 2-3/8" diameter mast arm (not included).
- 13 Must be ordered with PIRHN. Sensor cover available only in dark bronze, black, white and natural aluminum colors.
- 14 Must be ordered with NLTAR2. For more information on nLight Air 2 visit [this link](#).
- 15 Photocell ordered and shipped as a separate line item from Acuity Brands Controls. See accessories. Shorting cap included.
- 16 If ROAM® node required, it must be ordered and shipped as a separate line item from Acuity Brands Controls. Node with integral dimming.
- 17 DMG not available with PIRHN, PER5, PER7, PIR, PIRH, PIR1FC3V or PIRH1FC3V, FAO.
- 18 Provides 50/50 fixture operation via (2) independent drivers. Not available with PER, PER5, PER7, PIR or PIRH. Not available P1, P2, P3, P4 or P5.
- 19 Requires (2) separately switched circuits with isolated neutral.
- 20 Reference Controls Option Default settings table on page 4.
- 21 Reference Motion Sensor table on page 4 to see functionality.
- 22 Not available with other dimming controls options.
- 23 Not available with BLC, LCCO and RCCO distribution. Also available as a separate accessory; see Accessories information.
- 24 Must be ordered with fixture for factory pre-drilling.
- 25 Requires luminaire to be specified with PER, PER5 or PER7 option. See Control Option Table on page 4.
- 26 For retrofit use only. Only usable when pole's drill pattern is NOT Lithonia template #8.

Options

EGS - External Glare Shield

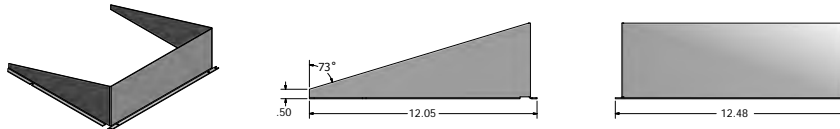

Drilling

HANDHOLE ORIENTATION

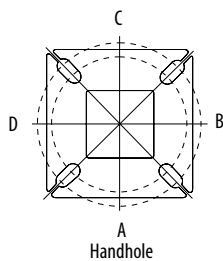

Tenon Mounting Slipfitter

Tenon O.D.	Mounting	Single Unit	2 @ 180	2 @ 90	3 @ 90	3 @ 120	4 @ 90
2-3/8"	RPA	AS3-5 190	AS3-5 280	AS3-5 290	AS3-5 390	AS3-5 320	AS3-5 490
2-7/8"	RPA	AST25-190	AST25-280	AST25-290	AST25-390	AST25-320	AST25-490
4"	RPA	AST35-190	AST35-280	AST35-290	AST35-390	AST35-320	AST35-490

Mounting Option	Drilling Template	Single	2 @ 180	2 @ 90	3 @ 90	3 @ 120	4 @ 90
Head Location		Side B	Side B & D	Side B & C	Side B, C & D	Round Pole Only	Side A, B, C & D
Drill Nomenclature	#8	DM19AS	DM28AS	DM29AS	DM39AS	DM32AS	DM49AS

DSX1 Area Luminaire - EPA

*Includes luminaire and integral mounting arm. Other tenons, arms, brackets or other accessories are not included in this EPA data.

Fixture Quantity & Mounting Configuration	Single DM19	2 @ 180 DM28	2 @ 90 DM29	3 @ 90 DM39	3 @ 120 DM32	4 @ 90 DM49
Mounting Type						
DSX1 LED	1.013	2.025	1.945	3.038	2.850	3.749

	Drilling Template	Minimum Acceptable Outside Pole Dimension					
SPA	#8	2-7/8"	2-7/8"	3.5"	3.5"	3"	3.5"
RPA	#8	2-7/8"	2-7/8"	3.5"	3.5"	3"	3.5"
SPUMBA	#5	2-7/8"	3"	4"	4"	3.5"	4"
RPUMBA	#5	2-7/8"	3.5"	5"	5"	3.5"	5"

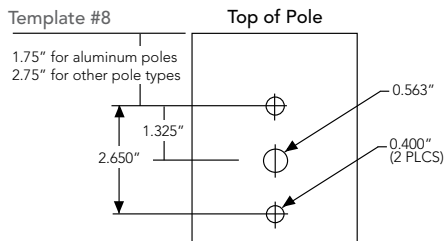

Photometric Diagrams

To see complete photometric reports or download .ies files for this product, visit Lithonia Lighting's [D-Series Area Size 1 homepage](#).

Isofootcandle plots for the DSX1 LED 60C 1000 40K. Distances are in units of mounting height (25').

LEGEND

- 0.1 fc
- 0.5 fc
- 1.0 fc

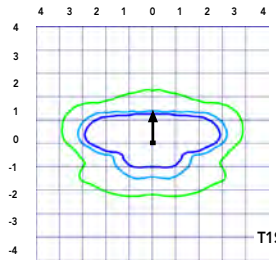

Test No. LTL23211 tested in accordance with IESNA LM-79-08.

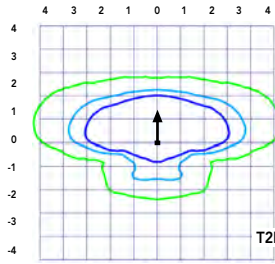

Test No. LTL23164B tested in accordance with IESNA LM-79-08.

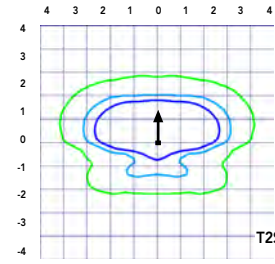

Test No. LTL23222 tested in accordance with IESNA LM-79-08.

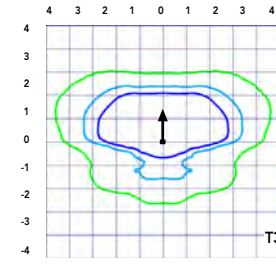

Test No. LTL23271 tested in accordance with IESNA LM-79-08.

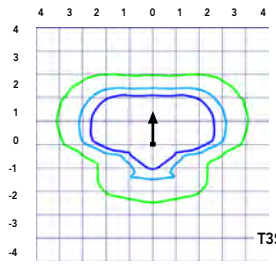

Test No. LTL23211 tested in accordance with IESNA LM-79-08.

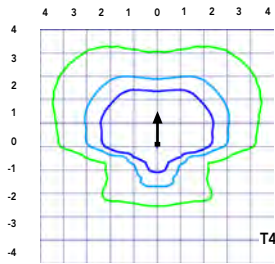

Test No. LTL23164B tested in accordance with IESNA LM-79-08.

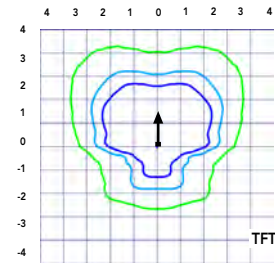

Test No. LTL23222 tested in accordance with IESNA LM-79-08.

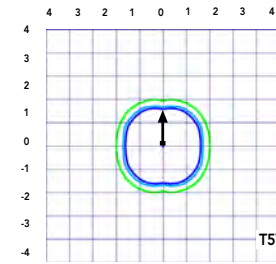

Test No. LTL23271 tested in accordance with IESNA LM-79-08.

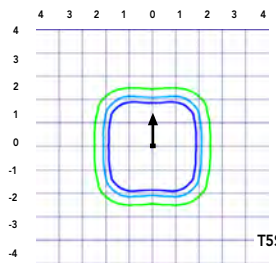

Test No. LTL23211 tested in accordance with IESNA LM-79-08.

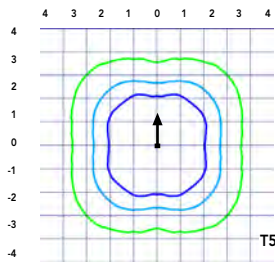

Test No. LTL23164B tested in accordance with IESNA LM-79-08.

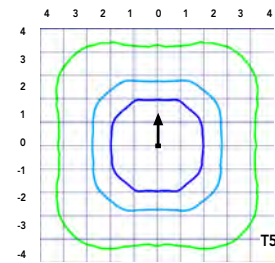

Test No. LTL23222 tested in accordance with IESNA LM-79-08.

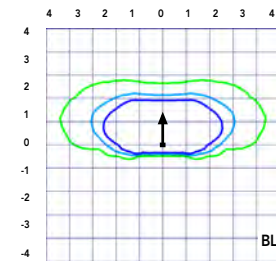

Test No. LTL23271 tested in accordance with IESNA LM-79-08.

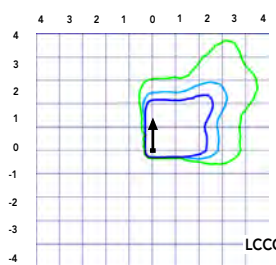

Test No. LTL23211 tested in accordance with IESNA LM-79-08.

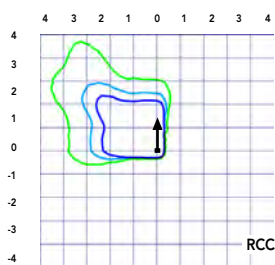

Test No. LTL23164B tested in accordance with IESNA LM-79-08.

Performance Data

Lumen Ambient Temperature (LAT) Multipliers

Use these factors to determine relative lumen output for average ambient temperatures from 0-40°C (32-104°F).

Ambient		Lumen Multiplier
0°C	32°F	1.04
5°C	41°F	1.04
10°C	50°F	1.03
15°C	59°F	1.02
20°C	68°F	1.01
25°C	77°F	1.00
30°C	86°F	0.99
35°C	95°F	0.98
40°C	104°F	0.97

Projected LED Lumen Maintenance

Data references the extrapolated performance projections for the platforms noted in a **25°C ambient**, based on 10,000 hours of LED testing (tested per IESNA LM-80-08 and projected per IESNA TM-21-11).

To calculate LLF, use the lumen maintenance factor that corresponds to the desired number of operating hours below. For other lumen maintenance values, contact factory.

Operating Hours	Lumen Maintenance Factor
0	1.00
25,000	0.96
50,000	0.92
100,000	0.85

Motion Sensor Default Settings

Option	Dimmed State	High Level (when triggered)	Photocell Operation	Dwell Time	Ramp-up Time	Ramp-down Time
PIR or PIRH	3V (37%) Output	10V (100%) Output	Enabled @ 5FC	5 min	3 sec	5 min
*PIR1FC3V or PIRH1FC3V	3V (37%) Output	10V (100%) Output	Enabled @ 1FC	5 min	3 sec	5 min

*for use when motion sensor is used as dusk to dawn control.

Electrical Load

	Performance Package	LED Count	Drive Current	Wattage	Current (A)					
					120	208	240	277	347	480
Forward Optics (Non-Rotated)	P1	30	530	54	0.45	0.26	0.23	0.19	0.10	0.12
	P2	30	700	70	0.59	0.34	0.30	0.25	0.20	0.16
	P3	30	1050	102	0.86	0.50	0.44	0.38	0.30	0.22
	P4	30	1250	125	1.06	0.60	0.52	0.46	0.37	0.27
	P5	30	1400	138	1.16	0.67	0.58	0.51	0.40	0.29
	P6	40	1250	163	1.36	0.78	0.68	0.59	0.47	0.34
	P7	40	1400	183	1.53	0.88	0.76	0.66	0.53	0.38
	P8	60	1050	207	1.74	0.98	0.87	0.76	0.64	0.49
	P9	60	1250	241	2.01	1.16	1.01	0.89	0.70	0.51
Rotated Optics (Requires L90 or R90)	P10	60	530	106	0.90	0.52	0.47	0.43	0.33	0.27
	P11	60	700	137	1.15	0.67	0.60	0.53	0.42	0.32
	P12	60	1050	207	1.74	0.99	0.87	0.76	0.60	0.46
	P13	60	1250	231	1.93	1.12	0.97	0.86	0.67	0.49

Controls Options

Nomenclature	Description	Functionality	Primary control device	Notes
FA0	Field adjustable output device installed inside the luminaire; wired to the driver dimming leads.	Allows the luminaire to be manually dimmed, effectively trimming the light output.	FA0 device	Cannot be used with other controls options that need the 0-10V leads
DS	Drivers wired independently for 50/50 luminaire operation	The luminaire is wired to two separate circuits, allowing for 50/50 operation.	Independently wired drivers	Requires two separately switched circuits. Consider nLight AIR as a more cost effective alternative.
PERS or PER7	Twist-lock photocell receptacle	Compatible with standard twist-lock photocells for dusk to dawn operation, or advanced control nodes that provide 0-10V dimming signals.	Twist-lock photocells such as DLL Elite or advanced control nodes such as ROAM.	Pins 4 & 5 to dimming leads on driver, Pins 6 & 7 are capped inside luminaire
PIR or PIRH	Motion sensors with integral photocell. PIR for 8-15' mounting; PIRH for 15-30' mounting	Luminaires dim when no occupancy is detected.	Acuity Controls SBGR	Also available with PIRH1FC3V when the sensor photocell is used for dusk-to-dawn operation.
NLTAIR2 PIRHN	nLight AIR enabled luminaire for motion sensing, photocell and wireless communication.	Motion and ambient light sensing with group response. Scheduled dimming with motion sensor over-ride when wirelessly connected to the nLight Eclipse.	nLight Air rSDGR	nLight AIR sensors can be programmed and commissioned from the ground using the CIAIRity Pro app.

Performance Data

Lumen Output

Lumen values are from photometric tests performed in accordance with IESNA LM-79-08. Data is considered to be representative of the configurations shown, within the tolerances allowed by Lighting Facts Contact factory for performance data on any configurations not shown here.

Forward Optics																			
LED Count	Drive Current	Power Package	System Watts	Dist. Type	30K (3000 K, 70 CRI)					40K (4000 K, 70 CRI)					50K (5000 K, 70 CRI)				
					Lumens	B	U	G	LPW	Lumens	B	U	G	LPW	Lumens	B	U	G	LPW
30	530	P1	54W	T1S	6,457	2	0	2	120	6,956	2	0	2	129	7,044	2	0	2	130
				T2S	6,450	2	0	2	119	6,949	2	0	2	129	7,037	2	0	2	130
				T2M	6,483	1	0	1	120	6,984	2	0	2	129	7,073	2	0	2	131
				T3S	6,279	2	0	2	116	6,764	2	0	2	125	6,850	2	0	2	127
				T3M	6,468	1	0	2	120	6,967	1	0	2	129	7,056	1	0	2	131
				T4M	6,327	1	0	2	117	6,816	1	0	2	126	6,902	1	0	2	128
				TFTM	6,464	1	0	2	120	6,963	1	0	2	129	7,051	1	0	2	131
				TSVS	6,722	2	0	0	124	7,242	3	0	0	134	7,334	3	0	0	136
				T5S	6,728	2	0	1	125	7,248	2	0	1	134	7,340	2	0	1	136
				T5M	6,711	3	0	1	124	7,229	3	0	1	134	7,321	3	0	2	136
				TSW	6,667	3	0	2	123	7,182	3	0	2	133	7,273	3	0	2	135
				BLC	5,299	1	0	1	98	5,709	1	0	2	106	5,781	1	0	2	107
				LCCO	3,943	1	0	2	73	4,248	1	0	2	79	4,302	1	0	2	80
				RCCO	3,943	1	0	2	73	4,248	1	0	2	79	4,302	1	0	2	80
30	700	P2	70W	T1S	8,249	2	0	2	118	8,886	2	0	2	127	8,999	2	0	2	129
				T2S	8,240	2	0	2	118	8,877	2	0	2	127	8,989	2	0	2	128
				T2M	8,283	2	0	2	118	8,923	2	0	2	127	9,036	2	0	2	129
				T3S	8,021	2	0	2	115	8,641	2	0	2	123	8,751	2	0	2	125
				T3M	8,263	2	0	2	118	8,901	2	0	2	127	9,014	2	0	2	129
				T4M	8,083	2	0	2	115	8,708	2	0	2	124	8,818	2	0	2	126
				TFTM	8,257	2	0	2	118	8,896	2	0	2	127	9,008	2	0	2	129
				TSVS	8,588	3	0	0	123	9,252	3	0	0	132	9,369	3	0	0	134
				T5S	8,595	3	0	1	123	9,259	3	0	1	132	9,376	3	0	1	134
				T5M	8,573	3	0	2	122	9,236	3	0	2	132	9,353	3	0	2	134
				TSW	8,517	3	0	2	122	9,175	4	0	2	131	9,291	4	0	2	133
				BLC	6,770	1	0	2	97	7,293	1	0	2	104	7,386	1	0	2	106
				LCCO	5,038	1	0	2	72	5,427	1	0	2	78	5,496	1	0	2	79
				RCCO	5,038	1	0	2	72	5,427	1	0	2	78	5,496	1	0	2	79
30	1050	P3	102W	T1S	11,661	2	0	2	114	12,562	3	0	3	123	12,721	3	0	3	125
				T2S	11,648	2	0	2	114	12,548	3	0	3	123	12,707	3	0	3	125
				T2M	11,708	2	0	2	115	12,613	2	0	2	124	12,773	2	0	2	125
				T3S	11,339	2	0	2	111	12,215	3	0	3	120	12,370	3	0	3	121
				T3M	11,680	2	0	2	115	12,582	2	0	2	123	12,742	2	0	2	125
				T4M	11,426	2	0	3	112	12,309	2	0	3	121	12,465	2	0	3	122
				TFTM	11,673	2	0	2	114	12,575	2	0	3	123	12,734	2	0	3	125
				TSVS	12,140	3	0	1	119	13,078	3	0	1	128	13,244	3	0	1	130
				T5S	12,150	3	0	1	119	13,089	3	0	1	128	13,254	3	0	1	130
				T5M	12,119	4	0	2	119	13,056	4	0	2	128	13,221	4	0	2	130
				TSW	12,040	4	0	3	118	12,970	4	0	3	127	13,134	4	0	3	129
				BLC	9,570	1	0	2	94	10,310	1	0	2	101	10,440	1	0	2	102
				LCCO	7,121	1	0	3	70	7,671	1	0	3	75	7,768	1	0	3	76
				RCCO	7,121	1	0	3	70	7,671	1	0	3	75	7,768	1	0	3	76
30	1250	P4	125W	T1S	13,435	3	0	3	107	14,473	3	0	3	116	14,657	3	0	3	117
				T2S	13,421	3	0	3	107	14,458	3	0	3	116	14,641	3	0	3	117
				T2M	13,490	2	0	2	108	14,532	3	0	3	116	14,716	3	0	3	118
				T3S	13,064	3	0	3	105	14,074	3	0	3	113	14,252	3	0	3	114
				T3M	13,457	2	0	2	108	14,497	2	0	2	116	14,681	2	0	2	117
				T4M	13,165	2	0	3	105	14,182	2	0	3	113	14,362	2	0	3	115
				TFTM	13,449	2	0	3	108	14,488	2	0	3	116	14,672	2	0	3	117
				TSVS	13,987	4	0	1	112	15,068	4	0	1	121	15,259	4	0	1	122
				T5S	13,999	3	0	1	112	15,080	3	0	1	121	15,271	3	0	1	122
				T5M	13,963	4	0	2	112	15,042	4	0	2	120	15,233	4	0	2	122
				TSW	13,872	4	0	3	111	14,944	4	0	3	120	15,133	4	0	3	121
				BLC	11,027	1	0	2	88	11,879	1	0	2	95	12,029	1	0	2	96
				LCCO	8,205	1	0	3	66	8,839	1	0	3	71	8,951	1	0	3	72
				RCCO	8,205	1	0	3	66	8,839	1	0	3	71	8,951	1	0	3	72
30	1400	P5	138W	T1S	14,679	3	0	3	106	15,814	3	0	3	115	16,014	3	0	3	116
				T2S	14,664	3	0	3	106	15,797	3	0	3	114	15,997	3	0	3	116
				T2M	14,739	3	0	3	107	15,878	3	0	3	115	16,079	3	0	3	117
				T3S	14,274	3	0	3	103	15,377	3	0	3	111	15,572	3	0	3	113
				T3M	14,704	2	0	3	107	15,840	3	0	3	115	16,040	3	0	3	116
				T4M	14,384	2	0	3	104	15,496	3	0	3	112	15,692	3	0	3	114
				TFTM	14,695	2	0	3	106	15,830	3	0	3	115	16,030	3	0	3	116
				TSVS	15,283	4	0	1	111	16,464	4	0	1	119	16,672	4	0	1	121
				T5S	15,295	3	0	1	111	16,477	4	0	1	119	16,686	4	0	1	121
				T5M	15,257	4	0	2	111	16,435	4	0	2	119	16,644	4	0	2	121
				TSW	15,157	4	0	3	110	16,328	4	0	3	118	16,534	4	0	3	120
				BLC	12,048	1	0	2	87	12,979	1	0	2	94	13,143	1	0	2	95
				LCCO	8,965	1	0	3	65	9,657	1	0	3	70	9,780	1	0	3	71
				RCCO	8,965	1	0	3	65	9,657	1	0	3	70	9,780	1	0	3	71



Performance Data

Lumen Output

Lumen values are from photometric tests performed in accordance with IESNA LM-79-08. Data is considered to be representative of the configurations shown, within the tolerances allowed by Lighting Facts. Contact factory for performance data on any configurations not shown here.

Forward Optics																			
LED Count	Drive Current	Power Package	System Watts	Dist. Type	30K (3000 K, 70 CRI)					40K (4000 K, 70 CRI)					50K (5000 K, 70 CRI)				
					Lumens	B	U	G	LPW	Lumens	B	U	G	LPW	Lumens	B	U	G	LPW
40	1250	P6	163W	T1S	17,654	3	0	3	108	19,018	3	0	3	117	19,259	3	0	3	118
				T2S	17,635	3	0	3	108	18,998	3	0	3	117	19,238	3	0	3	118
				T2M	17,726	3	0	3	109	19,096	3	0	3	117	19,337	3	0	3	119
				T3S	17,167	3	0	3	105	18,493	3	0	3	113	18,727	3	0	3	115
				T3M	17,683	3	0	3	108	19,049	3	0	3	117	19,290	3	0	3	118
				T4M	17,299	3	0	3	106	18,635	3	0	4	114	18,871	3	0	4	116
				TFTM	17,672	3	0	3	108	19,038	3	0	4	117	19,279	3	0	4	118
				TSVS	18,379	4	0	1	113	19,800	4	0	1	121	20,050	4	0	1	123
				T5S	18,394	4	0	2	113	19,816	4	0	2	122	20,066	4	0	2	123
				T5M	18,348	4	0	2	113	19,766	4	0	2	121	20,016	4	0	2	123
				TSW	18,228	5	0	3	112	19,636	5	0	3	120	19,885	5	0	3	122
				BLC	14,489	2	0	2	89	15,609	2	0	3	96	15,806	2	0	3	97
				LCCO	10,781	1	0	3	66	11,614	1	0	3	71	11,761	2	0	3	72
				RCCO	10,781	1	0	3	66	11,614	1	0	3	71	11,761	2	0	3	72
40	1400	P7	183W	T1S	19,227	3	0	3	105	20,712	3	0	3	113	20,975	3	0	3	115
				T2S	19,206	3	0	3	105	20,690	3	0	3	113	20,952	3	0	3	114
				T2M	19,305	3	0	3	105	20,797	3	0	3	114	21,060	3	0	3	115
				T3S	18,696	3	0	3	102	20,141	3	0	3	110	20,396	3	0	4	111
				T3M	19,258	3	0	3	105	20,746	3	0	3	113	21,009	3	0	3	115
				T4M	18,840	3	0	4	103	20,296	3	0	4	111	20,553	3	0	4	112
				TFTM	19,246	3	0	4	105	20,734	3	0	4	113	20,996	3	0	4	115
				TSVS	20,017	4	0	1	109	21,564	4	0	1	118	21,837	4	0	1	119
				T5S	20,033	4	0	2	109	21,581	4	0	2	118	21,854	4	0	2	119
				T5M	19,983	4	0	2	109	21,527	5	0	3	118	21,799	5	0	3	119
				TSW	19,852	5	0	3	108	21,386	5	0	3	117	21,656	5	0	3	118
				BLC	15,780	2	0	3	86	16,999	2	0	3	93	17,214	2	0	3	94
				LCCO	11,742	2	0	3	64	12,649	2	0	3	69	12,809	2	0	3	70
				RCCO	11,742	2	0	3	64	12,649	2	0	3	69	12,809	2	0	3	70
60	1050	P8	207W	T1S	22,490	3	0	3	109	24,228	3	0	3	117	24,535	3	0	3	119
				T2S	22,466	3	0	4	109	24,202	3	0	4	117	24,509	3	0	4	118
				T2M	22,582	3	0	3	109	24,327	3	0	3	118	24,635	3	0	3	119
				T3S	21,870	3	0	4	106	23,560	3	0	4	114	23,858	3	0	4	115
				T3M	22,527	3	0	4	109	24,268	3	0	4	117	24,575	3	0	4	119
				T4M	22,038	3	0	4	106	23,741	3	0	4	115	24,041	3	0	4	116
				TFTM	22,513	3	0	4	109	24,253	3	0	4	117	24,560	3	0	4	119
				TSVS	23,415	5	0	1	113	25,224	5	0	1	122	25,543	5	0	1	123
				T5S	23,434	4	0	2	113	25,244	4	0	2	122	25,564	4	0	2	123
				T5M	23,374	5	0	3	113	25,181	5	0	3	122	25,499	5	0	3	123
				TSW	23,221	5	0	4	112	25,016	5	0	4	121	25,332	5	0	4	122
				BLC	18,458	2	0	3	89	19,885	2	0	3	96	20,136	2	0	3	97
				LCCO	13,735	2	0	3	66	14,796	2	0	4	71	14,983	2	0	4	72
				RCCO	13,735	2	0	3	66	14,796	2	0	4	71	14,983	2	0	4	72
60	1250	P9	241W	T1S	25,575	3	0	3	106	27,551	3	0	3	114	27,900	3	0	3	116
				T2S	25,548	3	0	4	106	27,522	3	0	4	114	27,871	3	0	4	116
				T2M	25,680	3	0	3	107	27,664	3	0	3	115	28,014	3	0	3	116
				T3S	24,870	3	0	4	103	26,791	3	0	4	111	27,130	3	0	4	113
				T3M	25,617	3	0	4	106	27,597	3	0	4	115	27,946	3	0	4	116
				T4M	25,061	3	0	4	104	26,997	3	0	4	112	27,339	3	0	4	113
				TFTM	25,602	3	0	4	106	27,580	3	0	4	114	27,929	3	0	4	116
				TSVS	26,626	5	0	1	110	28,684	5	0	1	119	29,047	5	0	1	121
				T5S	26,648	4	0	2	111	28,707	5	0	2	119	29,070	5	0	2	121
				T5M	26,581	5	0	3	110	28,635	5	0	3	119	28,997	5	0	3	120
				TSW	26,406	5	0	4	110	28,447	5	0	4	118	28,807	5	0	4	120
				BLC	20,990	2	0	3	87	22,612	2	0	3	94	22,898	2	0	3	95
				LCCO	15,619	2	0	4	65	16,825	2	0	4	70	17,038	2	0	4	71
				RCCO	15,619	2	0	4	65	16,825	2	0	4	70	17,038	2	0	4	71



Performance Data

Lumen Output

Lumen values are from photometric tests performed in accordance with IESNA LM-79-08. Data is considered to be representative of the configurations shown, within the tolerances allowed by Lighting Facts. Contact factory for performance data on any configurations not shown here.

Rotated Optics																			
LED Count	Drive Current	Power Package	System Watts	Dist. Type	30K (3000 K, 70 CRI)					40K (4000 K, 70 CRI)					50K (5000 K, 70 CRI)				
					Lumens	B	U	G	LPW	Lumens	B	U	G	LPW	Lumens	B	U	G	LPW
60	530	P10	106W	T1S	13,042	3	0	3	123	14,050	3	0	3	133	14,228	3	0	3	134
				T2S	12,967	4	0	4	122	13,969	4	0	4	132	14,146	4	0	4	133
				T2M	13,201	3	0	3	125	14,221	3	0	3	134	14,401	3	0	3	136
				T3S	12,766	4	0	4	120	13,752	4	0	4	130	13,926	4	0	4	131
				T3M	13,193	4	0	4	124	14,213	4	0	4	134	14,393	4	0	4	136
				T4M	12,944	4	0	4	122	13,945	4	0	4	132	14,121	4	0	4	133
				TFTM	13,279	4	0	4	125	14,305	4	0	4	135	14,486	4	0	4	137
				TSVS	13,372	3	0	1	126	14,405	4	0	1	136	14,588	4	0	1	138
				T5S	13,260	3	0	1	125	14,284	3	0	1	135	14,465	3	0	1	136
				T5M	13,256	4	0	2	125	14,281	4	0	2	135	14,462	4	0	2	136
				TSW	13,137	4	0	3	124	14,153	4	0	3	134	14,332	4	0	3	135
				BLC	10,906	3	0	3	103	11,749	3	0	3	111	11,898	3	0	3	112
				LCCO	7,789	1	0	3	73	8,391	1	0	3	79	8,497	1	0	3	80
				RCCO	7,779	4	0	4	73	8,380	4	0	4	79	8,486	4	0	4	80
60	700	P11	137W	T1S	16,556	3	0	3	121	17,835	3	0	3	130	18,061	4	0	4	132
				T2S	16,461	4	0	4	120	17,733	4	0	4	129	17,957	4	0	4	131
				T2M	16,758	4	0	4	122	18,053	4	0	4	132	18,281	4	0	4	133
				T3S	16,205	4	0	4	118	17,457	4	0	4	127	17,678	4	0	4	129
				T3M	16,748	4	0	4	122	18,042	4	0	4	132	18,271	4	0	4	133
				T4M	16,432	4	0	4	120	17,702	4	0	4	129	17,926	4	0	4	131
				TFTM	16,857	4	0	4	123	18,159	4	0	4	133	18,389	4	0	4	134
				TSVS	16,975	4	0	1	124	18,287	4	0	1	133	18,518	4	0	1	135
				T5S	16,832	4	0	1	123	18,133	4	0	2	132	18,362	4	0	2	134
				T5M	16,828	4	0	2	123	18,128	4	0	2	132	18,358	4	0	2	134
				TSW	16,677	4	0	3	122	17,966	5	0	3	131	18,193	5	0	3	133
				BLC	13,845	3	0	3	101	14,915	3	0	3	109	15,103	3	0	3	110
				LCCO	9,888	1	0	3	72	10,652	2	0	3	78	10,787	2	0	3	79
				RCCO	9,875	4	0	4	72	10,638	4	0	4	78	10,773	4	0	4	79
60	1050	P12	207W	T1S	22,996	4	0	4	111	24,773	4	0	4	120	25,087	4	0	4	121
				T2S	22,864	4	0	4	110	24,631	5	0	5	119	24,943	5	0	5	120
				T2M	23,277	4	0	4	112	25,075	4	0	4	121	25,393	4	0	4	123
				T3S	22,509	4	0	4	109	24,248	5	0	5	117	24,555	5	0	5	119
				T3M	23,263	4	0	4	112	25,061	4	0	4	121	25,378	4	0	4	123
				T4M	22,824	5	0	5	110	24,588	5	0	5	119	24,899	5	0	5	120
				TFTM	23,414	5	0	5	113	25,223	5	0	5	122	25,543	5	0	5	123
				TSVS	23,579	5	0	1	114	25,401	5	0	1	123	25,722	5	0	1	124
				T5S	23,380	4	0	2	113	25,187	4	0	2	122	25,506	4	0	2	123
				T5M	23,374	5	0	3	113	25,181	5	0	3	122	25,499	5	0	3	123
				TSW	23,165	5	0	4	112	24,955	5	0	4	121	25,271	5	0	4	122
				BLC	19,231	4	0	4	93	20,717	4	0	4	100	20,979	4	0	4	101
				LCCO	13,734	2	0	3	66	14,796	2	0	4	71	14,983	2	0	4	72
				RCCO	13,716	4	0	4	66	14,776	4	0	4	71	14,963	4	0	4	72
60	1250	P13	231W	T1S	25,400	4	0	4	110	27,363	4	0	4	118	27,709	4	0	4	120
				T2S	25,254	5	0	5	109	27,205	5	0	5	118	27,550	5	0	5	119
				T2M	25,710	4	0	4	111	27,696	4	0	4	120	28,047	4	0	4	121
				T3S	24,862	5	0	5	108	26,783	5	0	5	116	27,122	5	0	5	117
				T3M	25,695	5	0	5	111	27,680	5	0	5	120	28,031	5	0	5	121
				T4M	25,210	5	0	5	109	27,158	5	0	5	118	27,502	5	0	5	119
				TFTM	25,861	5	0	5	112	27,860	5	0	5	121	28,212	5	0	5	122
				TSVS	26,043	5	0	1	113	28,056	5	0	1	121	28,411	5	0	1	123
				T5S	25,824	4	0	2	112	27,819	5	0	2	120	28,172	5	0	2	122
				T5M	25,818	5	0	3	112	27,813	5	0	3	120	28,165	5	0	3	122
				TSW	25,586	5	0	4	111	27,563	5	0	4	119	27,912	5	0	4	121
				BLC	21,241	4	0	4	92	22,882	4	0	4	99	23,172	4	0	4	100
				LCCO	15,170	2	0	4	66	16,342	2	0	4	71	16,549	2	0	4	72
				RCCO	15,150	5	0	5	66	16,321	5	0	5	71	16,527	5	0	5	72

FEATURES & SPECIFICATIONS

INTENDED USE

The sleek design of the D-Series Size 1 reflects the embedded high performance LED technology. It is ideal for many commercial and municipal applications, such as parking lots, plazas, campuses, and streetscapes.

CONSTRUCTION

Single-piece die-cast aluminum housing has integral heat sink fins to optimize thermal management through conductive and convective cooling. Modular design allows for ease of maintenance and future light engine upgrades. The LED drivers are mounted in direct contact with the casting to promote low operating temperature and long life. Housing is completely sealed against moisture and environmental contaminants (IP65). Low EPA (1.01 ft²) for optimized pole wind loading.

FINISH

Exterior parts are protected by a zinc-infused Super Durable TGIC thermoset powder coat finish that provides superior resistance to corrosion and weathering. A tightly controlled multi-stage process ensures a minimum 3 mils thickness for a finish that can withstand extreme climate changes without cracking or peeling. Available in both textured and non-textured finishes.

OPTICS

Precision-molded proprietary acrylic lenses are engineered for superior area lighting distribution, uniformity, and pole spacing. Light engines are available in standard 3000 K, 4000 K and 5000 K (70 CRI) configurations. The D-Series Size 1 has zero uplight and qualifies as a Nighttime Friendly™ product, meaning it is consistent with the LEED® and Green Globes™ criteria for eliminating wasteful uplight.

ELECTRICAL

Light engine configurations consist of high-efficacy LEDs mounted to metal-core circuit boards to maximize heat dissipation and promote long life (up to L85/100,000 hours at 25°C). Class 1 electronic drivers are designed to have a power factor >90%, THD <20%, and an expected life of 100,000 hours with <1% failure rate. Easily serviceable 10kV surge protection device meets a minimum Category C Low operation (per ANSI/IEEE C62.41.2).

STANDARD CONTROLS

The DSX1 LED area luminaire has a number of control options. DSX Size 1, comes standard with 0-10V dimming drivers. Dusk to dawn controls can be utilized via optional NEMA twist-lock photocell receptacles. Integrated motion sensors with on-board photocells feature field-adjustable programming and are suitable for mounting heights up to 30 feet.

nLIGHT AIR CONTROLS

The DSX1 LED area luminaire is also available with nLight® AIR for the ultimate in wireless control. This powerful controls platform provides out-of-the-box basic motion sensing and photocontrol functionality and is suitable for mounting heights up to 40 feet. Once commissioned using a smartphone and the easy-to-use CLAIRITY app, nLight AIR equipped luminaires can be grouped, resulting in motion sensor and photocell group response without the need for additional equipment. Scheduled dimming with motion sensor over-ride can be achieved when used with the nLight Eclipse. Additional information about nLight Air can be found here.

INSTALLATION

Included mounting block and integral arm facilitate quick and easy installation. Stainless steel bolts fasten the mounting block securely to poles and walls, enabling the D-Series Size 1 to withstand up to a 3.0 G vibration load rating per ANSI C136.31. The D-Series Size 1 utilizes the AERIS™ series pole drilling pattern (template #8). NEMA photocontrol receptacle are also available.

LISTINGS

UL listed to meet U.S. and Canadian standards. UL Listed for wet locations. Light engines are IP66 rated; luminaire is IP65 rated. Rated for -40°C minimum ambient. U.S. Patent No. D672,492 S. International patent pending.

DesignLights Consortium® (DLC) Premium qualified product and DLC qualified product. Not all versions of this product may be DLC Premium qualified or DLC qualified. Please check the DLC Qualified Products List at www.designlights.org/QPL to confirm which versions are qualified.

International Dark-Sky Association (IDA) Fixture Seal of Approval (FSA) is available for all products on this page utilizing 3000K color temperature only.

BUY AMERICAN

Product with the BAA option is assembled in the USA and meets the Buy America(n) government procurement requirements under FAR, DFARS and DOT. Please refer to www.acuitybrands.com/buy-american for additional information.

WARRANTY

5-year limited warranty. Complete warranty terms located at: www.acuitybrands.com/support/customer-support/terms-and-conditions

Note: Actual performance may differ as a result of end-user environment and application.

All values are design or typical values, measured under laboratory conditions at 25 °C.

Specifications subject to change without notice.





Planning Division
Development Permit Application

Final action on development application or zone change is required within 120 days in accordance with provisions of ORS 227.175

A pre application conference is normally required prior to submittal of an application. Please visit the City's website for submittal requirements

Pre-Application Meeting Date: _____

Incomplete applications will not be scheduled for public hearing until all of the required materials are submitted.

29799 SW Town Center Loop E, Wilsonville, OR 97070
Phone: 503.682.4960 Fax: 503.682.7025
Web: www.ci.wilsonville.or.us

Applicant:

Name: _____
Company: _____
Mailing Address: _____
City, State, Zip: _____
Phone: _____ Fax: _____
E-mail: _____

Authorized Representative:

Name: Mark McKechnie
Company: Oregon Architecture Inc.
Mailing Address: 132 W Main Street, Suite 101
City, State, Zip: Medford, OR 97501
Phone: 541-772-4372 Fax: _____
E-mail: mark@oregonarchitecture.biz

Property Owner:

Name: Wilsonville Retail / Angel LLC
Company: Wilsonville Retail . Angel LLC
Mailing Address: 6454 N Greeley Ave
City, State, Zip: Portland, OR 97217
Phone: 503-525-9100 Fax: _____
E-mail: jangel@pacificstar.biz

Property Owner's Signature:

[Handwritten signature]

Printed Name: _____ Date: _____

Applicant's Signature: (if different from Property Owner)

[Handwritten signature]

Printed Name: _____ Date: _____

Site Location and Description:

Project Address if Available: 29760 SW Boones Ferry Rd, Wilsonville, OR 97070 Suite/Unit _____
Project Location: Vacant lot
Tax Map #(s): 31W14D Tax Lot #(s): 00900 County: [] Washington [x] Clackamas

Request:

This request is for the removal of the 2 existing trees at the northwest corner of the lot which will be in the way of the new proposed public sidewalk.

Project Type: Class I [] Class II [] Class III [x]

[] Residential [x] Commercial [] Industrial [] Other: _____

Application Type(s):

- [] Annexation [] Appeal [] Comp Plan Map Amend [] Parks Plan Review
[] Final Plat [] Major Partition [] Minor Partition [] Request to Modify
[] Plan Amendment [] Planned Development [] Preliminary Plat Conditions
[] Request for Special Meeting [] Request for Time Extension [] Signs [] Site Design Review
[] SROZ/SRIR Review [] Staff Interpretation [] Stage I Master Plan [] Stage II Final Plan
[] Type C Tree Removal Plan [] Tree Permit (B or C) [] Temporary Use [] Variance
[] Villebois SAP [] Villebois PDP [] Villebois FDP [] Other (describe)
[] Zone Map Amendment [] Waiver(s) [] Conditional Use

**RECEIPT (REC22-000154)
FOR CITY OF WILSONVILLE**

BILLING CONTACT

MEGAN MORGAN
Oregon Architecture Inc
132 W Main Street Suite 101, Suite 101
Medford, Or 97501



Payment Date: 03/03/2022

Reference Number	Fee Name	Transaction Type	Payment Method	Amount Paid
TPLN22-0004	DRB Review of Type C Tree Removal Permit Fee	Fee Payment	Credit Card	\$167.00
29760 Sw Boones Ferry Rd Wilsonville, OR 97070			SUB TOTAL	\$167.00
			TOTAL	\$167.00





September 9, 2021

Charles Wilson

Re: Oregon Architecture Inc.
29760 SW Boones Ferry Rd.
Wilsonville, OR 97070

Dear Charles,

Thank you, for sending us the preliminary site plans for this proposed development in Wilsonville OR.

My Company: Republic Services of Clackamas and Washington Counties has the franchise agreement to service this area with the City of Wilsonville. We will provide complete commercial waste removal and recycling services as needed on a weekly basis for this location

The design plans that you sent 9/2/2021 depict the following:

Access onto the property through the entrance/exit apron shared with the neighboring property 29800 SW Boones Ferry Rd. is satisfactory. The anticipated traffic flow pattern for our trucks to exit the site by circling to the left and around the fuel island canopy may be prone to being blocked by customer vehicles. On such an occasion, the option to back our trucks onto the 29800 SW Boones Ferry property will allow a secondary traffic pattern for our trucks to exit the planned site.

The dimensions of the trash and recycle enclosure: 20' wide ID X 11'-4" depth OD with an additional 5'-4" depth OD to allow for personnel entry is satisfactory. The gate swing of 120 degrees, with bottom gates raised to clear landscape curb, and wind pins that hold the gates in the Open and Closed position is satisfactory.

Thanks Charles, for your help and concerns for our services prior to this project being developed.

Sincerely,

A handwritten signature in blue ink, appearing to read "Kelly Herrod", written over a horizontal line.

Kelly Herrod
Operations Supervisor
Republic Services Inc.



**FIRE CODE / LAND USE / BUILDING REVIEW
APPLICATION**

North Operating Center
11945 SW 70th Avenue
Tigard, OR 97223
Phone: 503-649-8577

South Operating Center
8445 SW Elligsen Rd
Wilsonville, OR 97070
Phone: 503-649-8577

REV 6-30-20

Project Information

Applicant Name: Wilsonville Retail / Angel LLC

Address: 6454 N Greeley Ave - 29760 SW Boones Ferry

Phone: 503-525-9100

Email: jangel@pacificstar.biz

Site Address: 29760 SW Boones Ferry Rd

City: Wilsonville

Map & Tax Lot #: 31W14D-00900

Business Name: Wilsonville Convenience Store

Land Use/Building Jurisdiction: City of Wilsonville

Land Use/ Building Permit # DB21-0045 - DB21-0048

Choose from: Beaverton, Tigard, Newberg, Tualatin, North Plains, West Linn, **Wilsonville**, Sherwood, Rivergrove, Durham, King City, Washington County, Clackamas County, Multnomah County, Yamhill County

Project Description

Construction of a new 3,000 SF convenience store with a drive-thru and 12 pump gas station.

Permit/Review Type (check one):

Land Use / Building Review - Service Provider Permit

Emergency Radio Responder Coverage Install/Test

LPG Tank (Greater than 2,000 gallons)

Flammable or Combustible Liquid Tank Installation (Greater than 1,000 gallons)

* Exception: Underground Storage Tanks (UST) are deferred to DEQ for regulation.

Explosives Blasting (Blasting plan is required)

Exterior Toxic, Pyrophoric or Corrosive Gas Installation (in excess of 810 cu.ft.)

Tents or Temporary Membrane Structures (in excess of 10,000 square feet)

Temporary Haunted House or similar

OLCC Cannabis Extraction License Review

Ceremonial Fire or Bonfire (For gathering, ceremony or other assembly)

For Fire Marshal's Office Use Only

TVFR Permit # 2022-0021

Permit Type: SPP-COW

Submittal Date: 2-14-2022

Assigned To: DFM Am

Due Date: NA

Fees Due: Ø

Fees Paid: Ø

Approval/Inspection Conditions
(For Fire Marshal's Office Use Only)

This section is for application approval only

[Signature] 0430 2/23/22

Fire Marshal or Designee Date

Conditions:

See Attached Conditions: Yes No

Site Inspection Required: Yes No

This section used when site inspection is required

Inspection Comments:

NA

Final TVFR Approval Signature & Emp ID Date

AC ASPHALT
 CONC CONCRETE
 E.O.P. EDGE OF PAVEMENT
 DOC. NO. DOCUMENT NUMBER
 SF SQUARE FEET

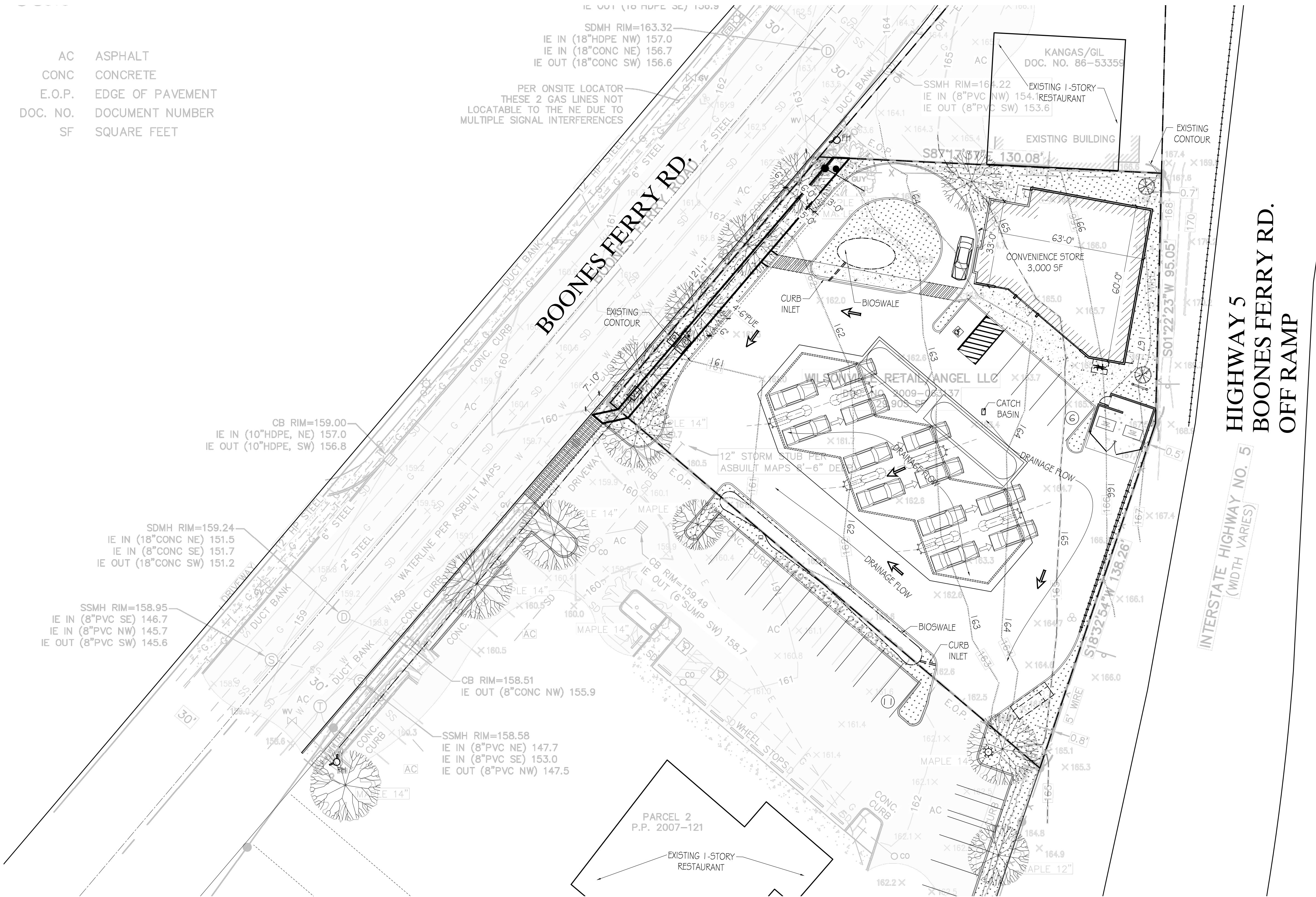

SCHEMATIC SITE PLAN
 SCALE: 1" = 20'-0"

TO VERIFY SCALES 0" 1" BAR SHOULD MEASURE ONE INCH BY ONE SIXTEENTH INCH

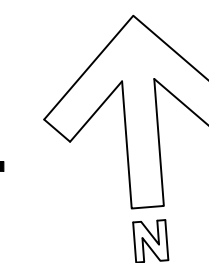

PROJECT DATA

OWNER: TBD
 132 W. Main Street,
 Medford, OR 97501
 541-772-4372

ADDRESS: 29760 Boones Ferry Rd
 Wilsonville, OR 97070

MAP/TAX LOT: 31W14D-00900

ZONING: PDC-Planned Development Commercial
 OVERLAY: Interchange Area Management Plan Overlay
 SETBACK: See Conditional Use Permit Narrative

SITE AREA: 29,905 SF

LOT COVERAGE:
 Building 6,840 SF (23%)
 Landscaping 6,270 SF (21%)
 Paving/concrete 16,795 SF (56%)

PARKING REQUIRED:
 Commercial 4,1/1,000 SF
 Total Car Spaces 13 spaces
 Min. 13/ Max. 19 per Table 5 WDC Section 4.155(.03)G
 (Bike Spaces) (2 spaces)

PARKING PROVIDED: TOTAL
 Standard 5 spaces
 Shared Parking 11 spaces
 Accessible 1 space
 Total 17 spaces
 Bike 2 spaces



APPROVAL OF PLANS IS NOT AN APPROVAL
 OF COMMISSIONS OR OVERSIGHTS.

Jason Marshall
 Deputy Fire Marshal II

TVF&R SPP-COW # 2022-0021

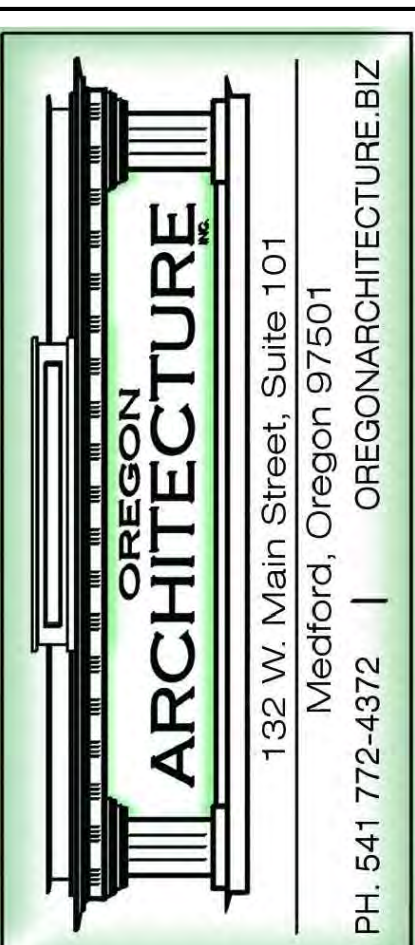

**WILSONVILLE
 CONVENIENCE
 STORE**
 PROJECT LOCATION:
 29760 SW BOONES FERRY RD, WILSONVILLE, OR 97070
 PARCEL: 31W14D-00900

REVISIONS	BY

Approved for the Owner By: _____ Date: _____

PLOT DATE: 01-27-22
 ISSUE DATE: _____
 DRAWN BY: M. MORGAN
 JOB NO.: 4664
 SHEET

FS-1
 SCHEMATIC SITE PLAN

THIS DOCUMENT, THE IDEAS AND THE DESIGNS INCORPORATED HEREIN, IS AN INSTRUMENT OF PROFESSIONAL SERVICE AND PROPERTY OF OREGON ARCHITECTURE INC., AND IS NOT TO BE USED IN WHOLE OR IN PART, FOR ANY OTHER PROJECT, WITHOUT THE WRITTEN AUTHORIZATION OF OREGON ARCHITECTURE INC., COPYRIGHT 2021.

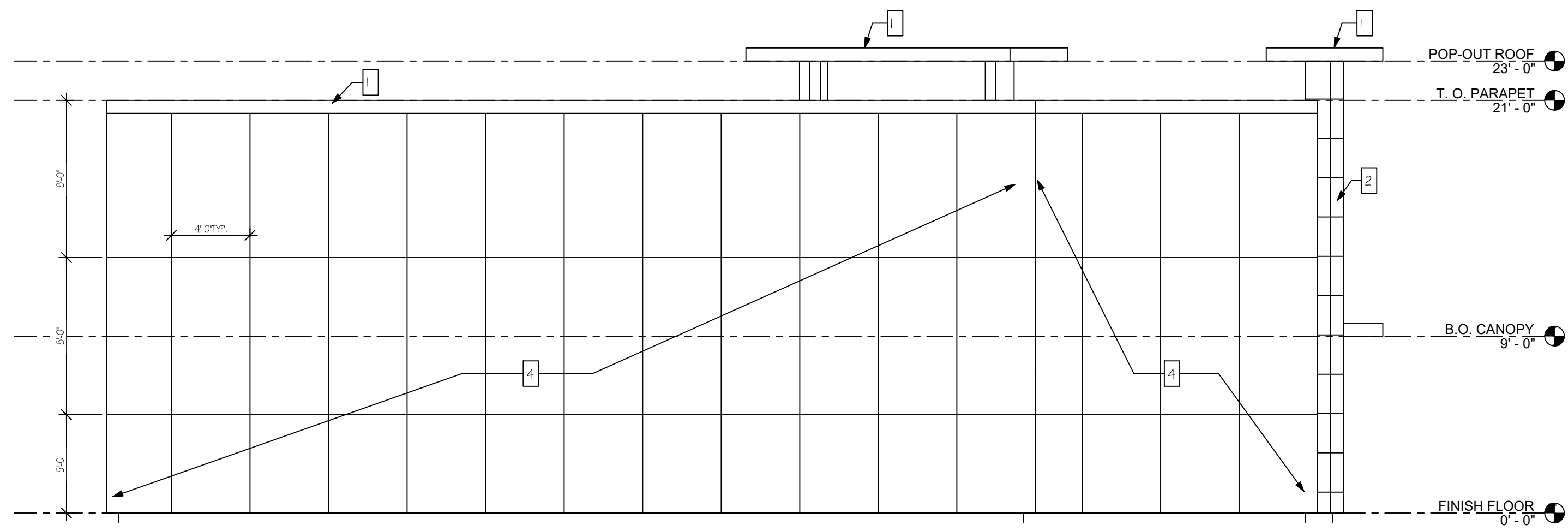

NORTH SCHEMATIC ELEVATION

SCALE : 3/16" = 1'-0"

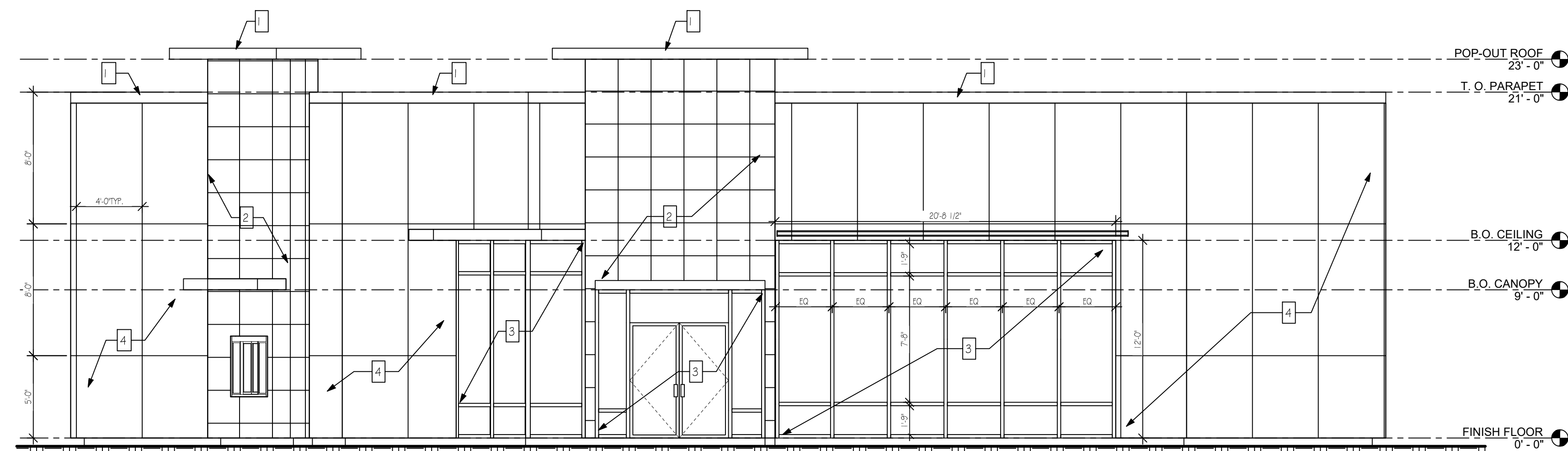

SOUTH SCHEMATIC ELEVATION

SCALE : 3/16" = 1'-0"

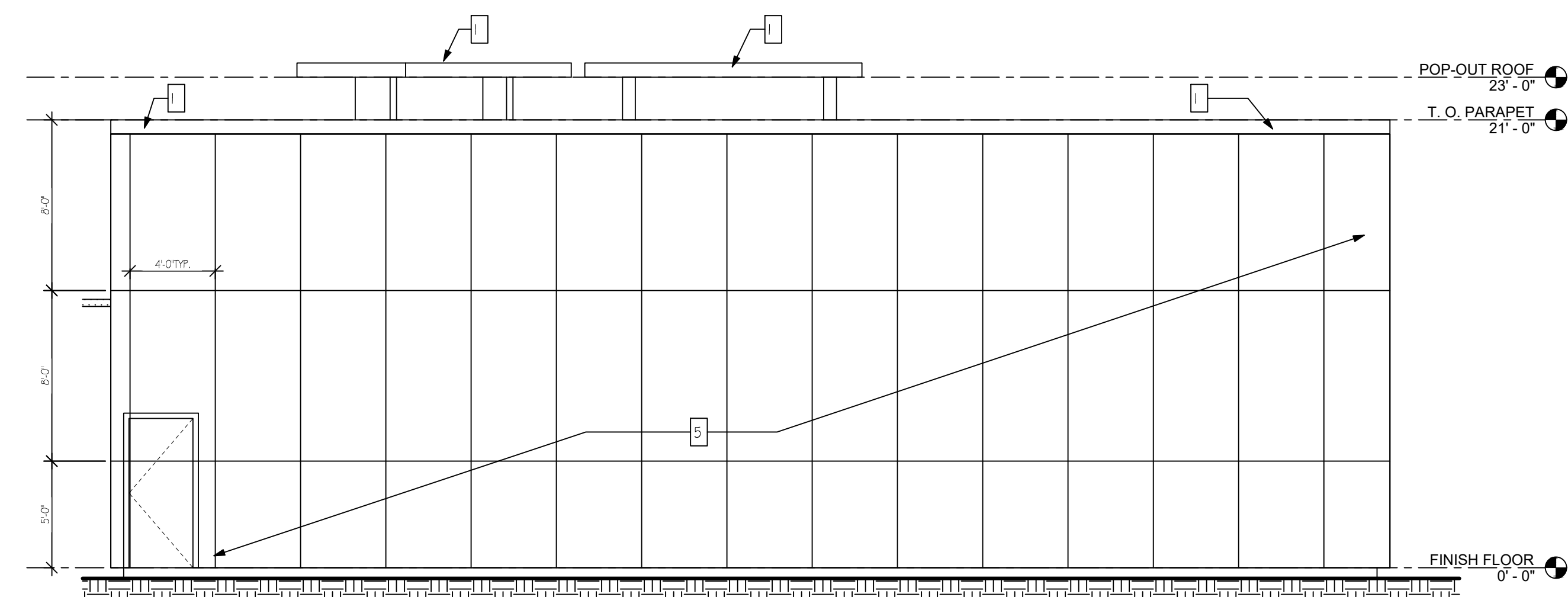

EAST SCHEMATIC ELEVATION

SCALE : 3/16" = 1'-0"

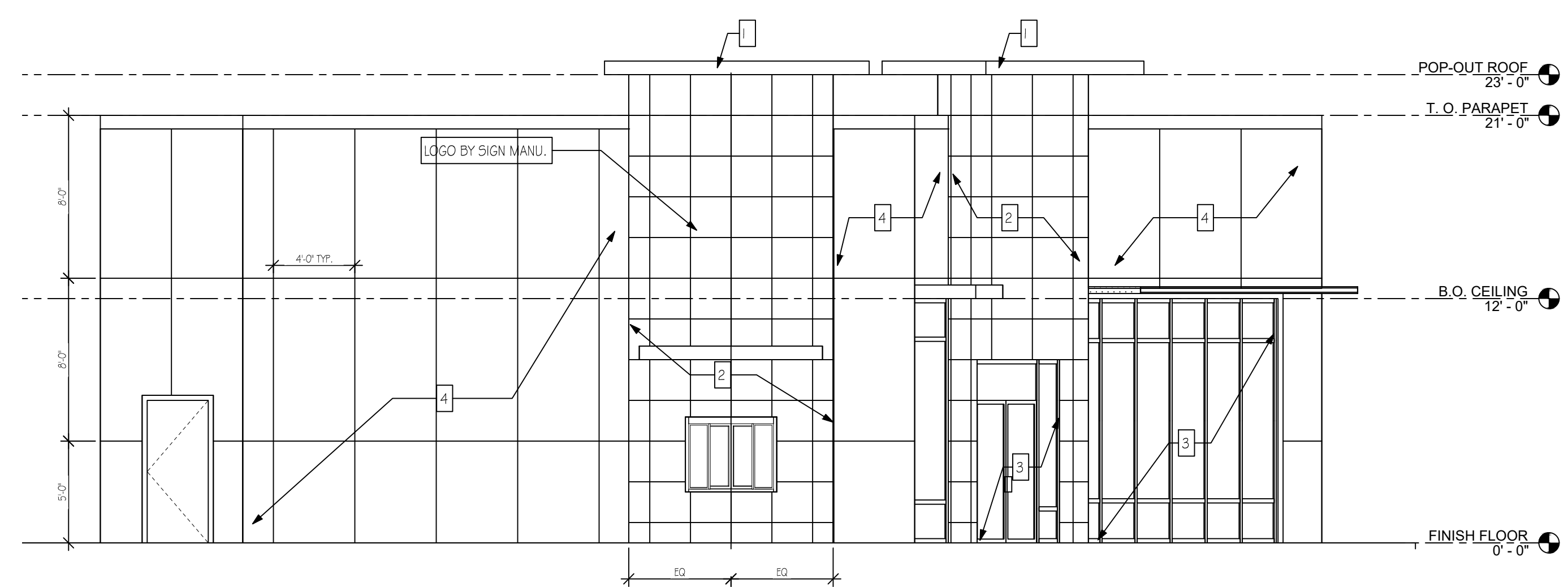

WEST SCHEMATIC ELEVATION

SCALE : 3/16" = 1'-0"

KEYNOTES:

- 1 - BONE WHITE ROOF METAL EDGE
- 2 - HARDIE MULTI-GROOVE FIBER CEMENT PANELS; COLOR: TIMBER BARK
- 3 - ALUM. FRAME & MULLIONS
- 4 - HARDIE MULTI-GROOVE FIBER CEMENT PANELS; COLOR: COBBLE STONE
- 5 - HARDIE MULTI-GROOVE FIBER CEMENT PANELS; COLOR: ARCTIC WHITE



APPROVED PLANS

APPROVAL OF PLANS IS NOT AN APPROVAL OF OMISSIONS OR OVERSIGHTS.

Jason Durr
Deputy Fire Marshal II

TVF&R SPP-COW # 2022-0021



OREGON ARCHITECTURE
132 W. Main Street, Suite 101
Medford, Oregon 97501
PH. 541 772-4372 | OREGONARCHITECTURE.BIZ

WILSONVILLE CONVENIENCE STORE
PROJECT LOCATION: 29760 SW BOONES FERRY RD, WILSONVILLE, OR 97070
PARCEL: 31W14D-00900

Approved for the Owner By: _____ Date: _____

REVISIONS	BY

PLOT DATE: 01-27-22
ISSUE DATE: _____
DRAWN BY: M. MORGAN
JOB NO.: 4664
SHEET

FS-2
SCHEMATIC ELEVATIONS

TO VERIFY SCALES 0" 1" BAR SHOULD MEASURE ONE INCH BY ONE SIXTEENTH INCH

THIS DOCUMENT, THE IDEAS AND THE DESIGNS INCORPORATED HEREIN, IS AN INSTRUMENT OF PROFESSIONAL SERVICE AND PROPERTY OF OREGON ARCHITECTURE INC., AND IS NOT TO BE USED IN WHOLE OR IN PART, FOR ANY OTHER PROJECT, WITHOUT THE WRITTEN AUTHORIZATION OF OREGON ARCHITECTURE INC., COPYRIGHT 2021.

17
5M
127

Clackamas County Official Records
Sherry Hall, County Clerk

2011-021360

When Recorded Return To:
Ball Janik LLP
101 SW Main Street, Suite 1100
Portland, Oregon 97204
Attn: Christopher M. Walters



\$152.00

04/07/2011 11:31:35 AM

D-E Cnt=2 Stn=9 DIANNAW
\$85.00 \$5.00 \$16.00 \$16.00 \$10.00 \$20.00

RECIPROCAL EASEMENT AND LICENSE AGREEMENT

EFFECTIVE DATE: December 6, 2010

AMONG: WILSONVILLE RETAIL/ANGEL, LLC,
an Oregon limited liability property ("WR")

AND: WILSONVILLE/ANGEL, LLC,
an Oregon limited liability company ("WA")

AND: BOONES FERRY/ANGEL LLC,
an Oregon limited liability company ("BF")

Recitals:

A. WR owns the real property described in the attached Exhibit A-1 ("North Parcel"). WA owns the property described in Exhibit A-2 ("Middle Parcel"). BF owns the property legally described in Exhibit A-3 hereto ("South Parcel"). The three parcels (the "Parcels" and collectively, the "Property") are adjacent, and border Boones Ferry Road in Wilsonville, Oregon. The owner of each Parcel is referred to as an "Owner."

B. The Owners desire to (i) grant and declare reciprocal easements over curb cuts from Boones Ferry Road, over and across those portions, and only those portions, of the Parcels shown on Exhibit B hereto (the "Driveways"), for the purpose of vehicular access over and across drive aisles to and from the Parcels; (ii) grant licenses permitting access over the Driveways and any other drive aisles at the Parcels, to park on those portions of the Parcels which are, from time to time, designated for parking (the "Parking Areas"), and for pedestrian access over and from such Parking Areas to buildings located on each of the Parcels and to public right of ways and (iii) impose covenants and conditions regarding the maintenance, repair, replacement and recovery of expenses relating to the Property, all on the terms and conditions of this Reciprocal Easement and License Agreement (this "Agreement").

Agreements:

In consideration of the foregoing, the mutual covenants of the parties contained in this Agreement, and other good and valuable consideration, the receipt and adequacy of which are hereby acknowledged, the parties, intending to be legally bound, agree as follows:

1. **Declaration of Vehicular Access Easements.** Subject to the restrictions, covenants, and conditions set forth in this Agreement, the Owners hereby declare and create, for the benefit of all existing and future Owners of any portion of the Property and their respective tenants, customers, employees, contractors and other invitees ("Permitted Users"), a non-exclusive, perpetual easement over and across the Driveways for the purpose of access, ingress and egress to and from each such Owner's portion of the Property and to public right of ways, including without limitation access to and from all curb cuts along Boones Ferry Road.

2. **Rights and Restrictions.** Each Permitted User's use of the Driveways shall avoid interference to the use of the Driveways by every other Permitted User, and each Owner and its Permitted Users shall be prohibited from: (i) blocking, obstructing, or placing any unreasonable barrier on the Driveways, except in the event of emergencies or as required by law or (ii) using any portions of the Driveways which are not reasonably necessary or convenient for the limited purpose of obtaining access, ingress and egress to and from the portion of the Property owned by each such Owner. Each Owner and its Permitted Users shall act in good faith and use reasonable efforts to allow the mutual benefit arising from the use of, and the right of access, ingress and egress over and across, the Driveways.

3. **Site Improvements.**

3.1 **Site Manager.** So long as any Parcel is owned by WR, WA, or BF ("Current Owners"), the Current Owner (or the remaining of such Current Owners that then own Parcels, acting collectively) shall have the right, but not the obligation, to appoint, change, and discharge one or more persons or entities (the "Site Manager"), for the purposes set forth in this Agreement. If the Current Owners do not designate a Site Manager (which may be a Current Owner or a third party), then the Current Owners collectively may exercise the rights of the Site Manager.

3.2 **Approval Required.** For so long as any Current Owner owns a Parcel, except as otherwise provided herein, the construction, demolition, alteration or relocation of building footprint, driveways, parking areas, landscaping and signage ("Site Improvements") on each Owner's Parcel shall be subject to the prior written approval of the Site Manager, and no Site Improvements shall be constructed, demolished, altered, or relocated without the prior written approval of the Site Manager. For purposes of this Section, drive aisles, walkways, parking lot striping, paving and seal coating is included in the scope of the Site Improvements subject to such review and approval.

3.3 **Submission of Plans.** Unless the Site Manager approves otherwise, before the initiation of construction of Site Improvements, the Owner thereof shall first submit to the

Site Manager a complete set of plans and specifications for the proposed Improvements, including site plans, grading plans, landscape plans, striping plans, and any other information deemed necessary by the Site Manager for the performance of its approval function. In addition, the Owner shall submit the identity of the individual or company intended to perform the work and projected commencement and completion dates.

3.4 Plan Review. Upon receipt by the Site Manager of all of the information required by this Article, it shall have thirty (30) days in which to review said plans or to request any missing information or documentation. The Site Manager may require as a condition of its review that the submitting Owner remit to the Site Manager, in advance, a review fee established by the Site Manager to defray the Site Manager's anticipated costs of review, including time and expenses incurred by or fees paid to any architectural, engineering or legal professional engaged for the purpose of such review. If the Site Manager fails to issue its written approval, rejection, or request for additional data within thirty (30) days of its receipt of what is identified by the Owner as the last of the materials or documents required to complete the Owner's submission, the Site Manager's approval shall be deemed to have been granted without further action. In no event shall the Site Manager's thirty-day review period commence prior to the date on which Owner has submitted the last of any documents or information required to complete the application.

3.5 Non-conforming Improvements. If there shall be a material deviation from the approved plans in the completed Site Improvements, such Site Improvements shall be in violation of this Agreement to the same extent as if erected without prior approval of the Site Manager. In addition to their other rights, the Current Owner(s) may maintain an action at law or in equity for the removal or correction of the non-conforming structure and, if successful, shall recover from the Owner in violation all costs, expenses and fees, including without limitation attorney fees, incurred in the prosecution thereof.

3.6 Immunity. No Site Manager or Current Owner shall have any personal liability to any Owner or any other person for acts or omissions committed in good faith and without malice.

3.7 Role of Site Manager. The Site Manager shall not act in the capacity of settling disputes between Owners or resolving problems that Owners may experience. Disputes or problems experienced by Owners with respect to which the Site Manager has no express authority or role as set forth in this Declaration shall be resolved by private, lawful means chosen by the affected Owners and there shall be no recourse to the Site Manager.

3.8 Limited Authority of Site Manager. Approval by the Site Manager of any submittal is not to be construed as compliance with applicable laws, codes or permits, or approval by any governmental agency having jurisdiction over the construction of improvements. The applicant is responsible for determining the need, obtaining, and complying with, any governmental agency approval or permit.

3.9 Parking Spaces. So long as any Current Owner owns a Parcel, each other Owner shall construct and stripe the parking areas on its Parcel in a manner that maximizes and preserves the number of allocable parking spaces permitted under the Parking Master Plan, as approved in advance by the Site Manager, given the proposed use of such Parcel, the constraints of the site, the approved building footprint, and applicable legal access requirements. This provision does not require the construction of parking structures. The "Parking Master Plan" shall mean the provisions of the land use approvals then in effect for the Property regarding minimum and maximum parking spaces, as such approvals may be amended from time to time. In addition, because the current Parking Master Plan establishes cumulative parking space standards for the Property in addition to standards applicable to each Parcel, so long as any current Owner owns a Parcel, no Owner may construct or stripe on its Parcel a number of parking spaces that the Site Manager determines includes an inappropriate allocation of parking spaces to such Parcel.

3.10 Exemption. The foregoing provisions of this Section 3 do not apply to any Current Owner or the former or future Site Improvements constructed, demolished, altered or relocated by any Current Owner.

3.11 Approval Letters. Within 30 days after the written request of any Owner, the Site Manager shall submit to such Owner a letter identifying whether any particular constructed Site Improvement identified by such Owner has achieved approval (or that such approval was not required) under this Section 3. Any lender, tenant, or subsequent purchase may rely upon such letter in confirming whether particular Site Improvements conform to the requirements of this Section 3. The costs and fees of the Site Manager in processing such request shall be reimbursed by such Owner in accordance with Section 3.4.

3.12 After Current Owners. At such time as no Current Owner any longer owns a Parcel, then the foregoing approval standards shall no longer apply to future construction, and instead the future construction, demolition, alteration or relocation of Site Improvements shall not materially impair the access, ingress and egress to, through, and from any other Owner's portion of the Property, or cause any portion of the Property to be in violation of any federal, state or local law, ordinance, rule, regulation, or land use approval.

3.13 Open Access. In connection with any construction or relocation of Site Improvements, the Owner performing the construction shall not cause the blockage of any more than one of the three means of vehicular access over curb cuts to S.W. Boones Ferry Road, so that each other Owner's Parcel at all times has vehicular access to S.W. Boones Ferry Road during the course of construction.

4. Parking.

4.1 License. Subject to the rights and restrictions set forth in this Agreement, each Owner grants to the other Owners, and to their Permitted Users who are tenants or occupants of buildings on such other Owners' Parcels, a nonexclusive license (i) to vehicular access to, and the right to park on, those portions, and only those portions, of the granting

Owner's Property which are, from time to time, improved and designated for parking purposes, which access shall be over the Driveways and such other drive aisles as are located from time to time on the Parcels and (ii) of pedestrian access over sidewalks at the Parcels for the purpose of accessing such parked vehicles and access to public right of ways. No Owner shall impose a fee or charge for this license. This license does not create any obligation to construct or reconstruct parking areas on any Parcel within any particular time, provided any parking areas constructed shall comply with the requirements of Section 3, and provided further the parking spaces on each Parcel, and mutual access to such spaces, taken in combination with other parking spaces covered by the Parking Master Plan, remain in conformance with the Parking Master Plan and applicable laws. Each Owner and its Permitted Users shall act in good faith and use reasonable efforts to allow the mutual benefit arising from the use of this license.

4.2 Restrictions. So long as any Current Owner owns a Parcel, the Site Manager may impose and revise written rules and regulations governing parking at the Parcels, with which all Owners shall comply upon receipt of such rules and regulations ("Parking Rules and Regulations"). The Parking Rules and Regulations may, among other things, set the terms and conditions of, restrict, or prohibit, reserved spaces, the size and width of spaces, maximum vehicle sizes, overnight parking, and employee parking. The Site Manager may enforce violations of the Parking Rules and regulations by any and all means, including injunctive relief and self-help, and may impose and collect reasonable daily fines for any such violations.

5. Maintenance and Repair.

5.1 General. Except as otherwise provided in this Section 5, each Owner shall be solely responsible for the maintenance and repair of all improvements on such Owner's Parcel, without contribution from the other Owners; provided that each Owner shall be responsible for and shall pay for the cost of repair or replacement of any damage to any such improvements which results from the negligence or willful misconduct of such Owner or its Permitted Users.

5.2 Standards. Each Owner shall maintain, repair, replace, reconstruct, and keep in a clean and safe condition, as may be appropriate, the driveways, sidewalks, landscaping, external signage, and parking areas on its Parcel ("Maintenance Areas") in accordance with generally accepted standards then existing for similar property in Wilsonville, Oregon ("Maintenance"). Required Maintenance shall include, without limitation, the following:

5.2.1. Maintaining, repairing, replacing and keeping in good condition all paved surfaces; including without limitation seal coating at least once each seven years, and replacement or repaving at least each fifteen years;

5.2.2. Maintaining, repairing, replacing and keeping in good condition all curbing;

5.2.3. Removing all papers, debris, filth, and refuse, from the Maintenance Areas;

5.2.4. Washing or sweeping paved areas as reasonably required; and

5.2.5. Repairing and repainting striping, markers, directional signs, and all other similar markings as reasonably required.

5.3 Site Manager. So long as any Parcel is owned by the Current Owners, the Site Manager (or the remaining of such Current Owners that then own Parcels, acting collectively) shall have the right, but not the obligation, to arrange performance of some or all Maintenance on the entire Property ("Collective Maintenance"). Each Owner grants the Site Manager and its designated contractors an irrevocable license, upon not less than 24 hours notice, to enter upon such Owner's Parcel to inspect such Parcel for necessary Maintenance and to perform Maintenance. This right is intended to be for the benefit of the Current Owners, and neither any of such Current Owners nor the Site Manager shall have any liability to other Owners for Collective Maintenance or for any alleged deficient or defective Collective Maintenance. At any time, the Current Owners may relinquish their right to perform Collective Maintenance, in which case each Owner shall perform such Maintenance on its own Parcel in accordance with Sections 5.1 and 5.2.

5.4 Reimbursement of Repair and Maintenance Expenses. For so long as there is a Site Manager, the cost of Collective Maintenance by the Site Manager and its contractors shall be shared by and reimbursed by the Owners on such basis as the Site Manager shall reasonably determine. Such cost may include a management fee paid to the Site Manager consistent with then-market rates. It shall be deemed reasonable for the Site Manager to allocate expenses based on the respective percentage ground areas of the Parcels ("Ground Percentages"), which on this date are deemed to be 24% North Parcel, 53% Middle Parcel, and 23% South Parcel. At such time as there is no Site Manager, the Cost of Collective Maintenance shall be shared by the Owners in accordance with their respective Ground Percentages unless all Owners agree otherwise. The Current Owner who incurs such costs shall have a right to reimbursement from the other Owners within thirty (30) days of request therefor, which reimbursement request shall include copies of all paid invoices and a statement of each Owner's share of such Collective Maintenance costs.

5.5 Cooperation. In performing Maintenance, the Owners shall cooperate with each other and endeavor to avoid interference with the operation of business conducted on the other Owners' property.

5.6 Collection. If any Owner fails to promptly pay any amount due under this Agreement within thirty (30) days of written request therefor, including its share of costs of Collective Maintenance by the Site Manager, interest shall accrue upon such unpaid amounts at 12% per annum, and the Owner owed such amounts may commence a collection action in Multnomah County or any other court having jurisdiction. In addition, a lien is granted against

the property of the Owner failing to pay its share of Collective Maintenance costs, in favor of the Owner owed such sums, which lien may be foreclosed by suit, power of sale, or in any other manner permitted by applicable law. Any lien granted under this Section shall automatically be subordinate to any mortgage or deed of trust now or hereafter placed on an Owner's property, and to all renewals, modifications, consolidations and replacements of such mortgages or deeds of trust, except mortgages or deeds of trust granted to an affiliate of the Owner.

6. Liability; Indemnification; Insurance.

6.1 Limitations on Liability. No Owner, nor its agents, principals, tenants or employees shall have any liability to any other Owner or such other Owner's Permitted Users for the condition of any improvements on the Owner's Parcel.

6.2 Indemnification. Each Owner shall indemnify, defend, protect and hold harmless the other Owner's from and against any and all claims, demands, damages, losses, liabilities, and expenses (including reasonable attorneys' fees) arising out of the use of the easement and license granted hereby by such Owner's Permitted Users.

6.3 Insurance. Each Owner shall maintain public liability insurance for accidents or injuries with respect to operations on its Parcel, which insurance shall cover claims arising out of accidents and injuries on the other Parcels related to use of the easement and/or license herein by any of such Owner's Permitted Users. Each Owner shall provide evidence of such coverage to any other Owner upon request.

7. Prior Plats and Grants.

7.1 To the extent Exhibit B, or any other recorded instrument, plat or survey of any portion of the Property, designates or shows any of the access easements described herein between or among the Parcels, the easements so designated be subject to the terms and conditions of this Agreement.

7.2 This Agreement is not intended to terminate or limit any prior easement granted upon or for the benefit of any of the Parcels. Without limitation, the applicable Parcels retain their appurtenant rights under that certain Reciprocal Easement and License Agreement recorded May 21, 1996 as document number 96-036599, Clackamas County Records.

7.3 At the request of any Owner who has permissibly relocated a Driveway on its property pursuant to this Agreement, the other Owners shall, at the request of Owner, execute such amendments to documents as are requested to show the modified location of the Driveway.

8. Miscellaneous Provisions.

8.1 Easement to Run with Land; Binding Effect. The easements granted pursuant to this Agreement shall run with the land as to all property benefited and burdened thereby under this Agreement, including any partition or division of such property. The rights, covenants, and obligations contained in this Agreement shall bind, burden, and benefit the

Owners and their respective heirs, devisees, successors, assigns, tenants, mortgagees, and beneficiaries under any deeds of trust.

8.2 Condemnation. In the event that all or any part of the Property is condemned, or is conveyed to a public authority under bona fide threat of condemnation, this Agreement shall automatically terminate and be of no further force and effect with respect to the property so condemned or conveyed. In the event that any such condemnation or conveyance renders the easement area unusable for its intended use under this Agreement, this Agreement shall also automatically terminate with respect to the easement area so affected, provided the Owner of the encumbered parcel shall use reasonable efforts in such case to relocate the easement to a different remaining portion of such Owner's Parcel to the extent commercially feasible. Except to the extent expressly provided in this Section 7.2, the rights and obligations of the parties pursuant to this Agreement shall be unaffected and remain in full force and effect notwithstanding any such condemnation or conveyance.

8.3 Notices. Notices under this Agreement shall be in writing and may be delivered personally, delivered by national overnight delivery service, transmitted by facsimile, or delivered by United States mail, postage prepaid with return receipt requested, addressed to such Owner's Parcel or to such other address as the Owner may indicate by written notice to the other Owners. Any notice so delivered shall be deemed given when actually received or, if earlier, (i) in the case of facsimile transmission, on the date on which the transmitting party receives confirmation of receipt by telecopy, telephone, or otherwise, (ii) in the case of delivery by national overnight delivery service, on the next business day or the day designated for delivery, or (iii) in the case of U.S. mail, three business days after deposit therein.

8.4 Waiver. Failure of any party at any time to require performance of any provision of this Agreement shall not limit such party's right to enforce such provision, nor shall any waiver of any breach of any provision of this Agreement constitute a waiver of any succeeding breach of such provision or a waiver of such provision itself.

8.5 Amendment. This Agreement may not be modified or amended except by the written agreement of the parties, recorded in the real property records of Clackamas County, Oregon.

8.6 Attorneys' Fees. If a suit, action, or other proceeding of any nature whatsoever (including any proceeding under the U.S. Bankruptcy Code) is instituted in connection with any controversy, collection or foreclosure action arising out of this Agreement or to interpret or enforce any rights hereunder, the prevailing party shall be entitled to recover its attorneys' fees and all other fees, costs, and expenses actually incurred and reasonably necessary in connection therewith, as determined by the court at trial or on any appeal or review, in addition to all other amounts provided by law.

8.7 Severability. If any provision of this Agreement is found by a court of competent jurisdiction to be invalid or unenforceable as written, then (i) such provision shall be

enforceable to the fullest extent permitted by law, and (ii) the invalidity or unenforceability of such provision shall not affect the validity and enforceability of the remainder of this Agreement.

8.8 Integration. This Agreement contains the entire agreement and understanding of the parties with respect to the subject matter hereof and supersedes all prior and contemporaneous agreements between them with respect thereto.

8.9 Construction and Interpretation. The headings or titles of the sections of this Agreement are intended for ease of reference only and shall have no effect whatsoever on the construction or interpretation of any provision of this Agreement. As used herein, the term "including" is not limiting and means "including without limitation." All provisions of this Agreement have been negotiated at arm's length and this Agreement shall not be construed for or against any party by reason of the authorship or alleged authorship of any provision hereof.

8.10 Counterparts. This Agreement may be executed in any number of counterparts, all of which together shall constitute one and the same agreement.

8.11 Governing Law. This Agreement shall be governed by and construed in accordance with the laws of the State of Oregon (without regard to the principles thereof relating to conflicts of laws).

IN WITNESS WHEREOF, the parties have executed this Agreement as of the date first set forth above.

WR:

WILSONVILLE RETAIL/ANGEL, LLC,
an Oregon limited liability property

By: _____
Its: MEMBER

WA:

WILSONVILLE/ANGEL, LLC,
an Oregon limited liability company

By: _____
Its: MEMBER

BF:

BOONES FERRY/ANGEL LLC,
an Oregon limited liability property

By: _____
Its: MEMBER

STATE OF OREGON)
) ss.
County of Multnomah)

This instrument was acknowledged before me on DECEMBER 9, 2010 by
JOSEPH W. ANGEL as MEMBER of
WILSONVILLE RETAIL/ANGEL, LLC.



Trina Guinn
Notary Public for Oregon
My Commission Expires 1/12/2013

STATE OF OREGON)
) ss.
County of Multnomah)

This instrument was acknowledged before me on DECEMBER 9, 2010 by
JOSEPH W. ANGEL as MEMBER of
WILSONVILLE/ANGEL, LLC.



Trina Guinn
Notary Public for Oregon
My Commission Expires 1/12/2013

STATE OF OREGON)
) ss.
County of Multnomah)

This instrument was acknowledged before me on DECEMBER 9, 2010 by
JOSEPH W. ANGEL as MEMBER of BOONES
FERRY/ANGEL LLC.



Trina Guinn
Notary Public for Oregon
My Commission Expires 1/12/2013

EXHIBIT A-1

**LEGAL DESCRIPTION OF
NORTH PARCEL**

A tract of land situated in the Southeast one-quarter of Section 14, Township 3 South, Range 1 West of the Willamette Meridian, in the City of Wilsonville, County of Clackamas and State of Oregon, being more particularly described as follows:

Beginning at a point opposite and 100.00 feet Westerly of Station 531+00 on the centerline of the South bound lane of the Pacific Highway (Interstate No. 5) said point bears South $89^{\circ}57'47''$ West 1,414.87 feet and North $00^{\circ}02'52''$ West 598.60 feet from the Southeast corner of said Section 14; thence North $00^{\circ}11'21''$ West following the Westerly right-of-way line of said Pacific Highway, 95.05 feet to the Southeast corner of that certain property conveyed to Phillip R. Balsiger and Donna Mae Balsiger and described by Deed recorded June 10, 1968 as Fee No. 68-010801; thence North $88^{\circ}49'34''$ West following the South line of said Balsiger property 129.94 feet to a point on the Southeasterly right-of-way line of Boones Ferry Road (Market Road No. 27); thence South $38^{\circ}46'23''$ West following said right-of-way line 122.97 feet; thence South $51^{\circ}13'37''$ East 214.14 feet to a point on the Westerly right-of-way line of said Pacific Highway; thence North $16^{\circ}56'21''$ East following said right-of-way line 138.28 feet to the point of beginning.

EXHIBIT A-2

**LEGAL DESCRIPTION OF
MIDDLE PARCEL**

Parcel 2, PARTITION PLAT NO. 2007-121, in the City of Willsonville, County of Clackamas and State of Oregon.

EXHIBIT A-3

**LEGAL DESCRIPTION OF
SOUTH PARCEL**

Parcel 1, PARTITION PLAT NO. 2007-121, in the City of Wilsonville, County of Clackamas and State of Oregon.

EXHIBIT B
DRIVEWAY EASEMENT LOCATIONS

EXHIBIT B

(the "Driveways")

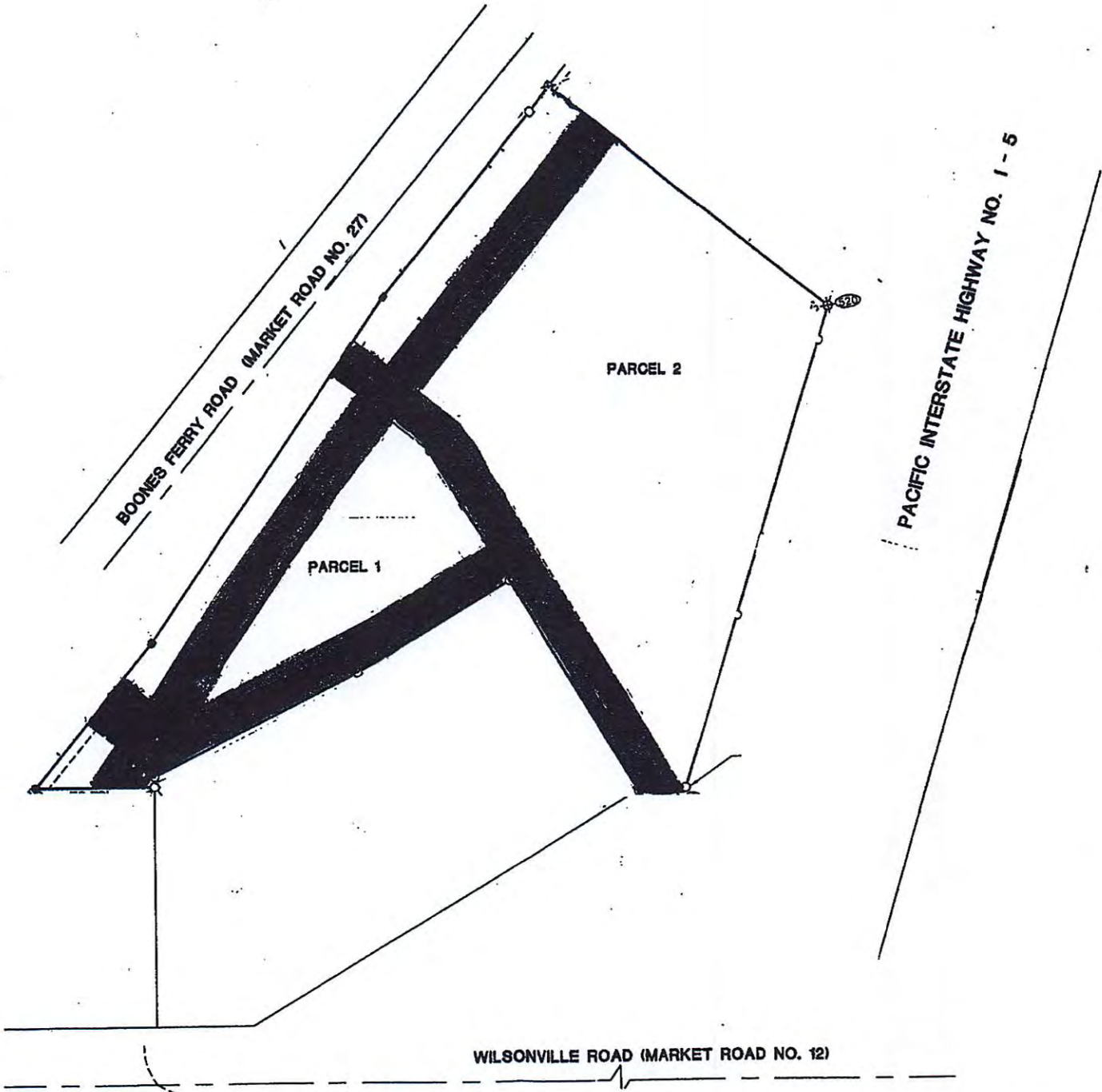

PARTITION PLAT NO. 2007.121

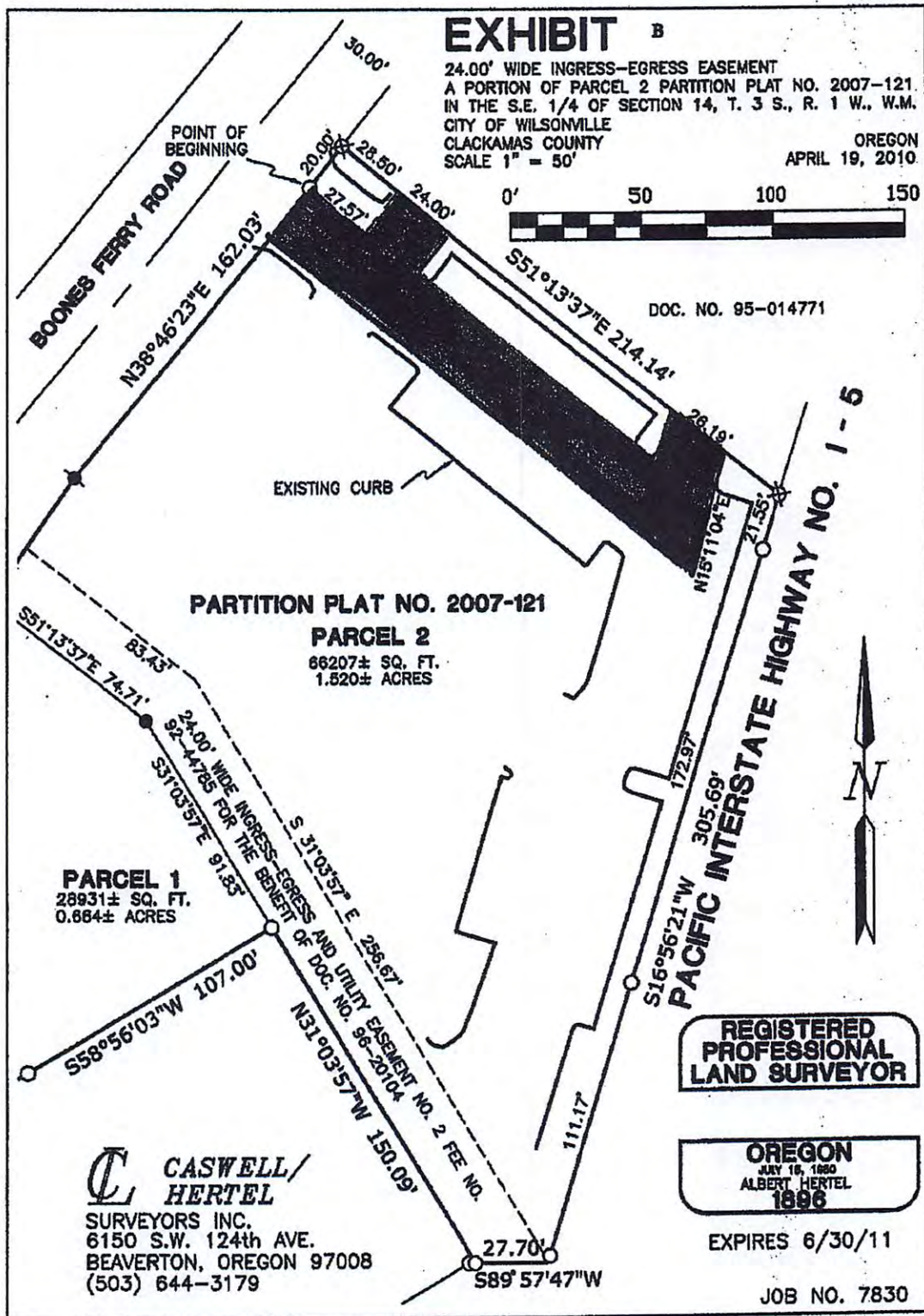

16

**CASWELL / HERTEL
SURVEYORS, INC.**

Professional Land Surveyors
info@chsurveyinc.com

6150 S.W. 124th Avenue
Beaverton, Oregon 97008-4724

Telephone 503/644-3179
Fax 503/644-3190

**LEGAL DESCRIPTION
24.00' WIDE INGRESS-EGRESS EASEMENT**

April 19, 2010

A TRACT OF LAND IN THE SOUTHWEST 1/4 OF THE SOUTHEAST 1/4 OF SECTION 14, TOWNSHIP 3 SOUTH, RANGE 1 WEST OF THE WILLAMETTE MERIDIAN, COUNTY OF CLACKAMAS, STATE OF OREGON, BEING A PORTION OF PARCEL 2 PARTITION PLAT NUMBER 2007-121 A DULY RECORDED PLAT IN CLACKAMAS COUNTY RECORDS AND BEING MORE PARTICULARLY DESCRIBED AS FOLLOWS:

BEGINNING AT A 5/8 INCH IRON ROD WITH YELLOW PLASTIC CAP INSCRIBED CASWELL PLS 737 SET ON THE NORHTWESTERLY LINE OF SAID PARCEL 2, SAID IRON ROD BEARS S38°46'23"W 20.00 FEET FROM A 5/8 INCH IRON ROD WITH YELLOW PLASTIC CAP INSCRIBED "CASWELL PLS 737 AT THE MOST NORTHERLY CORNER OF SAID PARCEL 2; THENCE ALONG THE NORTHWESTERLY LINE OF PARCEL 2 S38°46'23"W 24.00 FEET TO A POINT; THENCE S51°19'15"E 206.96 FEET TO A POINT; THENCE N15°11'04"E 47.65 FEET TO A POINT ON THE NORTHEASTERLY LINE OF SAID PARCEL 2; THENCE ALONG SAID NORTHEASTERLY LINE OF SAID PARCEL 2 N51°13'37"W 26.19 FEET TO A POINT; THENCE LEAVING SAID NORTHEASTERLY LINE OF PARCEL 2 S15°11'04"W 21.52 FEET TO A POINT; THENCE N51°19'15"W 118.75 FEET TO A POINT; THENCE N38°34'30"E 19.92 FEET TO A POINT ON THE NORTHEASTERLY LINE OF SAID PARCEL 2; THENCE ALONG SAID NORTHEASTERLY LINE OF PARCEL 2 N51°13'37"W 24.00 FEET TO A POINT; THENCE LEAVING SAID NORTHEASTERLY LINE OF PARCEL 2 S38°34'30"W 19.96 FEET TO A POINT; THENCE N51°19'15"W 27.57 FEET TO THE POINT OF BEGINNING, HAVING AN AREA OF 5836 SQUARE FEET.

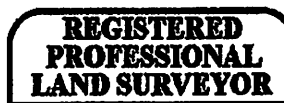

EXPIRES 06/30/2011

JOB NO. 7830

B-4

::ODMAPCDOCS\PORTLAND\7128685

17

When recorded return to:

Evan H. Lenneberg
Brix Law LLP
75 SE Yamhill St, Suite 202
Portland, Oregon 97214

PARTY LINE STORM WATER SEWER EASEMENT

THIS PARTY LINE STORM WATER SEWER EASEMENT (this "Easement ") is made as of _____, 2022, by Wilsonville/Angel LLC, an Oregon limited liability company ("Grantor"), and Wilsonville Retail/Angel LLC, an Oregon limited liability company ("Grantee").

Grantor is the owner of that certain real property legally described on Exhibit A, attached hereto (the "Grantor Property"). Grantee is the owner of that certain real property legally described on Exhibit B, attached hereto (the "Grantee Property"). The Grantor Property and Grantee Property are referred to herein individually as a "Property."

A storm water sewer line (the "Line") currently runs from the Grantor Property to the Grantee Property, discharging on the Grantor Property, all as further set forth on Exhibit C, attached hereto (the "Map"). However, the Grantee Property is not tied into the Line. Grantee desires to tie into the Line and discharge storm water from the Grantee Property into the Line and ultimately onto the Grantor Property. Grantor desires to grant to Grantee an easement permitting Grantee to tie into the Line and discharge storm water from the Grantee Property into the Line and ultimately onto the Grantor Property.

NOW, THEREFORE, Grantor and Grantee agree as follows:

1. Sewer Easement. Grantor hereby grants to Grantee an easement permitting Grantee to tie into the Line and discharge storm water from the Grantee Property into the Line and ultimately onto the Grantor Property, as shown on the Map, together with a non-exclusive easement for ingress and egress over and across such portions of the Grantor Property as may be reasonably required for access to and maintenance of the Line up to the point of Grantor's connection to the Line (the "Easement Area"). In the exercise of its right under this Easement, Grantee shall use its reasonable efforts to avoid causing any damage to, or interference with, any improvements on the Grantor Property or the Easement Area. After the performance of any work in the Easement Area, Grantee shall, replace and restore, at Grantee's sole cost and expense, such area and/or improvements (including, without limitation, any fences, landscaping or drainage systems or other improvements) disturbed by such work to the condition of such area and/or improvements prior to the performance of such work.

2. Maintenance. Grantor and Grantee shall each be responsible for the maintenance and repair of the portions of the Line located on their respective Property until such two separate sewer lines form one "party line". Once such two separate lines form one

"party line", all maintenance and repair costs for the "party line" portion of such sewer line shall be equally shared by Grantor and Grantee.

3. Liens. Grantee shall not permit any claim, lien or other encumbrances arising from Grantee's use of the Line to accrue against or attach to the Grantor Property.

4. Grantee Indemnity. Grantee shall hold harmless, defend and indemnify Grantor from and against all claims, demands, actions or suits, including reasonable attorneys' fees and costs, brought against Grantor arising out of or relating to the use by Grantee (including its agents, employees, contractors, subcontractors, invitees or suppliers) of the Line, except to the extent that such claims arise due to the negligence or willful misconduct of Grantor.

5. Grantor Indemnity. Grantor shall hold harmless, defend and indemnify Grantee from and against all claims, demands, actions or suits, including reasonable attorneys' fees and costs, brought against Grantee arising out of or relating to the use by Grantor (including its agents, employees, contractors, subcontractors, invitees or suppliers) of the Line, except to the extent that such claims arise due to the negligence or willful misconduct of Grantee.

6. Rights of Successors. The easements, restrictions, benefits and obligations hereunder shall create mutual benefits and servitudes running with the land and shall bind and inure to the benefit of the Grantor and Grantee, and their respective heirs, representatives, lessees, successors and assigns.

7. No Public Dedication. The easements, rights and privileges provided for in this Easement shall be for the private use of the persons and entities herein described. Such easements, rights and privileges are not intended to create, nor shall they be construed as creating, any rights in or for the benefit of the general public.

8. Modification and Cancellation. This Easement (including exhibits) may be modified or canceled only by written agreement signed by Grantor and Grantee or their successors in interest.

9. Headings. The headings herein are inserted only as a matter of convenience and for reference and in no way define, limit or describe the scope or intent of this Easement nor in any way affect the terms and provisions hereof.

10. Attorneys' Fees. In the event a suit, action, arbitration, or other proceeding of any nature whatsoever, including, without limitation, any proceeding under the US Bankruptcy Code, is instituted, or the services of an attorney are retained, to interpret or enforce any provision of this Easement or with respect to any dispute relating to this Easement, the prevailing party shall be entitled to recover from the losing party its reasonable attorneys', paralegals', accountants', and other experts' fees and all other fees, costs, and expenses actually incurred and reasonably necessary in connection therewith. In the event of suit, action, arbitration, or other proceeding, the amount thereof shall be determined by the judge or arbitrator, shall include fees and expenses incurred on any appeal or review, and shall be in addition to all other amounts provided by law.

11. Entire Agreement/Severability. This Easement constitutes the entire agreement, and this Easement once executed and delivered shall not be modified or altered in any respect except by a writing executed and delivered in the same manner as required

by this document. Invalidation of any provision of this Easement, in whole or in part, or of any application of a provision of this Easement, by judgment or court order shall in no way affect other provisions or applications.

[Signatures on following page.]

IN WITNESS WHEREOF, this Declaration has been executed as of the day and year first written above.

GRANTOR:

Wilsonville/Angel LLC,
an Oregon limited liability company

By: _____

Title: _____

GRANTEE:

Wilsonville Retail/Angel LLC,
an Oregon limited liability company

By: _____

Title: _____

EXHIBIT A
Grantor Property Legal Description

EXHIBIT B
Grantee Property Legal Depiction

EXHIBIT C
Map