

J

STREETSCAPE PLAN

ADOPTED
19 OCTOBER 2021
ORDINANCE NO. 850



WILSONVILLE TOWN CENTER STREETSCAPE PLAN



acknowledgments

A special “thank you” to community members and all who participated in this planning process. We appreciate your time and ideas.

CITY COUNCIL

Mayor Julie Fitzgerald

Kristin Akervall, Council President

Charlotte Lehan, Councilor

Ben West, Councilor

Joann Linville, Councilor

Tim Knapp, Mayor Emeritus

PLANNING COMMISSION

Kamran Mesbah, Chair

Jennifer Willard, Vice Chair

Ronald Heberlein, Commissioner

Jerry Greenfield, Commissioner

Olive Gallagher, Commissioner

Breanne Tusinski, Commissioner

Aaron Woods, Commissioner

Phyllis Millan, Former Commissioner

CITY OF WILSONVILLE PROJECT TEAM

Miranda Bateschell

Kim Rybold

Philip Bradford

Zach Weigel

Delora Kerber

Georgia McAllister

Eric Loomis

Dustin Schull

Preston Langeliers

CONSULTANT TEAM

SERA Architecture and Design

table of contents

Acknowledgements	2
How to use this Plan	4
1. Project Background, Vision, and Context	5
2. Town Center Opportunities	11
3. Design Elements	15
4. Streetscape Designs	30
IN.3: Park Place Redesign	31
IN.4: Park Place Extension	34
IN.6: Courtside Drive Extension	39
IN.7: Park Place / Wilsonville Road Extension	42
IN.8: Town Center Loop West	44
IN.9: Local Street	47
IN.12: Promenade	50
Private Open Space Design	53
Appendices	54

how to use this plan

The Town Center Streetscape Plan is a regulatory document that intends to provide design guidance for private development and public projects that construct the public realm improvements in line with the vision of the Town Center Plan.

- Chapter 3 of the Town Center Streetscape Plan contains the street furnishings and materials that are required on the various street types and cross sections contained within the document.
- Chapter 4 depicts the materials, products, and streetscape furnishings in different locations throughout Town Center in the form of illustrations that are intended to provide additional guidance on how the future streetscapes may look in the future.
- The appendices provide additional information to the user of the plan by including specification sheets for the recommended products identified in Chapter 3.

Design Element description

Product, design, and construction description

SIDEWALK DESIGN

DESIGN ELEMENTS

Sidewalks are the heart of any active street. They are where travel to destinations occurs, but also where people may unexpectedly gather to talk, grab a coffee, or window shop. Sidewalks will be wide, well-protected, shaded by a robust tree canopy, and accommodating of changing uses throughout the year. On Signature streets, a concrete stamping pattern marks the space, highlights the busiest places in the Town Center, and aids in navigation. The Signature sidewalk pattern is one of several design features used to identify the Town Center's most vital people streets and promenades, which warrant City investment to construct.

STANDARD



Sidewalks will be located throughout the Town Center per Transportation System Plan designations. Sidewalk through area will be at least 5 feet in all locations and is often significantly wider (see location details). Sidewalks will have a light broom finish and will conform with other Public Works Standards in 201.2.25, Detail No. RD-1075 Concrete Sidewalk, and RD-1076 Sidewalk Next to Swale.

This treatment will be used commonly on Standard Streets and in the walkway areas of Enhanced Streets (which will also use the paver inlay in the furnishing zone used at right).

ENHANCED



A furnishing stripe of Permeable Concrete Interlocking Pavers will be used on Enhanced streets to highlight the area for plantings, benches, bike racks, and vehicle egress from on-street parking. The stripe helps visually separate the sidewalk through zone from parking and street.

A new construction detail will be required to describe product and installation method. The Western Interlock *La Pietra Moderna* Cambridge Blend is recommended.

SIGNATURE



A custom concrete stamping pattern, potentially with several varying color treatments, is to be used in corner intersection areas along Signature Streets and wrapping the corner onto intersecting streets. The Signature pattern can be used for the full sidewalk length, or limited to just corner locations for cost savings.

A new construction detail will be required as part of the process to finalize the sidewalk design.

CITY OF WILSONVILLE TOWN CENTER STREETSCAPE PLAN 17

Prototype design page

Description of streetscape features and use of products and plantings

LOCATION IN.6: COURTSIDE DRIVE EXT.

(Park Place East to Town Center Loop West) (Framework Project)

STREET DESIGN PROTOTYPES



6. CURB EXTENSIONS

Along the Courtside Drive extension

Enhanced seating

Planting bed and stormwater areas

7. SIDEWALK DESIGN

Enhanced sidewalk consisting of Standard concrete pattern with Enhanced furnishing zone paver inlay

8. CROSSWALKS

Standard "continental stripe" crosswalks

9. LANDSCAPE

Trees in tree grates at 30 foot spacing along the street

Plantings in curb extensions

10. BIKE FACILITIES

Shared travel in regular vehicle lanes

"Shared lane" markings

41

01 *project background, vision, and context*

“Town Center is a vibrant, walkable destination that inspires people to come together and socialize, shop, live, and work”.

- *Wilsonville Town Center Plan (2019)*

PLAN PURPOSE

The Town Center Streetscape Plan functions as a further guide to implementing the street designs conceived in the Wilsonville Town Center Plan. The vision for Town Center calls for a vibrant, walkable community hub that will offer an increasing array of opportunities to live, work, play, shop, and gather. One of the Town Center Plan’s goals is for Harmonious Design, seeking to link the entire district through coherent and attractive design, especially of streets, plazas, and gathering spaces.

The Streetscape Plan provides more detail about sizes, locations, and materials for vehicle lanes, parking, sidewalks, landscape and tree planting, seating, crosswalks, and other features of the public realm.

This Plan integrates guidance from other recent or currently-underway plans including the Citywide Signage and Wayfinding Plan, the Urban Forest Management Plan, and the I-5 pedestrian bridge and gateway plaza design.

Finally, the Design Elements and Street Location Prototype chapters of the Streetscape Plan describes actions and responsibilities of the City and private landowners developing property in implementing various street location projects.



“Town Center is the heart of Wilsonville. It is home to active parks, civic spaces, and amenities that provide year-round, compelling experiences. Wilsonville residents and visitors come to the Town Center for shopping, dining, culture, and entertainment.

- Wilsonville Town Center Plan (2019)

THE STARTING POINT: WILSONVILLE TOWN CENTER PLAN

The Streetscape Plan is one piece of many ongoing efforts to implement and refine the community’s vision documented in the Town Center Plan. The Town Center Plan comprehensively plans for changing land uses, public investment, open space, streets, and infrastructure.

Town Center, which has been in development and undergoing constant change since the early 1970s, is a largely vehicle-oriented, low-density commercial district (with some residential), covered as much by parking lots as any other use. The Town Center Plan (2019) envisions a walkable, vibrant district bolstered by welcoming public spaces and a healthy mix of uses supporting people's needs.

Integral to achieving the community's principles and vision for the Town Center, is ensuring buildings and streets are pedestrian-oriented with a cohesive and attractive design. The Streetscape Plan is intended to identify the specific design elements that will enable the City to achieve the expectations/vision for the public realm.



Concept illustrations from the Town Center Plan describe how the streetscape and public environment support development and placemaking.

THE STARTING POINT: WILSONVILLE TOWN CENTER PLAN

The six Town Center Plan goals below all support the vision for an active, diverse destination serving people throughout the day.

GOAL 1



Environmental Stewardship
Integrate nature into the design and function of infrastructure and development in Town Center to protect Wilsonville’s natural resources.

GOAL 2



Harmonious Design
Ensure buildings and streets are pedestrian-oriented and there are a variety of quality building types and land uses.

GOAL 3



Mixed-Uses
Encourage development that provides interconnected land uses that incorporate play and recreation, with a range of retail, services, dining and entertainment options, and increased opportunities for residential and employment uses.

GOAL 4



Safe Access and Connectivity
Provide transportation infrastructure designed to create a safe, accessible environment for all modes of travel in Town Center, foster multimodal access between buildings and land uses in Town Center, connect to surrounding neighborhoods, and provide local and regional accessibility.

GOAL 5



Community Gathering Places
Provide vibrant, diverse and inclusive places that bring people together with activities and events for year-round fun, culture and socializing.

GOAL 6



Economic Prosperity
Create opportunities to support and grow existing business and attract new businesses that provide a diverse range of local and regional retail, entertainment, and commercial activities.

PLAN PROCESS

The Streetscape Plan project began in September 2020 and concluded in October 2021. Three preliminary concepts - River Environment, Agricultural Legacy, and Technological Innovation (further described on the following page and in the Appendix) - inspired by Wilsonville’s history and ecology, and aligned with the Town Center Vision, were presented at a community forum and Planning Commission in November 2020.

The team used that late 2020 input to refine the diagrammatic concepts into more recognizable streetscape designs with preliminary product selections. This design was presented at another forum in February 2021, online survey, and Planning Commission in March 2021. The preferred design blended aspects of the River Environment and Technological Innovation concepts, which City Council reviewed in April 2021 and confirmed the overall direction of the plan.

Planning Commission and City Council reviewed the location-specific prototypes in June 2021, and directed the team to complete location-specific designs; finalize the product, materials, and plant palette; and prepare the final Plan. Planning Commission reviewed and City Council adopted the Plan in October 2021.

Fall 2020

Existing Conditions	Background Plan Review
Preliminary Concept Designs	
Public Forum #1	Planning Commission and City Council Review

Winter-Spring 2021

Refined Preliminary Concepts	
Public Forum #2 and Online Survey	Planning Commission and City Council Review
Recommended Design Selection, Location-Specific Design, and Draft Plan Preparation	
Planning Commission Review #3 and City Council Review	

Summer-Fall 2021

Additional Location-Specific Design, Design Elements Refinement, and Final Plan Preparation	
Planning Commission Review #4 and City Council Adoption Hearings	

STREETSCAPE DESIGN SELECTION PROCESS

The Streetscape Plan provides design guidance and product details for the range of street locations and types anticipated through the Town Center Plan, which identifies approximate alignments and overall street configurations. To consider alternatives for the overall design theme, palette, and aesthetic of the streets, the Streetscape Plan team prepared three preliminary concepts to explore the arrangement and aesthetic of streetscape elements.

Each concept intended to reflect a central piece of Wilsonville’s economic and natural history. Results from the second community forum and Planning Commission review were favorable towards the orderly and linear style of the sidewalk surfaces in the Technological Innovation concept blended with the sinuous shapes of the combined planter beds and seating areas in the River Environment concept.

The recommended concept uses a bold, geometric sidewalk pattern to define different spaces and provide rhythm to the design, and punctuates it with curving, soft-edged seating and planters at corners and key mid-block locations to provide visual contrast and create spaces for plant ecology and people gathering along the street.

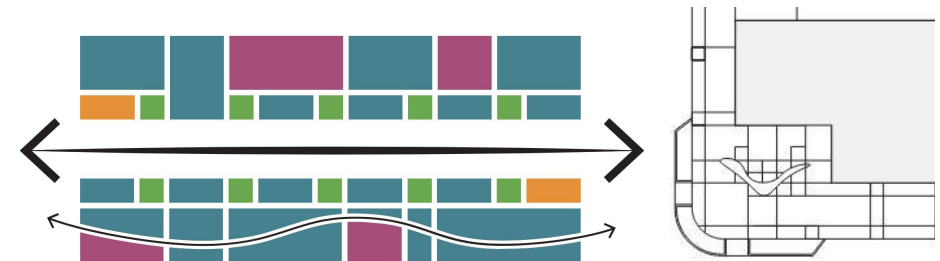

Concept 1. Agricultural Legacy: rectilinear arrangement of walking, landscape, and gathering areas; rustic stone, wood, and metal elements

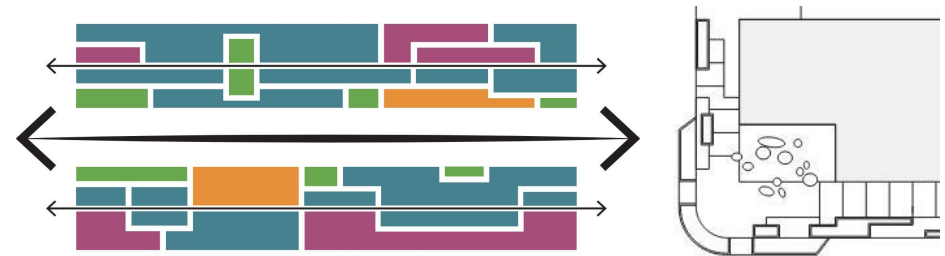

Concept 2. Technological Innovation: linear pattern forms help organize spaces for walking, plantings, and gathering; clean, smooth, simple materials



Concept 3. River Environment: curvilinear arrangement of spaces, use of “river eddies” to define gathering and landscape area; landscaped areas punctuate the sidewalk along the curb and building faces

02 town center opportunities

A street network that supports people living, working, and playing on a daily basis. Design features that feel at home in the Town Center yet derive influence from the entire city and the Willamette Valley region.

OPPORTUNITIES TO IMPLEMENT THE TOWN CENTER'S URBAN FRAMEWORK

The Town Center Plan establishes the overall relationship of streets to land uses, open spaces, and other connectivity routes (see diagram at right). Streets through the Main Street district and elsewhere in Town Center comprise several Framework projects, which are vital routes to be constructed in initial phases and with public leadership and funding support ensuring their early implementation as catalyst projects.

The Town Center Plan was initiated several years ago in recognition that the Town Center is in need of a major update to become a revitalized mixed-use district. The Town Center Streetscape Plan provides further street design details for specific locations and to unify overall street and public space aesthetics in Town Center.

An inventory of prototype design locations, and a photo catalog of current conditions, are on the following pages to further describe the features and places recommended for improvement in the Streetscape Plan.

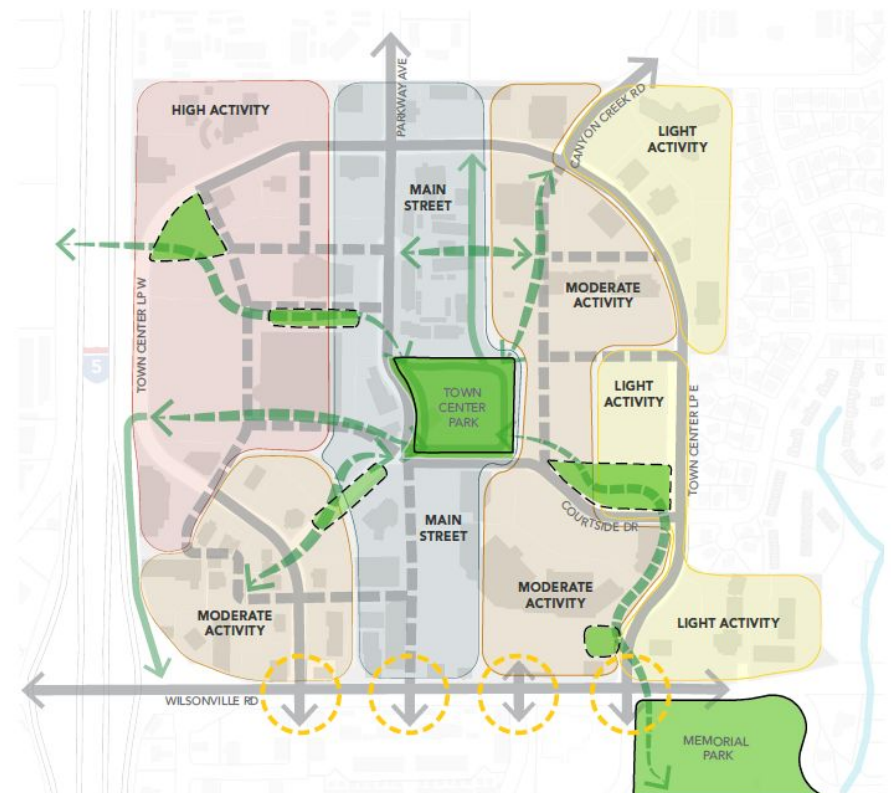

This diagram, which is Figure 2 Design Concept, in the Town Center Plan, depicts the relationship of character areas, such as Main Street, to streets and key routes such as the Emerald Chain.



LOCATION IN.2
Opportunity for Parkway Ave cul-de-sac reconfiguration and street improvements



LOCATION IN.3
Opportunity for Park Place "Main Street" shared-street improvements



LOCATION IN.4
Planned new "Framework" street to extend Park Ave to Wilsonville Road

	NEW STREET		NEW INTERSECTION
	EXISTING STREET IMPROVEMENT		INTERSECTION IMPROVEMENTS
	NEW PEDESTRIAN/BICYCLE ROUTE		OPEN SPACE /PARK
	PEDESTRIAN/BICYCLE IMPROVEMENTS		EMERALD CHAIN
	MAIN STREET DISTRICT (MSD)		
	COMMERCIAL - MIXED-USE (C-MU)		
	MIXED-USE (MU)		
	NEIGHBORHOOD - MIXED-USE (N-MU)		

TOWN CENTER OPPORTUNITIES

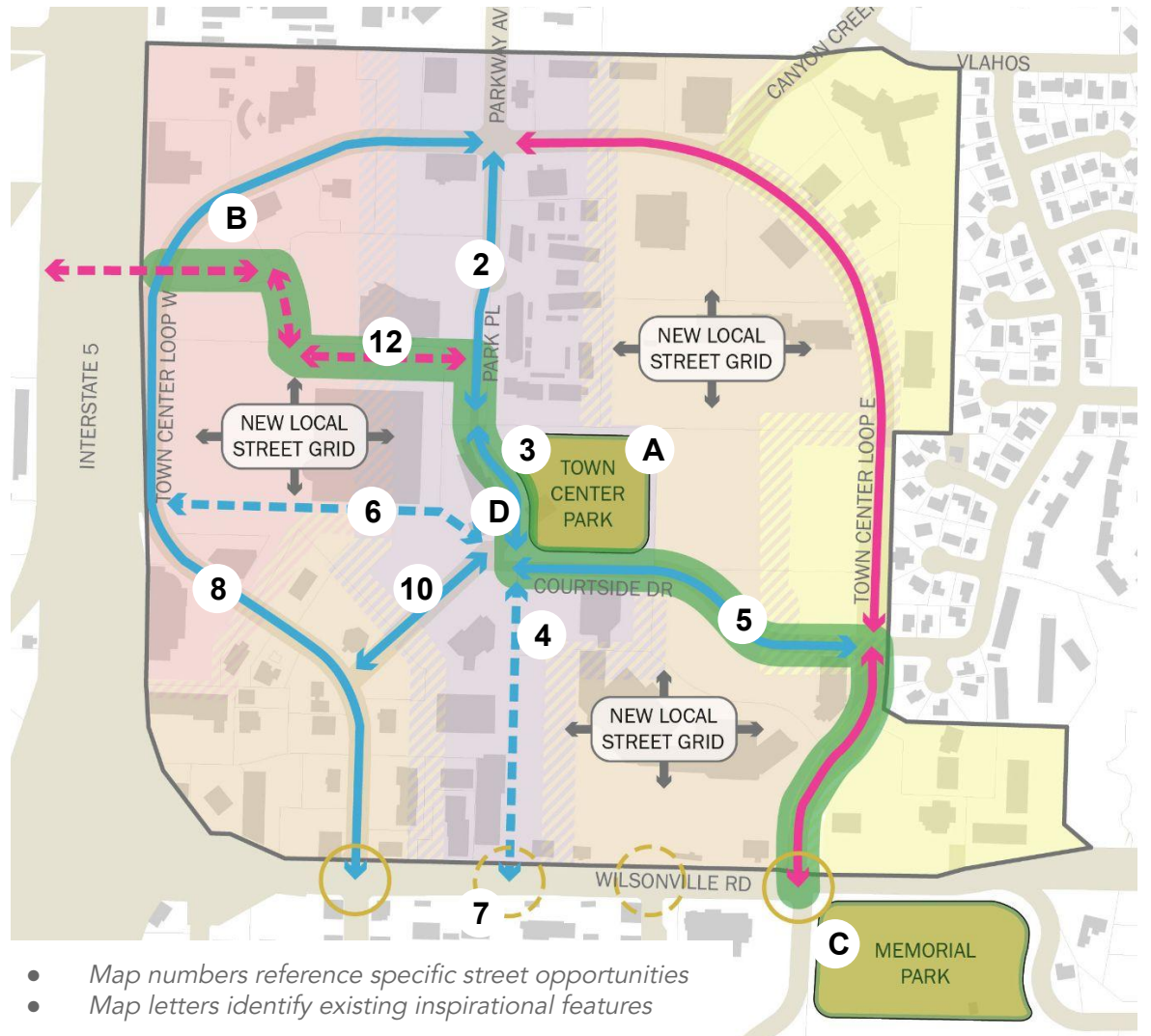

TOWN CENTER OPPORTUNITIES



*LOCATION IN.5
Opportunity for Courtside Drive
multimodal and transit improvements*



*LOCATION IN.8
Opportunity to calm traffic and add
sidewalks and bikeways on TC Loop W.*



*LOCATION IN.6
Planned Courtside Drive extension from
Park Ave to Town Center Loop West*



*LOCATION IN.10
Opportunity to improve Park Place as a
no-vehicle walking and biking park route*

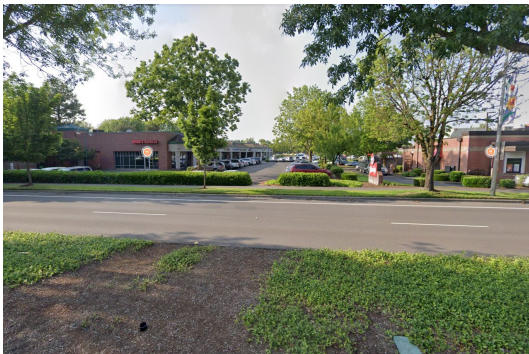

*LOCATION IN.7
Planned new intersection of future Park
Place "Main Street" and Wilsonville Road*



*LOCATION IN.12
Planned new "Promenade" street
connecting to I-5 Bridge and Cycle Track*

The images on the preceding page and this page show key streets identified in the Town Center Plan for significant improvement. While Town Center's streets today are generally functional for moving vehicles and accessing parking, they have obviously been built over many phases and lack coherence in the ways they provide (or often don't) sidewalks, on-street parking, landscaping, lighting, seating areas, and other amenities.

Streets and access drives lack hierarchy and don't match the future vision for Town Center mobility or more mixed-use and urban land uses.

Existing streets in Town Center do not contain multimodal transit options or support the future urban land uses planned for in the Town Center Plan. These streets also do not contribute to a strong sense of place. The streetscape Plan identifies opportunities to better serve people’s needs in the future, through improvements in key areas such as: a harmonious and unified design, options to provide changing amenities and support different uses as the Town Center develops over time.

The Streetscape Plan recommends features, materials, and other details that create three different street types that will complement existing and future development in Town Center.

This assessment builds upon the Town Center Plan to help identify which streets (both existing and future) should receive investment at various levels. Chapter 3 describes the varying investment levels recommended for different specific street design prototypes.



INSPIRATION A
Use of stone, brick, metal, and other natural features - Korean War Memorial



INSPIRATION B
Stormwater facilities on sites and streets with stone and abundant plantings



INSPIRATION C
Murase Plaza: stone structures, CorTen steel, paver blocks, seating areas

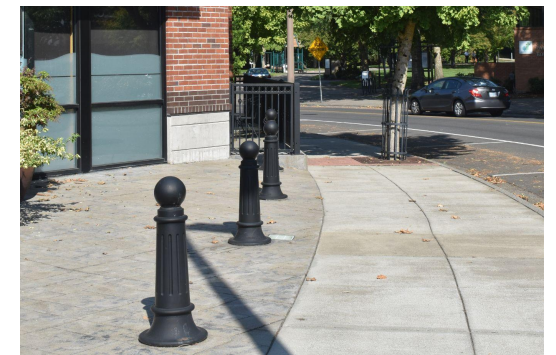

INSPIRATION D
A newer business development in the Town Center, with more abundant street trees, wider sidewalks, and a connected entryway plaza

03 *design elements*

A small number of humble but elegant pieces can create an inspired place

FURNISHINGS, MATERIALS, AND FLORA COMPOSE A STREETScape

This chapter describes the products, materials, plantings, and other components that comprise a complete streetscape. Each design element was carefully considered for the impact it would have on the aesthetics and functionality of the street, as well as practical concerns such as cost and maintenance. Whether constructed by the City as a Framework project or private developers along with their site improvements, these furnishings and other materials will shape a design that unifies the Town Center, aids wayfinding, and supports travel options.

The design elements reflect three investment tiers (described on the following page), while maintaining the flexibility and compatibility to function throughout the Town Center's various streets and promenades, and for use in plazas and courtyards built through private development. Product details are described when possible, along with links to manufacturer specifications. This is a long-term implementation plan and may require updates by the City in the future as the phasing of street projects change and recommended products may be unavailable.

In certain instances such as the Signature concrete stamp / color pattern a general aesthetic is described and will be further detailed in later steps by the City through the creation of construction detail drawings for various streetscape elements called for by this plan. In other cases, such as light poles, benches, and primary street trees – specific products and plantings are recommended. The City should create a standard detail that balances a unique, signature design with the practicalities of repeating a pattern throughout the Town Center during many different phases of project construction.

DEGREES OF INVESTMENT AND CHANGE

Different streets around the Town Center will be constructed with varying degrees of investment and design detail. These determinations were made based on the Town Center Plan framework for streets, relationship of streets to adjacent development patterns, and identification of streets as high activity and visibility locations or lower activity locations.



STANDARD DESIGN

Standard furnishing elements, sidewalk, and crosswalk design - mostly compliant with existing Public Works standards and details

Trees / lighting along entire blocks

Curb extensions in certain locations to serve pedestrian safety and provide on-site stormwater facilities



ENHANCED DESIGN

Mostly Standard sidewalk and crosswalk designs, with Enhanced (and some Signature) elements in selected locations to bolster placemaking, mobility, and safety improvements

Trees / lighting along entire blocks

Curb extensions more widely used where feasible for pedestrian safety and stormwater services



SIGNATURE DESIGN

Signature elements and sidewalks used extensively throughout the streetscape

Trees / lighting along entire blocks

Curb extensions used wherever possible to provide pedestrian amenity space, and landscape - custom integrated benches and planters define many gathering spaces

APPLYING THE INVESTMENT LEVELS

The three investment levels are applied differently across streets within Town Center to best suit the future development patterns and activity levels envisioned by the Land Use Sub-districts within the Town Center Plan. In order to focus investment on the most heavily trafficked portions of Town Center, the higher investment levels are planned primarily on Main Streets, Collector Streets, and framework projects such as the promenade. Other streets will contain the same high quality street furnishings, but allow for a more cost effective design and construction for a large portion of Town Center.

STANDARD DESIGN

The standard investment level is typically applied along Local Street cross sections that are outside the Main Street District. This investment level will be the most commonly utilized of the three investment levels within Town Center.

ENHANCED

The enhanced investment level is applied across the existing Courtside Drive and future extension. A significant portion of Courtside Drive is within the Main Street District and Commercial Mixed Use districts, which will have higher pedestrian traffic thus warranting a higher level of design.

SIGNATURE

Park Place and the future Park Place Extension to Wilsonville Road will be the Main Street for Town Center. The Park Place right of way is fully within the Main Street Sub-district and warrants the highest level of investment. Other Signature investment areas include framework projects such as the Promenade.

Note: Where higher investment levels intersect with lower investment levels, the higher investment level shall be carried across the intersection and take precedence over the lower tier to provide clear transitions between investment levels. As development occurs, elements from higher investment levels may be utilized elsewhere in lower tiers where appropriate, as approved by staff.

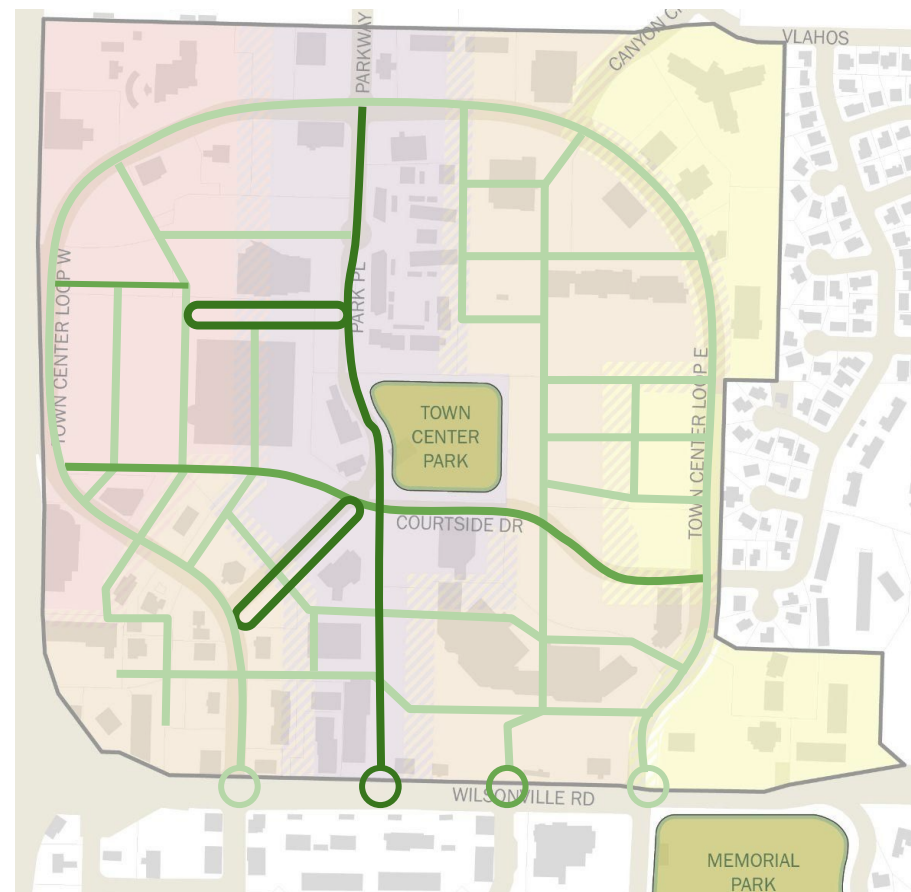

SIDEWALK DESIGN

Sidewalks are the heart of any active street. They are where travel to destinations occurs, but also where people may unexpectedly gather to talk, grab a coffee, or window shop. Sidewalks will be wide, well-protected, shaded by a robust tree canopy, and accommodating of changing uses throughout the year. On Signature streets, a concrete stamping pattern marks the space, highlights the busiest places in the Town Center, and aids in navigation. The Signature sidewalk pattern is one of several design features used to identify the Town Center's most vital people streets and promenades, which warrant City investment to construct.

STANDARD



Sidewalks will be located throughout the Town Center per Transportation System Plan designations. Sidewalk through area will be at least 5 feet in all locations and is often significantly wider (see location details). Sidewalks will have a light broom finish and will conform with other Public Works Standards in 201.2.25, City Detail No. RD-1075 Concrete Sidewalk, and City Detail No. RD-1076 Sidewalk Next to Swale.

This treatment will be used on Standard streets and in the walkway areas of Enhanced Streets.

ENHANCED



A furnishing stripe of Permeable Concrete Interlocking Pavers will be used on Enhanced streets to highlight the area for plantings, benches, bike racks, and vehicle egress from on-street parking. The stripe helps visually separate the sidewalk through zone from parking and street.

A new construction detail will be required to describe product and installation method. The [Western Interlock La Pietra Moderna Cambridge Blend](#) is recommended.

SIGNATURE



A custom concrete stamping pattern, potentially with several varying color treatments, is to be used in corner intersection areas along Signature Streets and wrapping the corner onto intersecting streets. The Signature pattern can be used for the full sidewalk length, or limited to just corner locations for cost savings.

A new construction detail will be required as part of the process to finalize the sidewalk design.

CROSSWALK DESIGN

Crosswalks are a complement to sidewalks in allowing safe passage and easy connections across streets, and thus throughout the entire Town Center and beyond. Crosswalks are subject to numerous roadway marking requirements established at the City and Federal level. Conventional Continental patterns are suitable for most Standard and Enhanced locations, while a custom high-visibility concrete banded stamp pattern will greatly improve pedestrian visibility at crossings in high investment streetscape areas.

STANDARD/ENHANCED



Standard crosswalks shall use a Staggered Continental pattern (also known as “zebra stripe”) in accordance with Pavement Marking Detail No. RD-1280.

Examples of this crosswalk treatment abound in Wilsonville, including in the Town Center, along Wilsonville Road, in Old Town, and in Villebois.

SIGNATURE



The Signature crosswalk uses a custom concrete stamping and color treatment to highlight high-volume crosswalks in key Town Center locations.

A new construction detail will be required as part of the process to finalize the crosswalk design. City Detail No. RD-1110 for Curb Extensions is a starting point which will need amendment or addition to reflect new curb ramp orientation, surface materials, tactile pad specifications, planters, wing depth, and travel lane width for Signature design locations.

City Detail No. RD-1145 describes mid-block crossing construction with associated crossing marking, planter locations, curb ramp placement, and signage. This detail may need an amendment to include a mid-block crossing with curb-extension treatments reflective of the Signature design.

BENCHES AND SEATING

Streets are not simply spaces for movement, they are also places to linger, gather, and do business. Seating in a variety of forms provides places to rest and socialize with others. Benches and seating can also be attractive pieces of the streetscape, using natural and quality materials, and taking on dynamic, artful forms. Several seating options are described below for use varyingly across the Standard, Enhanced, and Signature configurations.

STANDARD



The [Landscape Forms Generation 50](#) traditional back bench in Onyx low-sheen powdercoat and thermally-modified Ash wood with angled end and centers arms.

This bench will be used in furnishing zones on sidewalks on Standard streets in Town Center. It may be used in private plazas and open spaces elsewhere throughout Town Center as well.

It is an attractive, wood-based, off-the-shelf product offering simple installation and low maintenance requirements.

ENHANCED



The [StreetLife Rough&Ready Curved Bench](#) product with [slat back accessory](#) using FSC hardwood and a CorTen base.

The City of Wilsonville can work with the manufacturer and development partners to specify an exact product length and curve radius to accommodate three people and to fit in conventional furnishing zones on Enhanced sidewalks.

SIGNATURE



The [StreetLife Rough&Ready Free Form Tree Isles](#) using FSC hardwood and CorTen base is readily installed in custom forms and sizes tailored to provide seating as part of planter installations in along Signature streets.

The seating uses a metal structure and cladding that integrates into a raised planter. The FSC hardwood model with CorTen base is recommended and will need to be coordinated with the raised planter design. A new construction detail will be required as part of the process to finalize the Signature bench design.

PRIMARY STREET TREES

Street trees help fulfill numerous Town Center goals, particularly for environmental stewardship, harmonious design, and community gathering spaces. Street trees provide shade and enclosure to sidewalks, habitat for birds and other animals, and will unify the appearance of the Town Center as trees mature and become prominent, seasonally changing, features. Where possible, and aligned with Urban Forest Management Plan recommendations, existing healthy trees should be retained in the streetscape and adjacent areas.

PRIMARY STREET TREE



In a larger area such as Town Center, it is important to have a variety of trees to provide a diverse tree canopy. The following tree species are intended to be the primary tree species utilized in Town Center:

- *Acer rubum* 'Armstrong' Armstrong Maple
- *Quercus robur* 'Fastigata' Skyrocket Oak
- *Ginkgo Biloba* 'Autumn Gold' Autumn Gold Ginkgo
- *Platanus x acerfolia* Bloodgood London Planetree
- *Liriodendron tulipifera* 'Fastigata' Columnar Tulip Tree

The primary street trees shall be placed along the entire sidewalk in minimum 4 foot by 4 foot tree wells. Tree spacing along the street can vary due to individual site conditions, but trees shall typically be spaced every 30-40 feet, with space for lighting, benches, and other elements between. Once a primary tree species is selected for a street, it shall be planted along the entire length of the street with the same tree on both sides of the street. City Detail No. RD-1235 specifies tree wells and grates. City Detail No. RD-1240 specifies tree clearance and spacing.

Substitution of the primary and other tree types may be considered by the City in alignment with the recommendations of the Urban Forest Management Plan.

ACCENT STREET TREES AND STORMWATER PLANTS

ACCENT TREES



Accent trees will be used primarily in Enhanced and Signature street locations to bring variety and uniqueness to plantings in curb, extensions, high activity corners, mid-block crossings and plazas. These species add variety through different shapes and foliage colors. The following species will serve as accent trees in Town Center:

- *Frangula purshiana* Cascara
- *Cercis occidentalis* Western Redbud
- *Cornus 'Eddies White Wonder'* Eddies White Wonder Dogwood
- *Quercus garryana* Oregon White Oak
- *Magnolia grandiflora* Southern Magnolia
- *Pinus ponderosa willamettensis* Willamette Valley Ponderosa Pine
- *Pistacia chinensis* Chinese Pistache

While accent trees may also be substituted based on recommended tree types in the Urban Forest Management Plan, selection of these trees should prioritize trees with unique characteristics that provide contrast with the primary street tree utilized on the street.

STORMWATER PLANTS



Stormwater facilities will be part of the streetscape where needed and spacing allows for inclusion of the facility. In Signature locations, storm water facilities will be integrated with seating areas. See Section 3 Appendix A of the City's Stormwater & Surface Water Design & Construction Standards for construction and planting information.

STREET LIGHTING

Street lighting plays a key role in defining a district and creating a welcoming environment for travel, gathering, holding festivals, and doing business. Lighting also supports safety by increasing visibility for pedestrians. The lighting products below are in line with the overall aesthetic of the streetscape designs and product selections. These products are [PGE Option C](#) products and are to be owned and maintained by the City.

STANDARD AND ENHANCED



Standard and Enhanced streets will use PGE Option C equipment including:

- Fixture: Landscape Forms Rama Area Light Luminaire & Mounting Bracket in Dusk.
- Pole: Landscape Forms Rama Area Light (RAF21) 19.7 foot height in Dusk.
- Mounting: Single Mount Bracket (RAA01)

Spacing shall be determined at time of development using photometric plans. Lighting poles shall be placed near the curb in the furnishing zone with the fixture facing the roadway. Lighting shall be installed per regulations in the City of Wilsonville Public Works Standards 201.9.01 and City Detail RD-1300.

SIGNATURE



Signature streets will use the same PGE Option C Landscape Forms Rama Product in Dusk (see "Product Data" link [here](#)), but will be differentiated with the 19.7 foot height staggered design (RAF31) similar to the image above.

NOTE: At the time of adoption, the City of Wilsonville does not have the capacity to store and maintain a supply of replacement poles for the Landscape Forms Rama Product. In the future, the City may have the capability and will require the Landscape Forms Rama product within Town Center. If not, the product shall default to the most contemporary option on the PGE Option A list.

STREET LIGHTING

The products below are compliant with the PGE street lights on the [Option A/B](#) product list. The PGE product lists are more traditional in design, which does not suit the modern environment of Town Center. As the PGE list is subject to change, the intent is to use the most contemporary Option A product at the time of development. Based on current products, the options below are compliant with Option A and are the most suitable option to blend with other design choices.

INTERNAL STREETS



Standard, Enhanced, and Signature streets will use a PGE Option A/B approved and owned equipment list including:

- Fixture: [Aurora King K829](#) - using a flat lens, black finish, other specifications from the [PGE product list](#).
- Pole: [Hadco P2065-16-A](#) aluminum pole with 16' mounting height product and anchor base in black color.
- Mast arm: The Aurora King KPL20 is the specified mast arm for PGE compliant configurations.
- Signature streets will utilize the same equipment, with the addition of a second fixture mounted over the sidewalk

Lighting shall be installed per regulations in City of Wilsonville Public Works Standards 201.9.01 and City Detail No. RD-1300.

TOWN CENTER LOOP



The product specified for Town Center Loop is the [Leotek Green Cobra](#) series with the aluminum pole as specified on City Detail RD-1300. This product is currently installed along both sides of Town Center Loop. When redevelopment occurs adjacent to Town Center Loop, this product shall be reinstalled per the PGE Option A requirements.

NOTE: The City of Wilsonville will continue to monitor the PGE list for updates, and potentially more contemporary products, that could be replaced as the City's specification in the future.

STREET DESIGN ELEMENTS

A variety of streetscape furnishings and surfaces will be used throughout the Town Center in order to provide the necessary urban living infrastructure. These furnishings can be used in the Standard, Enhanced and Signature locations. to bolster the sense of place, gathering locations, wayfinding, and design unity of the street. The descriptions below and the location-specific designs in the following chapter describe more siting and installation guidance.

BIKE RACKS



The [Landscape Forms Loop](#) in low-sheen Onyx finish bicycle parking racks will be installed as part of the public streetscape design and associated with private development to fulfill bicycle parking requirements.

These bicycle racks are suitable in the planting/furnishing (on the sidewalk near the curb) and frontage (on the sidewalk near private property) zones of the streetscape. This specific product is not suitable for in-street Bike Corral parking in locations that might otherwise be vehicle parking. The [Dero Arc rack in Iron Gray installed using the Cycle Stall](#) configuration is suitable for in-street bike corrals.

BOLLARDS

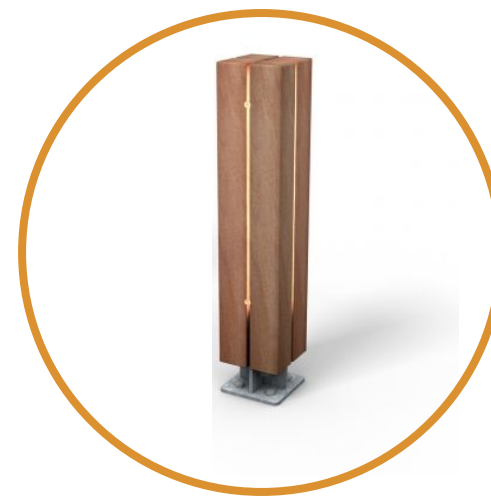

The [Streetlife Solid Quatro](#) bollard may be used selectively to limit or prevent vehicle traffic. This will be applicable at the Promenade location in particular, and other locations around the Town Center such as Park Place and adjacent plazas of private property (some of which are identified in the Location-specific designs). City Detail No. RD-1195 will need to be updated to specify the installation of this bolt-mounted bollard and to additionally accommodate removable bollard installation in some locations.

Bollards will use an FSC Hardwood and CorTen steel base; options include both with and without LED illumination.

STREET DESIGN ELEMENTS

TRASH CONTAINER



[Landscape Forms Generation 50](#) waste container. Low sheen Onyx color finish with Ash wood accents.

Waste containers shall be installed in the furnishing zone of the sidewalk or in suitably spacious curb extension areas, especially near seating areas. Waste containers should be installed on all Signature streets where practical, and can be used on Standard and Enhanced streets where desired. This waste container may also be used in private plazas.

DRINKING FOUNTAIN



[Most Dependable 10140 SMFA](#) drinking fountain. Black finish with attached pet fountain. Install with 10" stainless steel mount.

Drinking fountains shall be installed in the furnishing zone of the sidewalk or in suitably spacious curb extension areas, especially near seating areas. Drinking fountains should be installed on all Signature streets where practical, and can be used on Standard and Enhanced streets where desired. This drinking fountain may also be used in private plazas. The City may additionally consider using this product as replacement and new installations in Town Center Park.

STREET DESIGN ELEMENTS

PUBLIC ART



The Streetscape Plan does not specify exact art products nor locations for their installation. The street design seeks to provide abundant spaces in furnishing zones, curb extensions, planter beds, and adjoining plazas for a variety of free-standing sculptural, light-based, surface-mounted, and temporary art installations.

SIGNAGE AND WAYFINDING

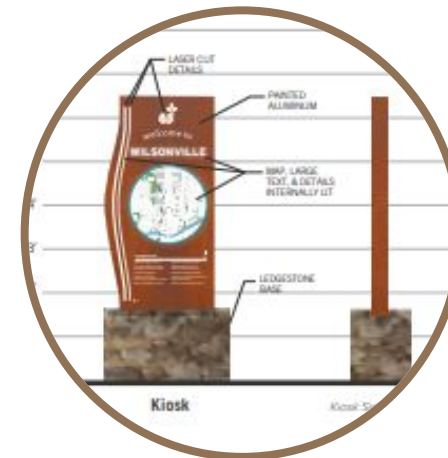

The Town Center's streets and public areas will incorporate wayfinding signage in locations recommended in the *Wilsonville Signage and Wayfinding Plan* (details of which are in Appendix D). One such installation will be a wayfinding kiosk at the corner of Wilsonville Road and the new Park Place extension.

STREET DESIGN ELEMENTS

POWDERCOATED IRON TREE GRATES

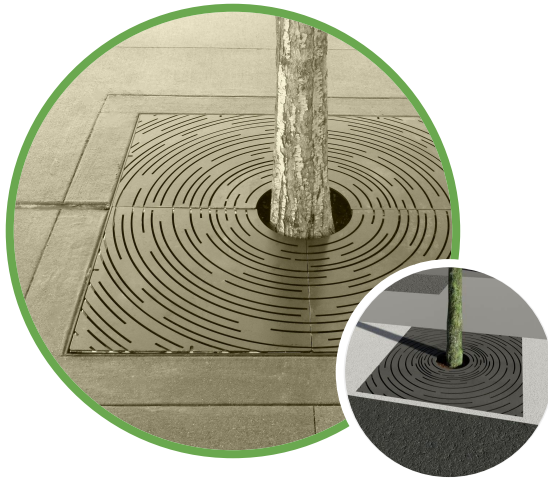

The [Iron Age Designs Spin](#) model tree grate will add a subtle sense of movement and whimsy to tree plantings in the Signature street locations.

A 4-foot by 4-foot tree grate is recommended in most locations. Other trees may be integrated as part of a larger planter bed or stormwater facility, in which case a tree grate is not used.

The City's current specification for an Urban Accessories tree grate, in City Detail No. 1235 is to be used for Standard and Enhanced locations when tree grates are desirable.

NATURAL STONE



Decorative rocks can be placed in landscape area, stormwater basins, and selectively as seating in certain street and plaza gathering areas. Stone is most suitable for use in Signature streets with a higher investment level and where physical space exists for their installation. This Plan doesn't specify an exact product, but recommends locally-sources basalt or granite for durability, color selection, and prevention of freeze/thaw cracking.

ADA TACTILE PAD



The [Neenah Foundry Quick Connect](#) cast iron tactile pad adds a functional and attractive detectable surface to Signature street location curb ramps at crosswalks.

In Standard and Enhanced locations, the [ADA Solutions Cast-in-Place Tactile Panel](#) in black color shall be used.

STREET DESIGN ELEMENTS

TRANSIT STOP



SMART Transit uses an [Oregon Corrections Enterprises bus shelter](#) at select stop locations around the network. SMART and the City of Wilsonville are considering other transit shelter products specific to Town Center. Placement of the shelters should provide easy access to bus doors while not interfering with sidewalk or bikeway travel, parked vehicle door swing zones, or entrances to buildings, places, and parks.

No additional products are specified in the Streetscape Plan, but colors and material selection should be consistent with those used elsewhere in Town Center. The Courtside Drive Extension prototype includes a placeholder footprint for a future transit marker or shelter.

BIKEWAY DESIGN



Most bikeway routes are already identified and facility types provided in the Town Center Plan and subsequent Transportation System Plan 2020 Update. Bikeway varieties include shared-street markings, buffered bikeways, protected cycletracks, and car-free promenade routes.

Buffered bikeways are one recommended facility type in Town Center. The NACTO [Urban Bikeway Design Guide](#) is instructive for routing and marking buffered bikeways. City Detail No. RD-1290 provides specific standards for buffered bikeway lane markings.

TACTICAL URBANISM



“Tactical Urbanism” techniques are an approach to quickly installing low-cost street elements, often on a trial basis to study their effectiveness and consider longer-term or regular seasonal use. Examples include street markings to create sidewalks or bikeways, or street seats installed near the curb to expand outdoor seating options (often linked to a nearby restaurant, which has been a common use in 2020 and 2021 in response to the Covid pandemic). The [Tactical Urbanism Guide](#) is a good starting place for ideas and assembly examples.

04 Streetscape Designs

This Plan applies the design elements of the previous chapter in specific locations around Town Center, varying how they are packaged based on whether the location is designated for Standard, Enhanced, or Signature investment. These location specific street designs guide implementation of the streets in Town Center and will serve as prototypes to determine the appropriate design for other street segments in Town Center within the same investment level. This map provides a key to these locations selected from the Town Center Plan's infrastructure project list for illustrating expected street design at build out, which are further described in the following pages.

Location IN.3 - Park Place Redesign (Framework)
(Park - Courtside Drive) **Signature Design**

Location IN.4 - Park Place Extension (Framework)
(Courtside Drive - Wilsonville Road) **Signature Design**

Location IN.6 - Courtside Drive Extension (Framework)
(Park Place East - Town Center Loop West)
Enhanced Design

Location IN.7 - Intersection of Wilsonville Road and
Park Place **Signature Design**

Location IN.8 - Town Center Loop West
Standard Design

Location IN.9 - Local Street **Standard Design**

Location IN.12 - Promenade (Framework Project)
Signature Design

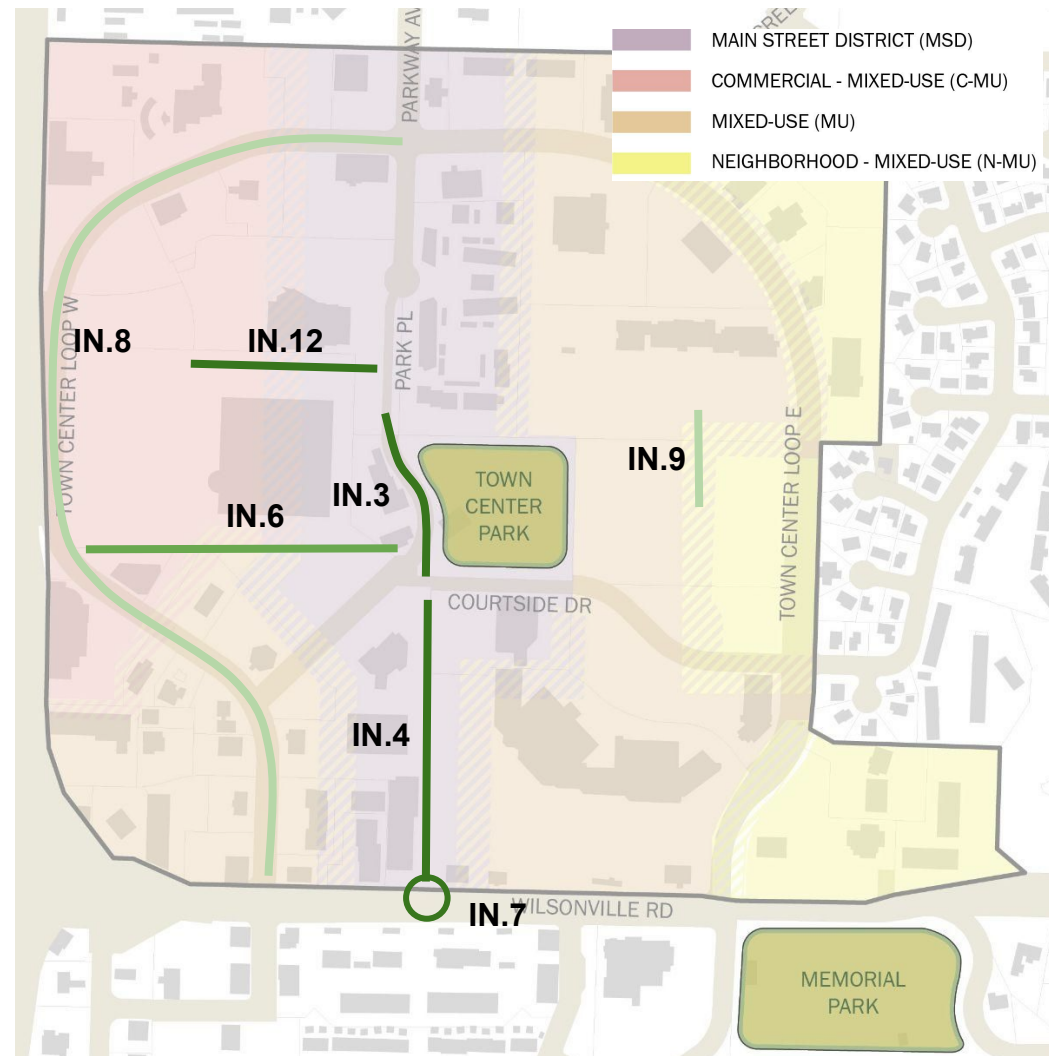

LOCATION IN.3: PARK PLACE REDESIGN

(Along west side of Town Center Park) (Framework Project)

ENHANCING THE TOWN CENTER “MAIN STREET”

Park Place will be rebuilt as a Signature *main street* serving many of the Town Center’s busiest future businesses, mixed-use housing, and open spaces. The “Festival” Street design provides wide sidewalks, a buffered two-way bike facility, and on-street parking, and is intended to significantly calm traffic passing through with its curbsless design and abundant streetscape features. Seating, custom landscape and stormwater facilities, and a variety of plantings and trees help make Park Place a welcome gathering space and event location.

TOWN CENTER PLAN FUNDAMENTALS

- Framework (high priority) Project
- Walkable, modern main street district with wide sidewalks
- Two vehicle travel lanes, buffered two-way bike lanes
- Street parking / stormwater areas
- Road straightened at south end to connect to new Park Place Extension street

IMPLEMENTATION BASICS

- Define specific project boundaries, especially on the Town Center Park side where Park design may also change.
- Seek to construct as a single-phase project lead by the City.
- Coordinate the design of intersections at Courtside Drive and the Promenade, which use different investment levels or different vehicle operation patterns.
- Limit the number of driveways extending from Park Place.



INVESTMENT LEVEL
SIGNATURE
ENHANCED
STANDARD

LOCATION IN.3: PARK PLACE REDESIGN

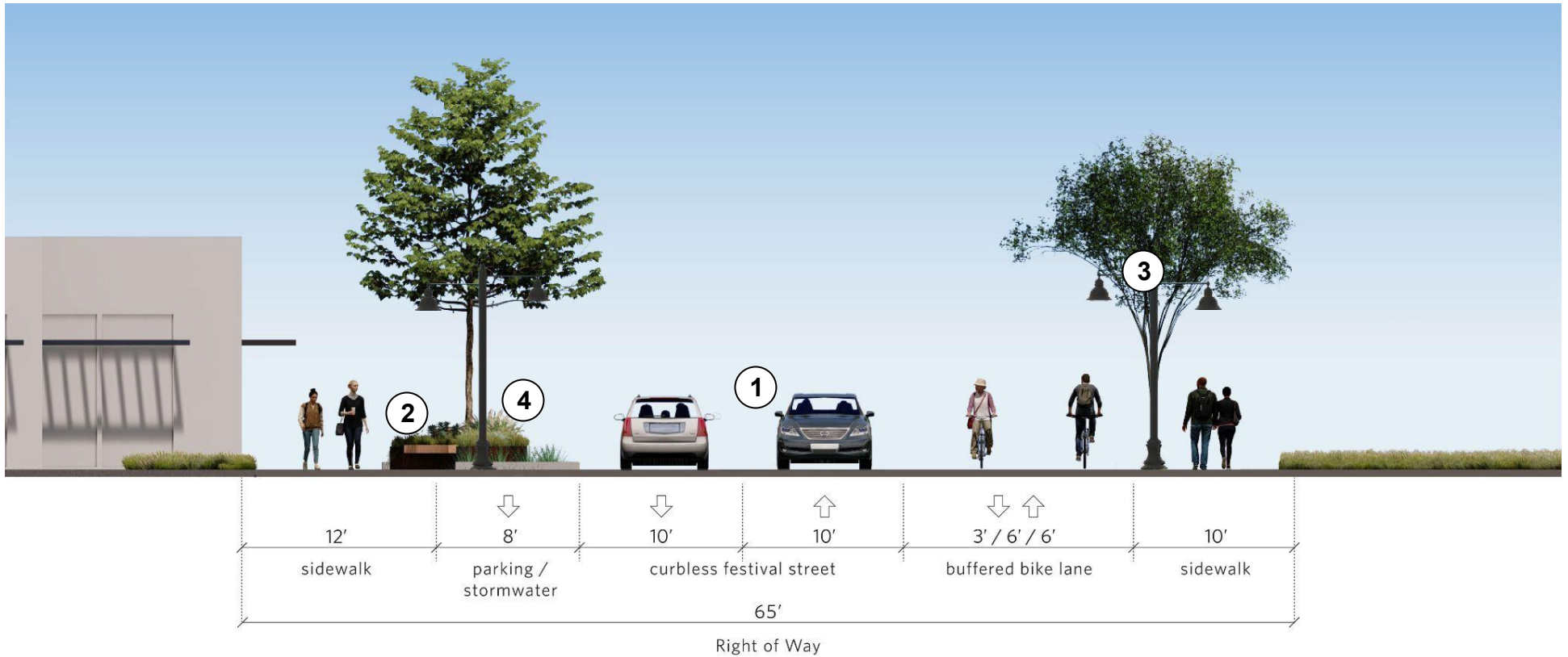

1. STREET ZONE

"Festival" curbless street - closable for events
Buffered bike lane two-way as part of Emerald Chain

2. SEATING

Signature custom seating at locations throughout
Standard and Enhanced bench options for use

3. LIGHTING

Double-headed lighting spaced at 60 foot intervals along both sides of the entire street

4. STORMWATER

Stormwater catchment in curb extensions and midblock locations where feasible

5. TRANSIT

No transit service or stations planned in this location

LOCATION IN.3: PARK PLACE REDESIGN

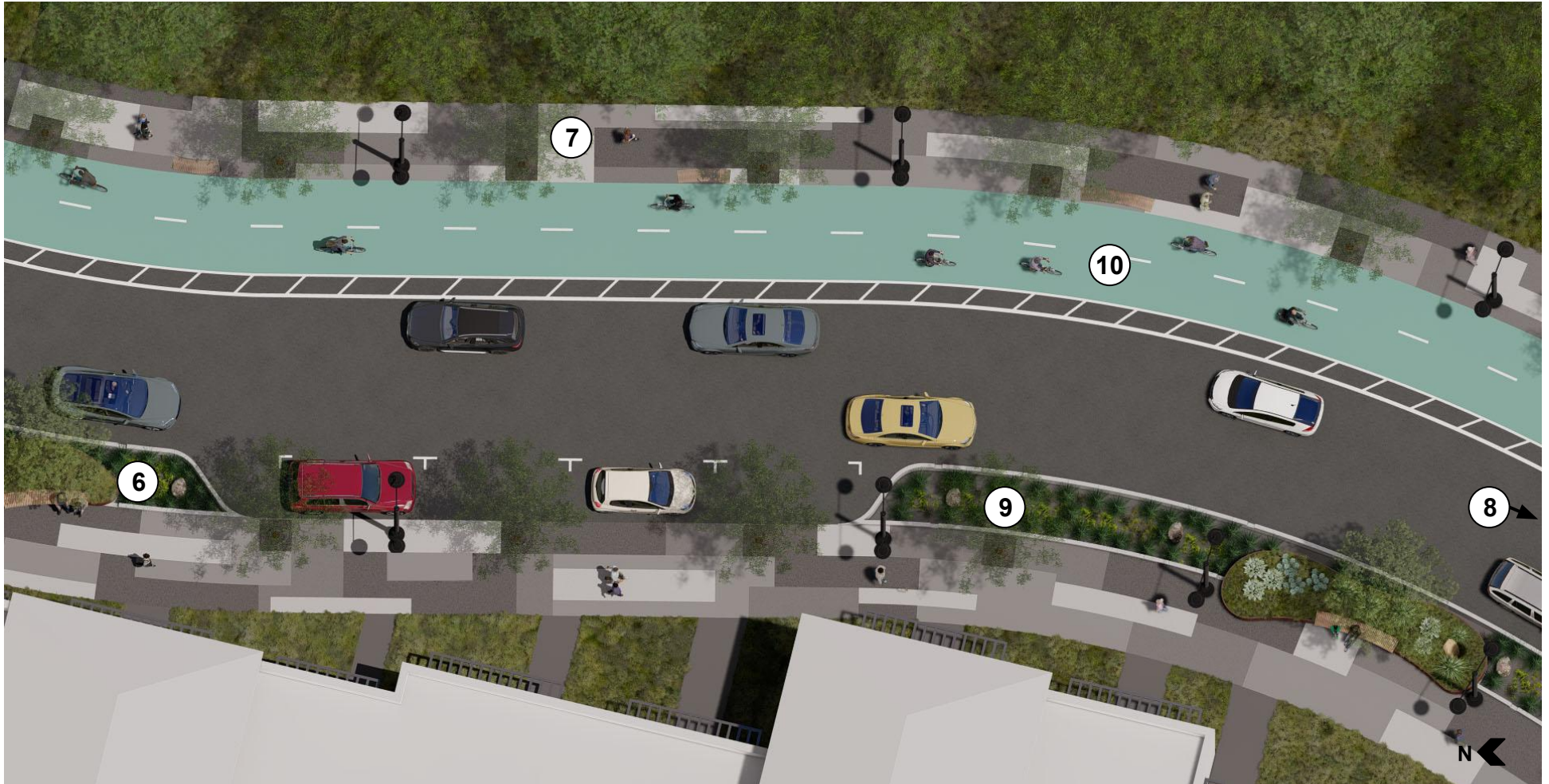

6. CURB EXTENSIONS

At intersections and some midblock locations (not on 2-way bikeway side)

Integrated seating

Planting bed and stormwater areas

7. SIDEWALK DESIGN

Signature pattern-formed concrete throughout

8. CROSSWALKS

Signature pattern-formed concrete at intersections

CorTen pads

9. LANDSCAPE

Trees in tree grates at 30 foot spacing along the street

Plantings and stormwater in curb extensions

10. BIKEWAY

Buffered two-way bike lanes along Town Center Park (east) side of street

LOCATION IN.4: PARK PLACE EXTENSION

(Courtside Drive to Wilsonville Road) (Framework Project)

EXTENDING THE TOWN CENTER “MAIN STREET”

An extension of Park Place through existing parking lots helps complete the walkable, retail-oriented main street through the entire Town Center. Wide sidewalks, shared lanes supporting bicycle travel, and on-street parking support people visiting businesses by many different modes. Abundant landscaping with street trees, planting boxes, and stormwater catchment areas improves the functionality and aesthetic appeal of the street.

TOWN CENTER PLAN FUNDAMENTALS

- Framework (high priority) Project
- Walkable, modern main street district with wide sidewalks
- Two travel lanes, shared with bikes
- Street parking / stormwater areas
- Creates new signalized intersection at Wilsonville Road

IMPLEMENTATION BASICS

- Conduct additional design work to more precisely place the new street alignment, which replaces existing parking.
- Fund construction primarily from public sources (with private support and coordination) as a single-phase project.
- Build stub-outs as needed in anticipation of future intersection street connections.
- Limit driveway access from Park Place Extension - emphasize driveway access off intersecting Local Streets.

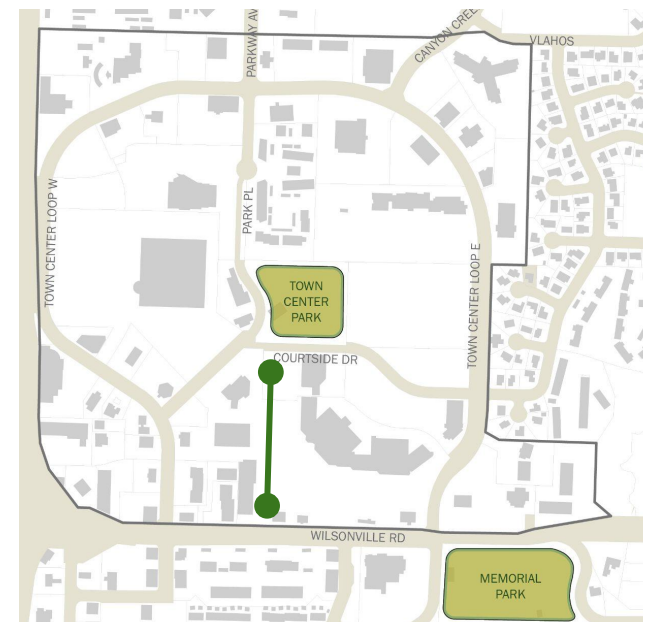

INVESTMENT LEVEL
SIGNATURE
ENHANCED
STANDARD

LOCATION IN.4: PARK PLACE EXTENSION

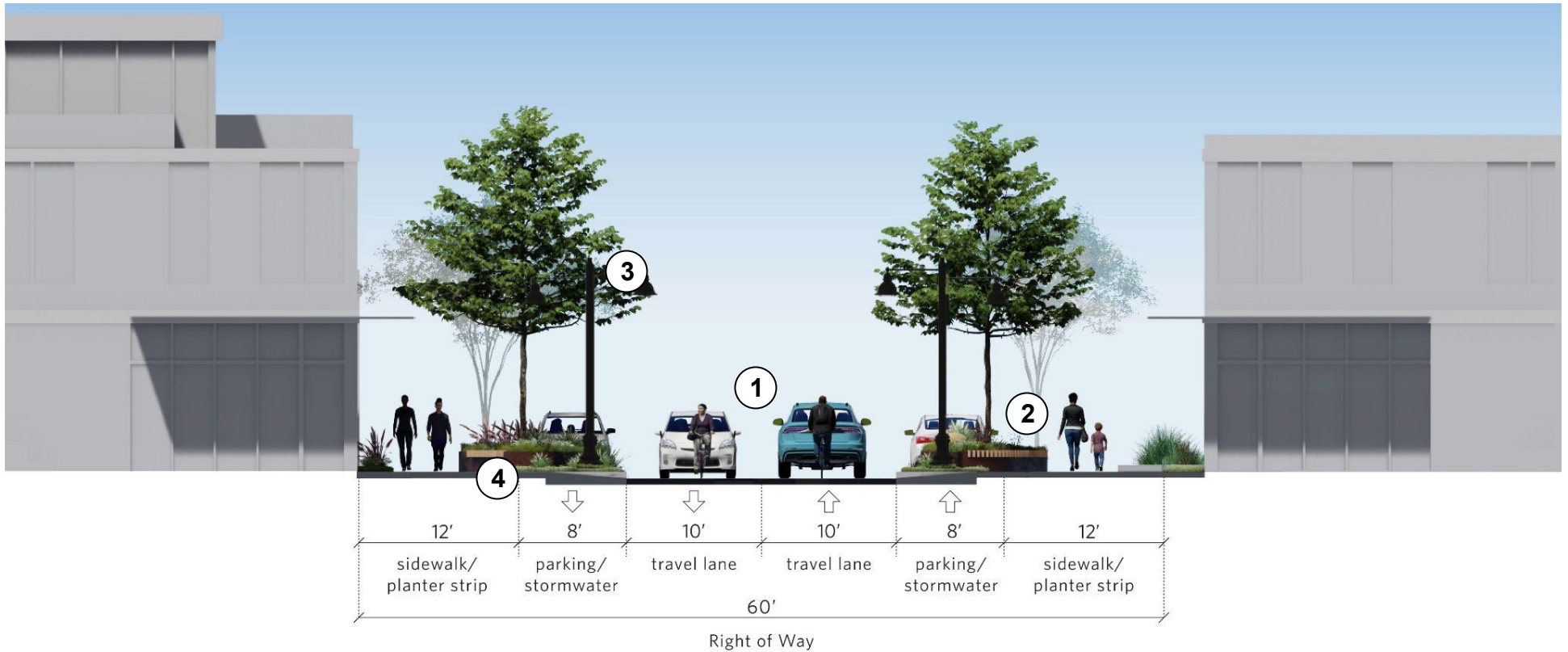

1. STREET ZONE

Bikes and vehicles share street

On-street parking and parklet options

2. SEATING

Signature custom seating at corners

Enhanced bench in midblock locations

3. LIGHTING

Double-headed lighting spaced at 60 foot intervals along both sides of the entire street

4. STORMWATER

Stormwater catchment in curb extensions and midblock locations

5. TRANSIT

No transit service or stations planned in this location

LOCATION IN.4: PARK PLACE EXTENSION



6. CURB EXTENSIONS

Along the Park Place Extension

Integrated seating

Planting bed and stormwater areas

7. SIDEWALK DESIGN

Signature pattern-formed concrete throughout

8. CROSSWALKS

Signature pattern-formed concrete at intersections and midblock locations

CorTen pads

9. LANDSCAPE

Trees in tree grates at 30 foot spacing along the street

Plantings and stormwater in curb extensions

10. BIKE FACILITIES

Shared travel in regular vehicle lanes

"Shared lane" markings

LOCATION IN.4: PARK PLACE EXTENSION



This perspective rendering shows how the Signature design Park Place extension applies to the street and interfaces with adjacent sites, buildings, and intersections with other streets (a Local Street) in this instance. Curb extensions (1) creates safer crossings and provide space for the Signature sidewalk design (2) to wrap the corner. Corners also support the custom integrated seating and planting feature (3) and a variety of trees are planted along the entire block (4). Park Place becomes a slow vehicle street that supports shared lanes for bicycle travel (5).

LOCATION IN.4: PARK PLACE EXTENSION



This concept illustration depicts the streetscape with the potential Rama light fixture. As discussed in the Street Light Design Element section, the City of Wilsonville seeks to substitute this, or similar, light product in the future if PGE compliance and the City's storage and maintenance capacity allows.

LOCATION IN.6: COURTSIDE DRIVE EXT.

(Park Place East to Town Center Loop West) (Framework Project)

NEW CONNECTIONS IN THE CORE OF TOWN CENTER

Courtside Drive will extend from Park Place at the modified intersection on the southwest corner of Town Center Park, to the west, and make a new intersection with Town Center Loop West. This will help improve access and create places for people on public streets through a district that is currently a parking lot, but is envisioned as a mixed-use residential and commercial area.

TOWN CENTER PLAN FUNDAMENTALS

- A two-way street with shared lanes for vehicles and bicycles, and on-street parking.
- Streetscape elements including benches and the Enhanced paving pattern in the furnishing zone.

IMPLEMENTATION BASICS

- Coordinate and synchronize design and construction with potential future redevelopment of Fry's to the north.
- Prepare to modify the on-street parking design and location to fit bus service and station pullout locations.

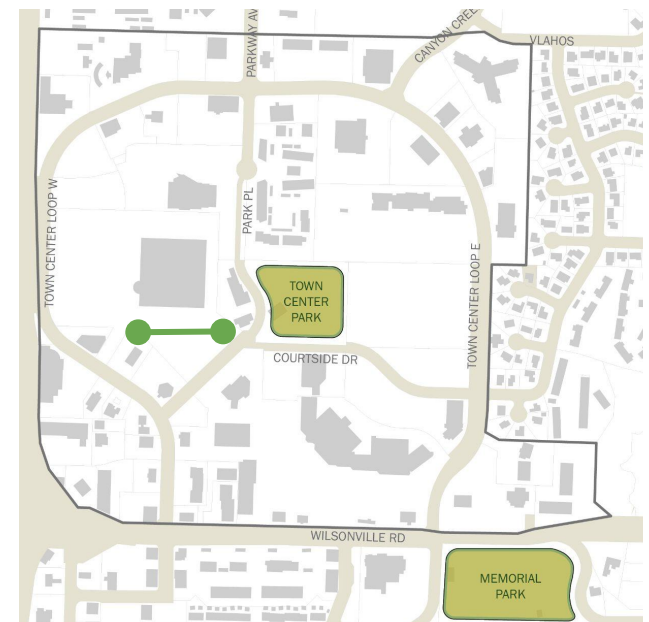

INVESTMENT LEVEL
SIGNATURE
ENHANCED
STANDARD

LOCATION IN.6: COURTSIDE DRIVE EXT.

(Park Place to Town Center Loop West) (Framework Project)

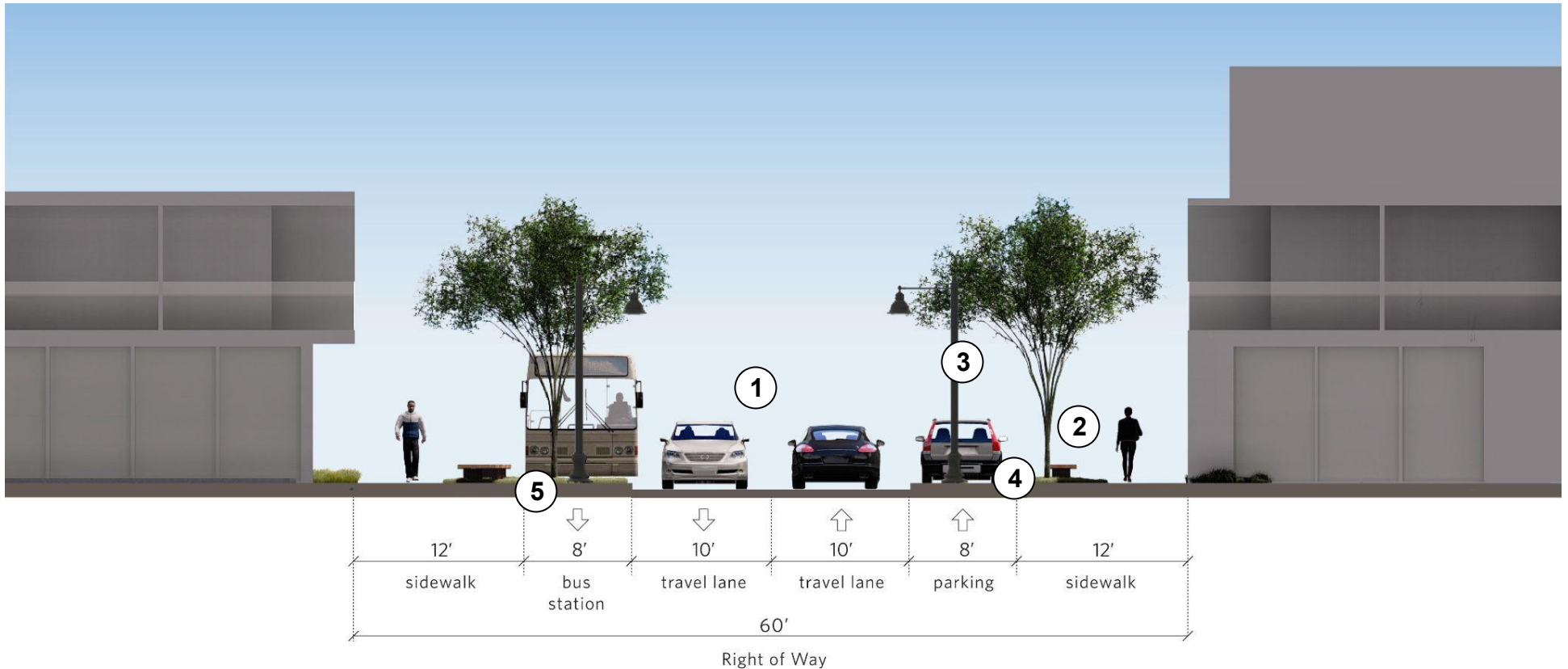

1. STREET ZONE

Bikes and vehicles share street

On-street parking and parklet options

2. SEATING

Enhanced bench in curb extension areas and midblock in the furnishing zone

3. LIGHTING

Single-headed lighting spaced at 60 foot intervals along both sides of the entire street

4. STORMWATER

Stormwater catchment in curb extensions and midblock locations

5. TRANSIT

SMART service and station stops planned
A 4'x8' shelter pad to serve the bus pull-out in the parking zone is identified in the plan

LOCATION IN.6: COURTSIDE DRIVE EXT.

(Park Place East to Town Center Loop West) (Framework Project)

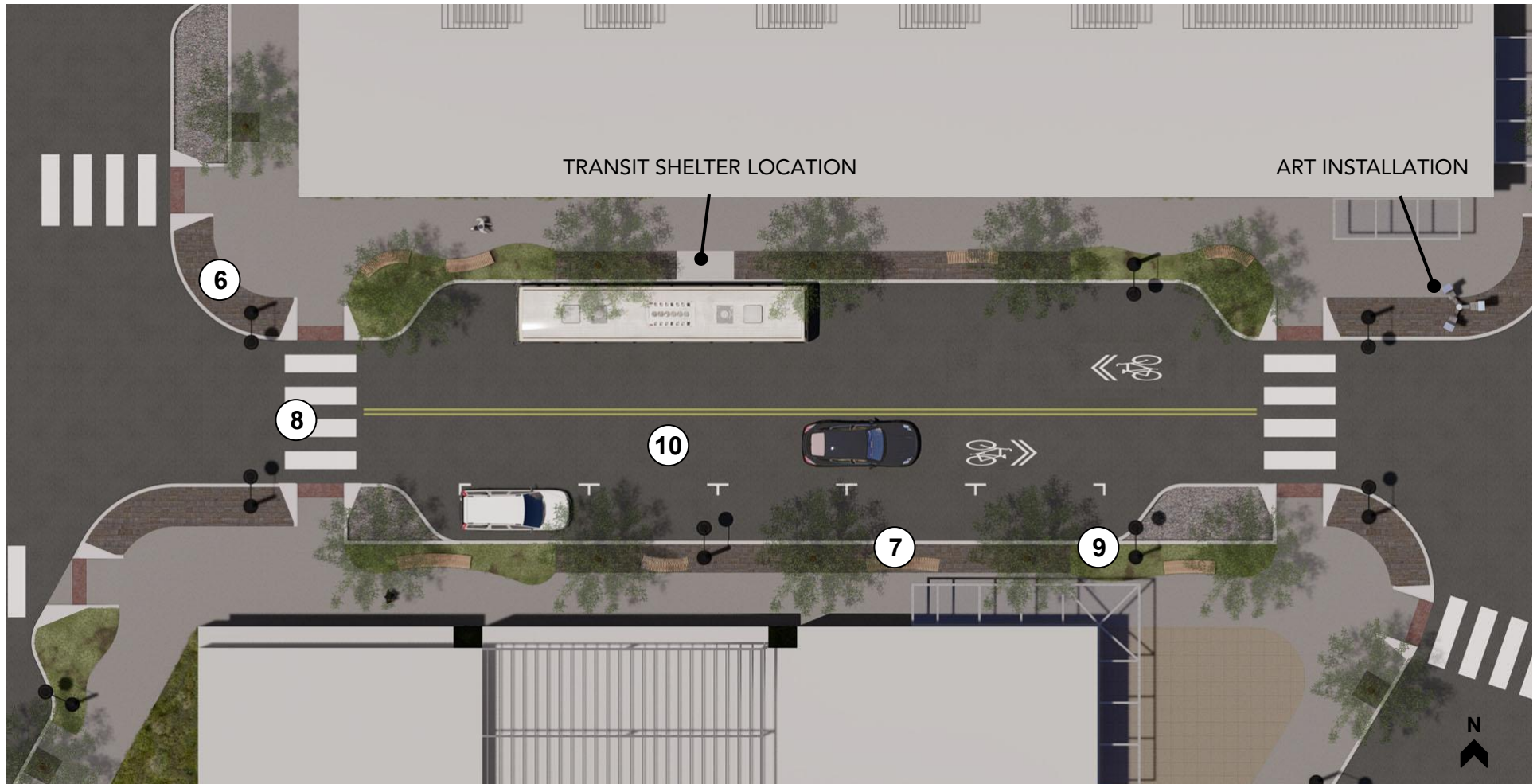

6. CURB EXTENSIONS

Along the Courtside Drive extension

Enhanced seating

Planting bed and stormwater areas

7. SIDEWALK DESIGN

Enhanced sidewalk consisting of Standard concrete pattern with Enhanced furnishing zone paver inlay

8. CROSSWALKS

Standard "continental stripe" crosswalks

9. LANDSCAPE

Trees in tree grates at 30 foot spacing along the street

Plantings in curb extensions

10. BIKE FACILITIES

Shared travel in regular vehicle lanes

"Shared lane" markings

LOCATION IN.7: PARK PL / WILSONVILLE RD

(New intersection design)

A NEW CONNECTION TO TOWN CENTER'S "MAIN STREET"

An upgraded intersection at Wilsonville Road where the new Park Place extension connects is one of several major improvements to Wilsonville Road to serve the Town Center. This will be a new four-way intersection, the northern segment of which is within the scope of the Town Center Streetscape Plan. The street design shows how the Park Place Signature street will tie into improvements along Wilsonville Road and the intersection.

TOWN CENTER PLAN FUNDAMENTALS

- Makes Park Place a key new gateway point to the Town Center and includes locations for artwork and wayfinding signage near the intersection that will encourage people to venture into the main street
- Intersection allows turn movements in all directions

IMPLEMENTATION BASICS

- Coordinate design between the full Park Place extension and the overall Wilsonville Road project - this intersection ties together a Signature Town Center street with conventional design on Wilsonville Road.
- Clearly identify the limits of the improvement geometry to ensure the Signature design makes a distinct presence on the corner but does not interfere with basic improvements and new traffic patterns at the intersection.

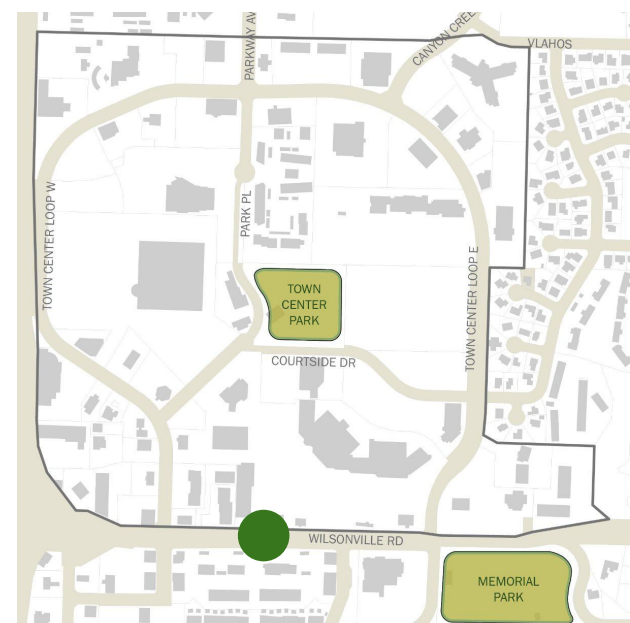

INVESTMENT LEVEL
SIGNATURE
ENHANCED
STANDARD

LOCATION IN.7: PARK PL / WILSONVILLE RD

STREETSCAPE
DESIGNS

(New intersection design)

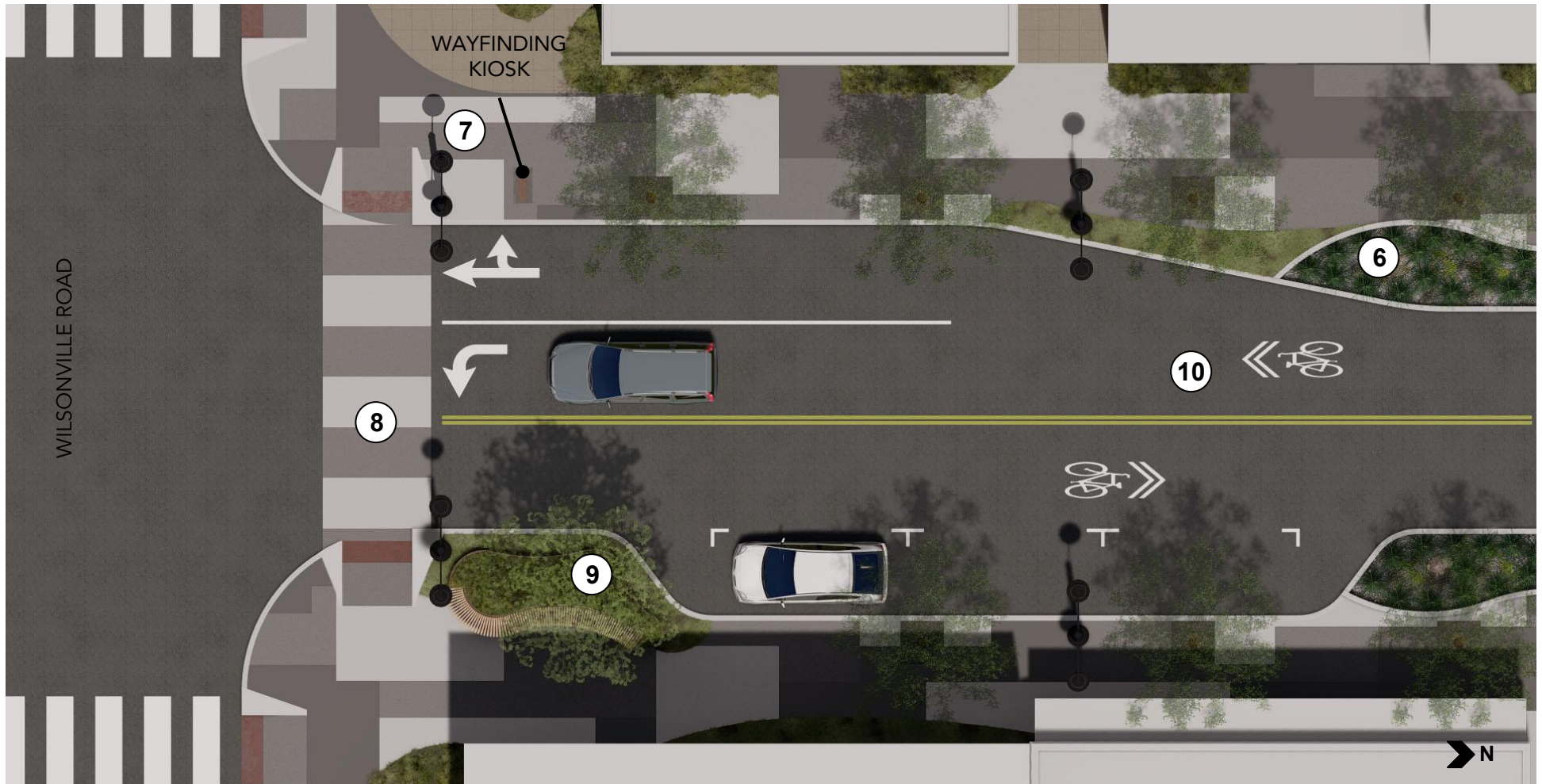

6. CURB EXTENSIONS

Along the Park Place Extension

Integrated seating

Planting bed and stormwater areas

7. SIDEWALK DESIGN

Signature pattern-formed concrete throughout

8. CROSSWALKS

Signature pattern-formed concrete on the crossing of Park Place

CorTen pads

9. LANDSCAPE

Trees in tree grates at 30 foot spacing along the street

Plantings and stormwater in curb extensions

10. BIKE FACILITIES

Shared travel in regular vehicle lanes

"Shared lane" markings

LOCATION IN.8: TOWN CENTER LOOP WEST

(Wilsonville Road to Parkway Ave)

TRANSFORMING A BASIC ROAD INTO A COMMUNITY-SERVICE STREET

Currently a four-lane boulevard separated by a planted median and punctuated by left-turn pockets, Town Center Loop West will be transformed into a local-service street that better supports growing uses on nearby properties and makes the street more welcoming for people to walk and bike along.

TOWN CENTER PLAN FUNDAMENTALS

- The Town Center Plan calls for general improvements to the street and a range of several design configurations based on future urban development context (including an option to vacate the street entirely and turn it over to redevelopment).
- The City is currently working on a street improvement project for Town Center Loop that will add protected bike lanes as part of the restriping and repaving of the street. Once the Park Place extension is complete, the city plans to convert the bike lanes on Town Center Loop to on-street parking as cycling facilities will be provided elsewhere. The illustrations of Town Center Loop are reflective of the configuration planned for the road after Park Place is extended.

IMPLEMENTATION BASICS

- Construct the street in a series of phases linked to the private development of adjacent properties.
- Tactically remove the interim street improvements as complete new street construction comes online in phases.



INVESTMENT LEVEL
SIGNATURE
ENHANCED
STANDARD

LOCATION IN.8: TOWN CENTER LOOP WEST

(Wilsonville Road to Parkway Ave)

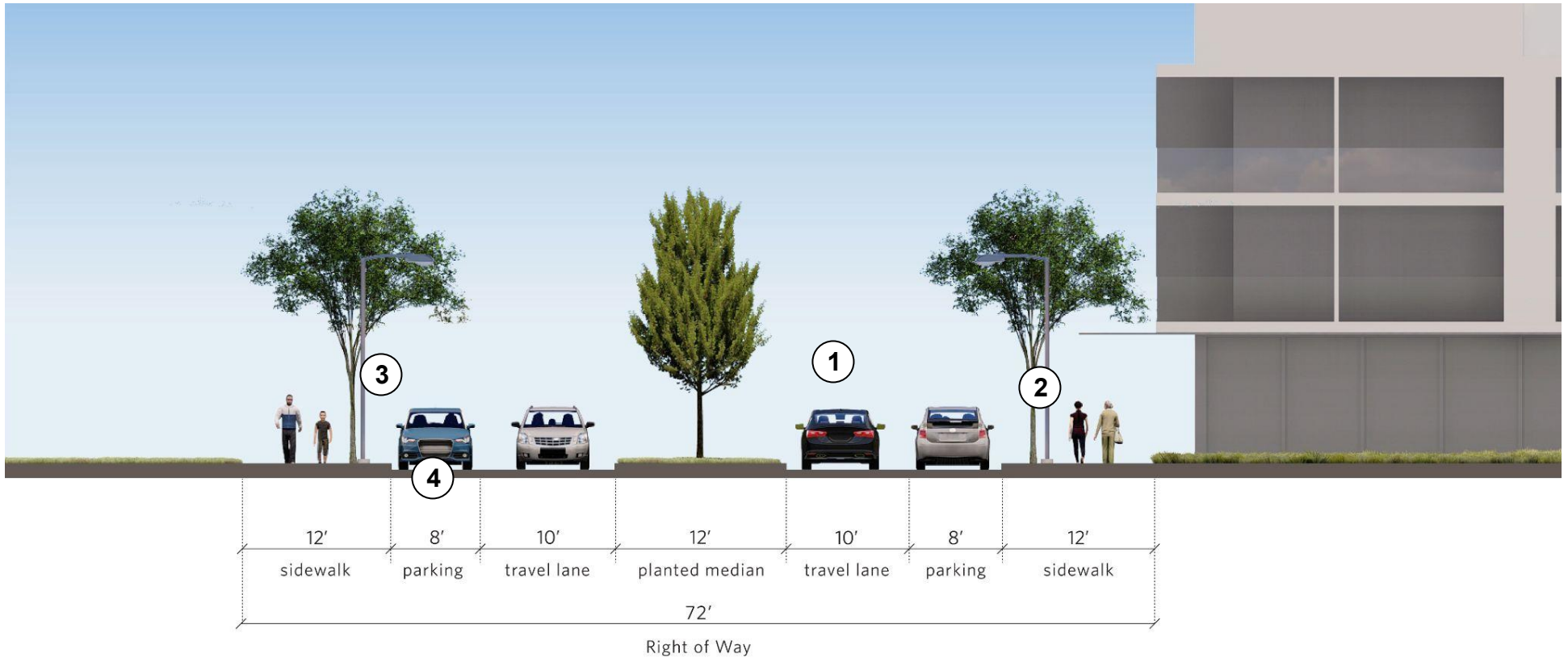

1. STREET ZONE

Two-way traffic in a boulevard-style street with a center median and turn pockets

On-street parking and parklet options

2. SEATING

Standard bench installed in suitable locations - regular and frequent spacing in the furnishing zone

3. LIGHTING

Single-headed cobra light (existing) is planned to be retained for lighting

4. STORMWATER

Stormwater catchment in curb extensions (in place of parking at intersections)

5. TRANSIT

No transit service or stations planned in this location

LOCATION IN.8: TOWN CENTER LOOP WEST

(Wilsonville Road to Parkway Ave)

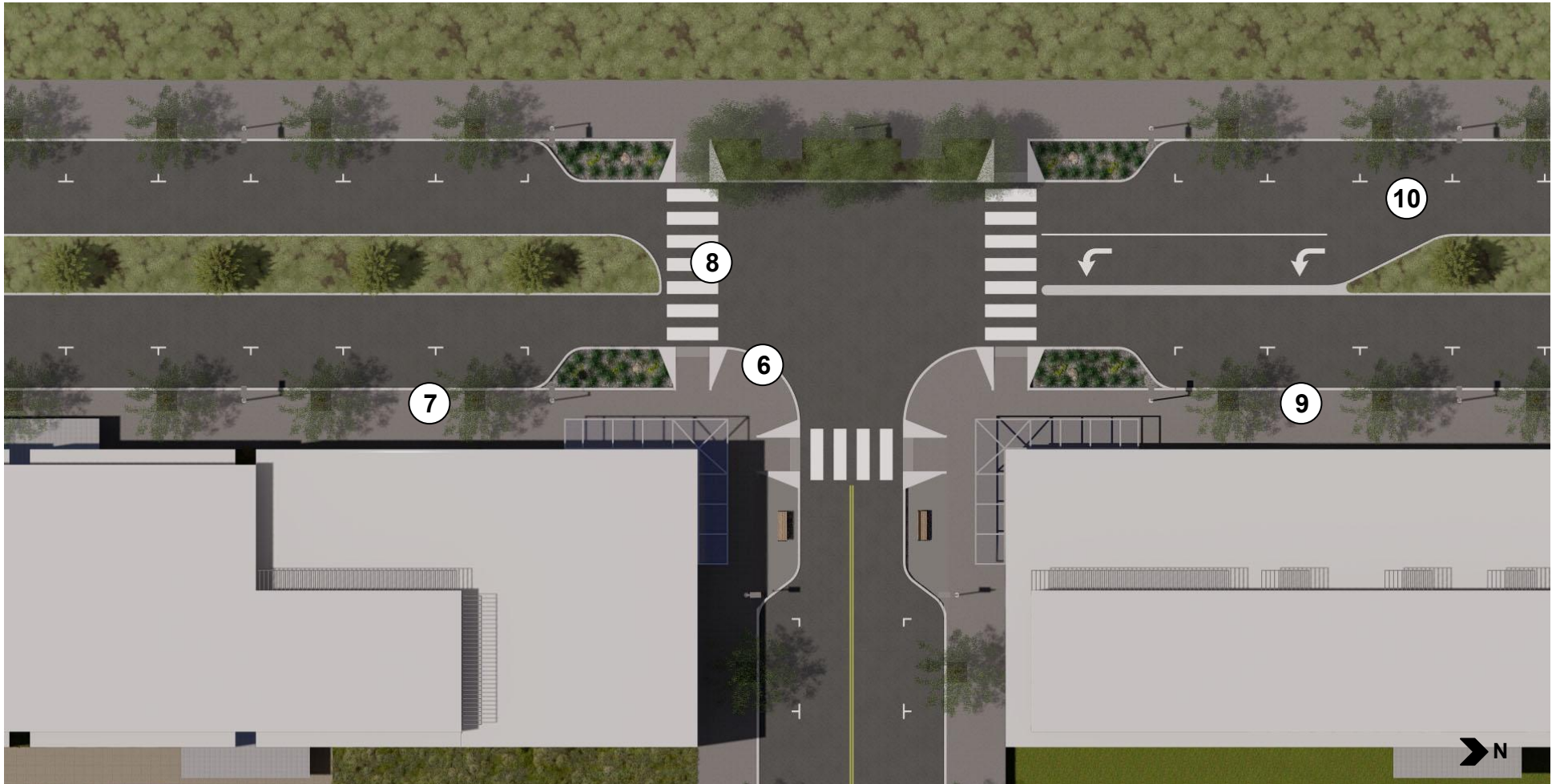

6. CURB EXTENSIONS

Along Town Center Loop West and intersecting streets

Hold Standard seating and stormwater areas

7. SIDEWALK DESIGN

Standard concrete design

8. CROSSWALKS

Standard "continental stripe" crosswalks

9. LANDSCAPE

Trees in tree grates at 30 foot spacing along the street

Retain existing median with trees

10. BIKE FACILITIES

No marked bike facilities, but bikes may use the regular travel lane

LOCATION IN.9: LOCAL STREET

(Typical, non-specific location)

CONNECTING A NEW STREET GRID TO SERVE THE TOWN CENTER

New development and a finer-grained block structure in the Town Center will require the addition of new Local Streets. These streets will be constructed as part of private development and will generally include wide sidewalks with street trees, vehicle travel lanes, and on-street parking with stormwater catchment and buffered bikeways (as illustrated).

TOWN CENTER PLAN FUNDAMENTALS

- A network of new local streets providing multimodal access to sites and defining a smaller block grid of under 400'
- Local streets connect to the existing network and often route through locations of existing parking lots
- The 60 feet right-of-way shown accommodates two vehicle lanes, on-street parallel parking, stormwater and landscape, bike lanes and wide sidewalk areas.
- Other design options include on-street parking instead of bike lanes or a 54 foot right-of-way Woonerf-style shared street. (See the Town Center Plan Appendix D).

IMPLEMENTATION BASICS

- Construct as part of private development, with private landowner assuming the majority of costs
- Dedicate new right-of-way during the development review process.

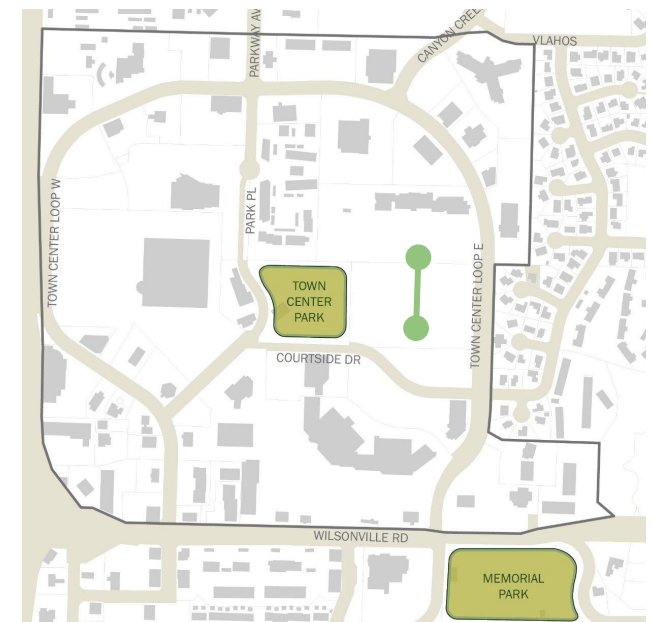

INVESTMENT LEVEL
SIGNATURE
ENHANCED
STANDARD

LOCATION IN.9: LOCAL STREET

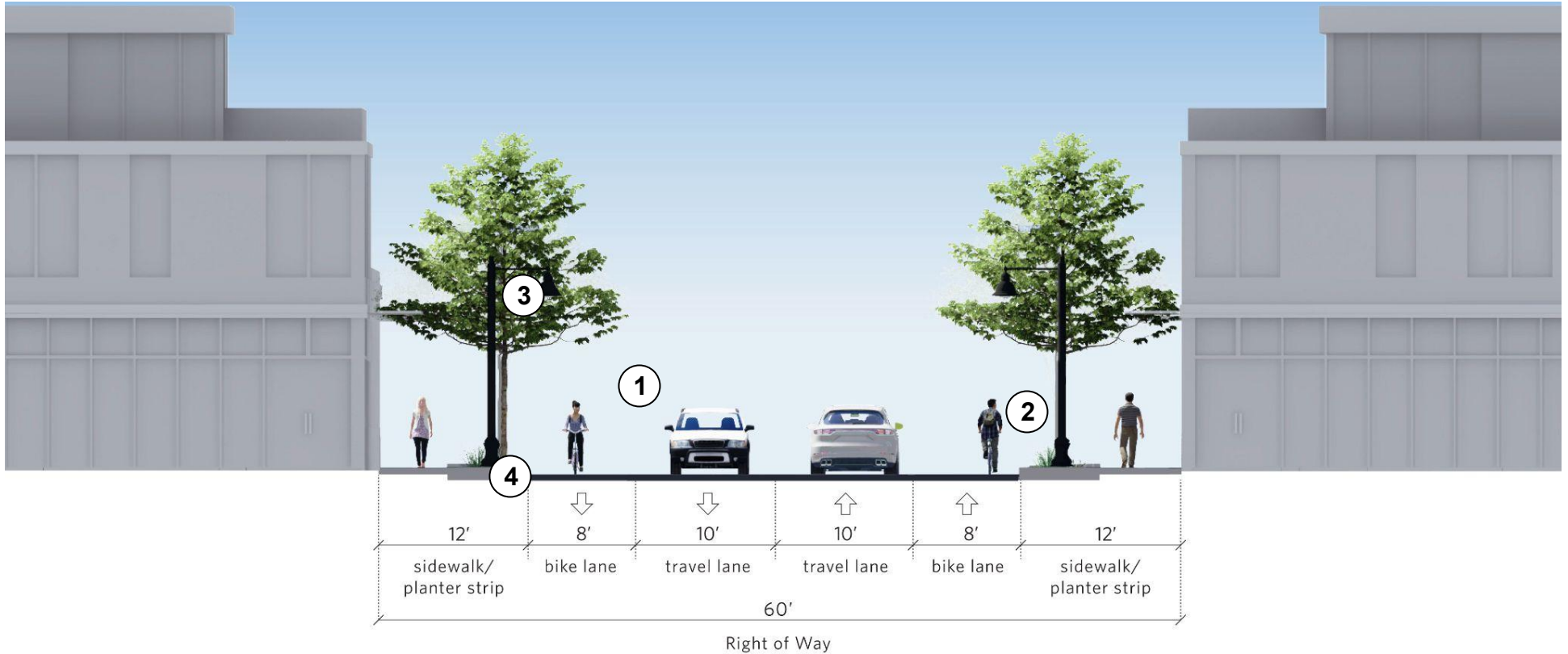

1. STREET ZONE

Two-way traffic flow
Buffered bikes lanes in both directions

2. SEATING

Standard bench installed in suitable locations - seek regular and frequent spacing in the furnishing zone

3. LIGHTING

Single-headed lighting spaced at 60 foot intervals along both sides of the entire street

4. STORMWATER

Stormwater catchment in infiltration planters in the sidewalk furnishing zone

5. TRANSIT

No transit service or stations planned in this location

LOCATION IN.9: LOCAL STREET

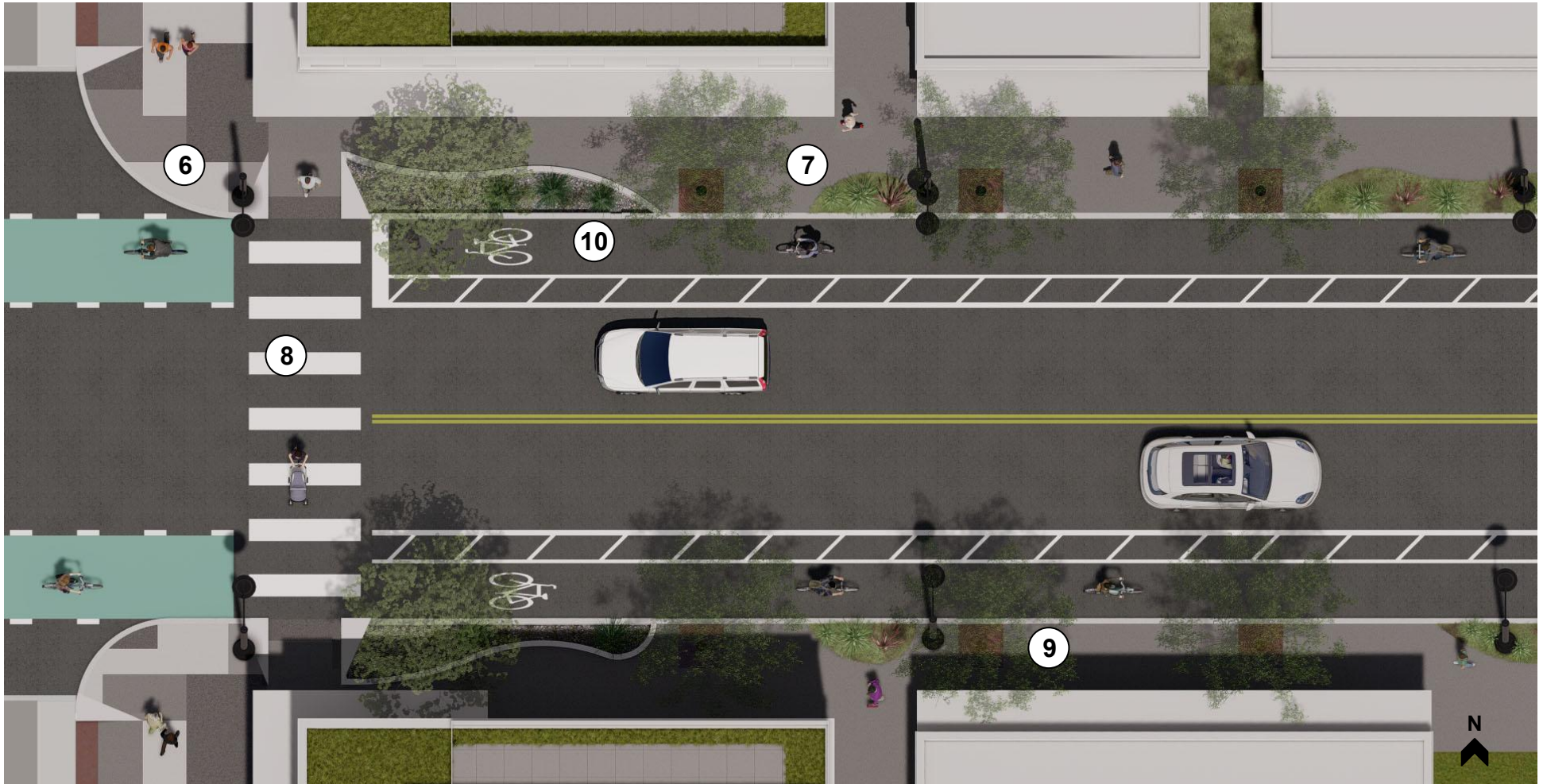

6. CURB EXTENSIONS

No curb extensions in the shown Local Street configuration (which uses bike lanes)

7. SIDEWALK DESIGN

Standard concrete design

8. CROSSWALKS

Standard "continental stripe" crosswalks

9. LANDSCAPE

Trees in tree grates at 30 foot spacing along the street
Plantings near corners and curb extensions (if present)

10. BIKE FACILITIES

Buffered bike lanes
Marked bike lanes through intersections with green paint and striping

LOCATION IN.12: PROMENADE

(Park Ave westward towards I-5 Bicycle and Pedestrian Bridge) (Framework Project)

A LINEAR PARK CREATING KEY CONNECTIONS

The Promenade functions as much as a park as it does a street, and it will not permit motor vehicle passage. This is an important connection between the Park Place main street and the in-progress I-5 bicycle and pedestrian bridge. The Promenade provides spacious pedestrian ways and a buffered two-way bicycle route helping to link the Emerald Chain through the Town Center. This prototype may inform the design of other multimodal streets in Town Center.

TOWN CENTER PLAN FUNDAMENTALS

- Framework (high priority) Project.
- Linear park with landscape and plantings throughout.
- A walking promenade, sidewalk, and bikeway provide access through the Promenade and to businesses and residents.
- No motor vehicle traffic allowed.

IMPLEMENTATION BASICS

- Coordinate alignment with related projects including Fry's site redevelopment and the I-5 bicycle and pedestrian bridge landing plaza, as well as transitions from the Promenade (which prohibits cars) to Park Avenue (which permits cars).
- Construct as a partnership between the City and private landowners as adjacent sites are redeveloped.
- Align locations of planters, sidewalks, and passageways to ensure not to block access to building entrances.

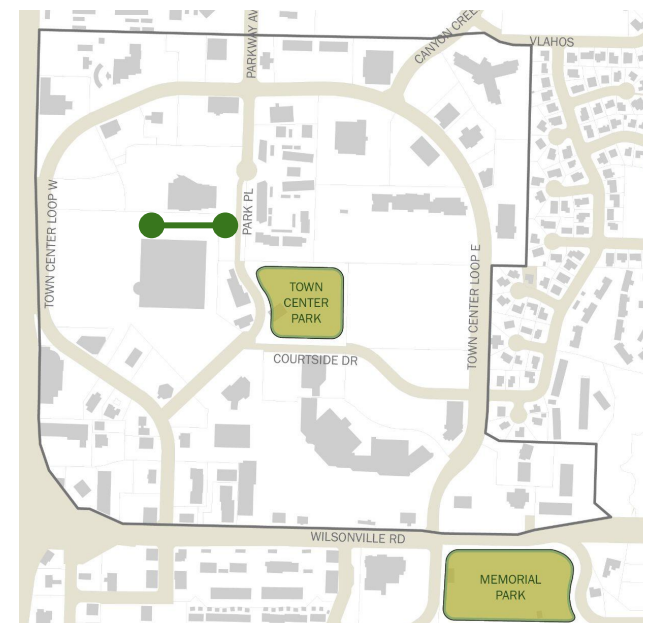

INVESTMENT LEVEL
SIGNATURE
ENHANCED
STANDARD

LOCATION IN.12: PROMENADE

(I-5 Bicycle and Pedestrian Bridge eastward to Park Ave) (Framework Project)

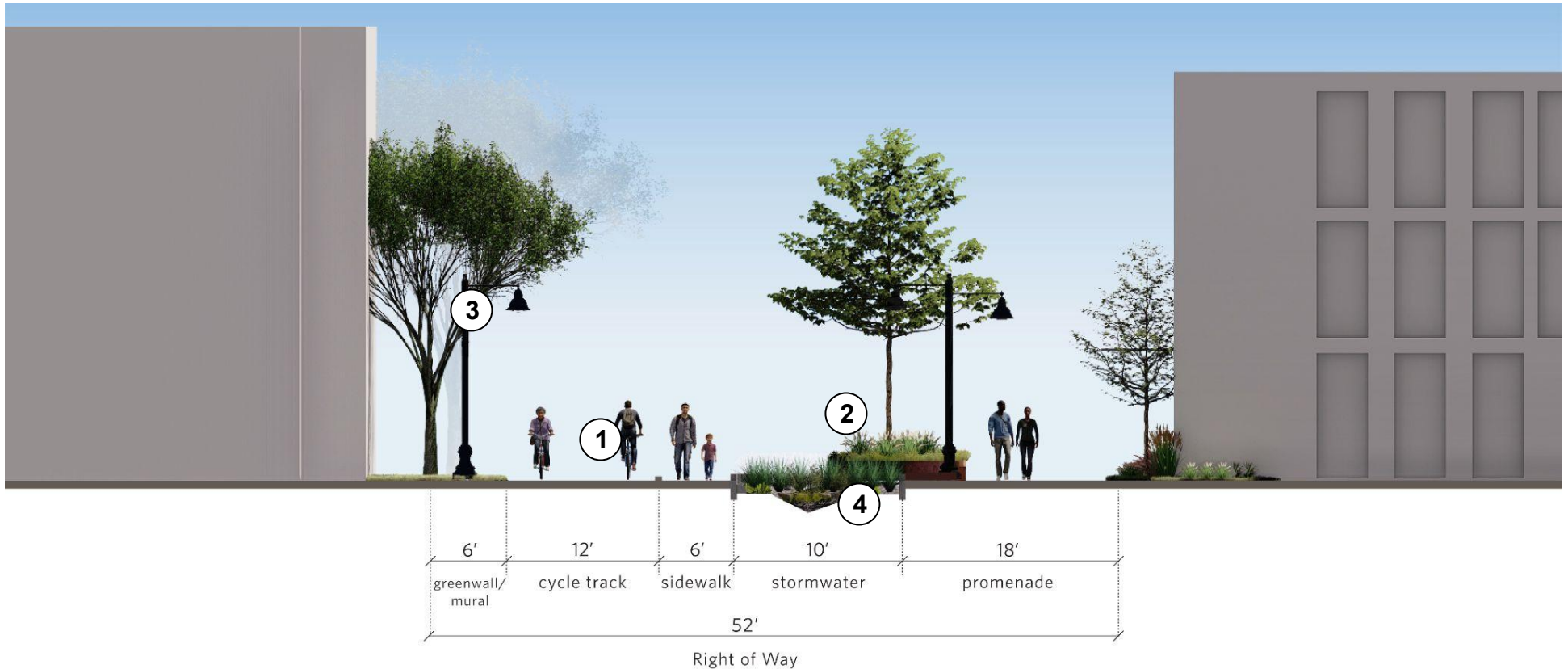

1. STREET ZONE

No motor vehicles allowed (except emergency services)
Promenade and sidewalk for people walking
Two-way cycletrack along north side

2 SEATING

Signature benches built into planters and stormwater areas throughout
Standard and Enhanced benches may also be used in suitable locations

3. LIGHTING

Double-headed lighting spaced at 60 foot intervals along the length of the Promenade illuminating the cycletrack, sidewalk, and promenade

10. STORMWATER

Integrated stormwater facilities run through the center of the Promenade - features seating and abundant landscape

5. TRANSIT

No transit service or stations planned in this location

LOCATION IN.12: PROMENADE

(Park Ave westward towards I-5 Bike and Pedestrian Bridge) (Framework Project)

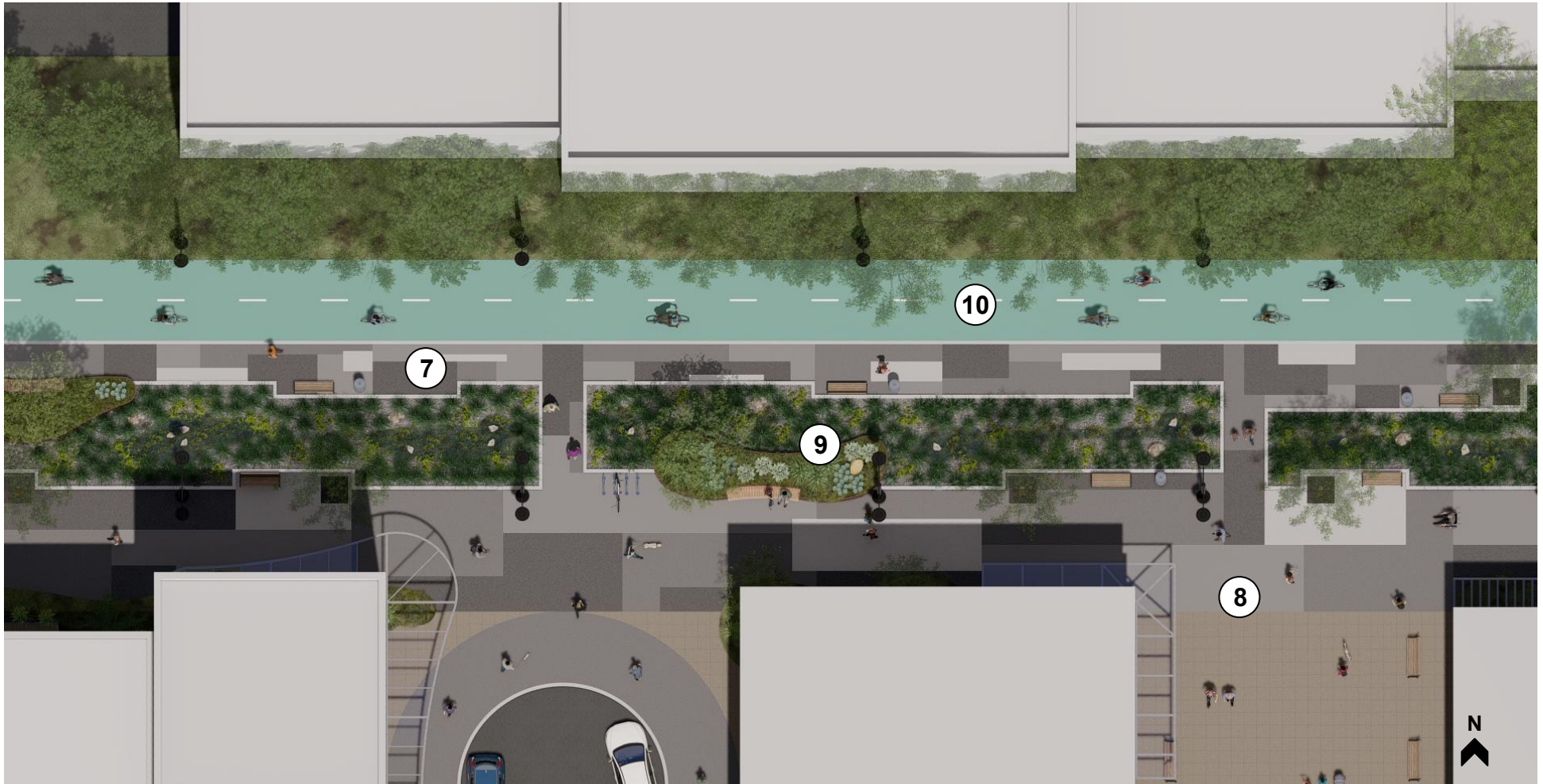

CURB EXTENSIONS

No curb extensions in the Promenade, but they will be used at intersecting streets such as Park Place to the east

7. SIDEWALK DESIGN

Promenade and sidewalk zones use the Signature concrete pattern

8. TRANSITION ZONE

Promenade connects to side streets and private plazas - surface materials and furnishings can blend across

9. LANDSCAPE

Trees, bushes, and grasses throughout planting areas
Tailor the plant selection to stormwater function needs

10. BIKE FACILITIES

Separated two-way cycletrack connection as part of the Emerald Chain

PLAZA AND PRIVATE OPEN SPACE DESIGN

(Locations throughout Town Center)

LINKING STREETSCAPE DESIGN TO SITE DEVELOPMENT

The Town Center Plan reflects the community's ambitions for a vastly transformed Town Center, both in public streets and on private properties. The City's design guidance and development standards for private property encourage plazas, courtyards, entryway vestibules, and other semi-public spaces. Those areas can use many of the same or complementary furnishing products and materials as the streetscape, helping ensure design consistency and harmony throughout the outdoor places in Town Center.

PLAZA DESIGN ELEMENTS

- Surface Material. Plazas may use a combination of conventional concrete similar to the Standard option, pavers that match the Western Interlock product used in Enhanced sidewalks, and/or the custom concrete formwork of the Signature sidewalk pattern. These can be used as primary surface materials or as accent materials at focal points or transitions.
- Lighting. Any configuration of the Rama may be used in private plazas and open space. If PGE Option A equipment is utilized nearby, the PGE product may be extended into the space. Other equipment may be approved by City staff, and should be contemporary in design.
- Seating. Plazas may contain a range of seating options, from the Standard bench to Signature built-in seating, and other variations such as natural stone. For example, owners may customize shapes and sizes of the Streetlife Rough&Ready benches.
- Bollards. The Streetlife Solid Quattro bollard is suitable to install at plaza edges to define the space and provide protection from errant vehicles.

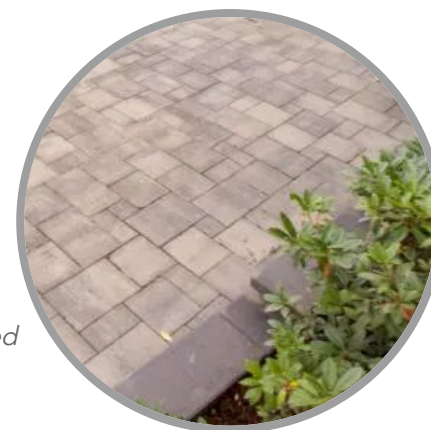

Pavers can be used throughout or as accent in plazas



Streetlife Rough&Ready Tree Isles are configurable in many shapes and sizes suitable for use in plazas.

appendices

Appendix A. Preliminary Concepts Material

Appendix B. Public Involvement Summary

Appendix C. Transportation System Plan 2020 Update Summary

Appendix D. Signage and Wayfinding Plan Summary

Appendix E. Product and Material Specification Sheets

appendix A: preliminary concept materials

RECOMMENDED CONCEPT REVIEW

CITY COUNCIL

APRIL 5, 2021



WILSONVILLE TOWN CENTER STREETSCAPE PLAN

RECOMMENDED CONCEPT ELEMENTS

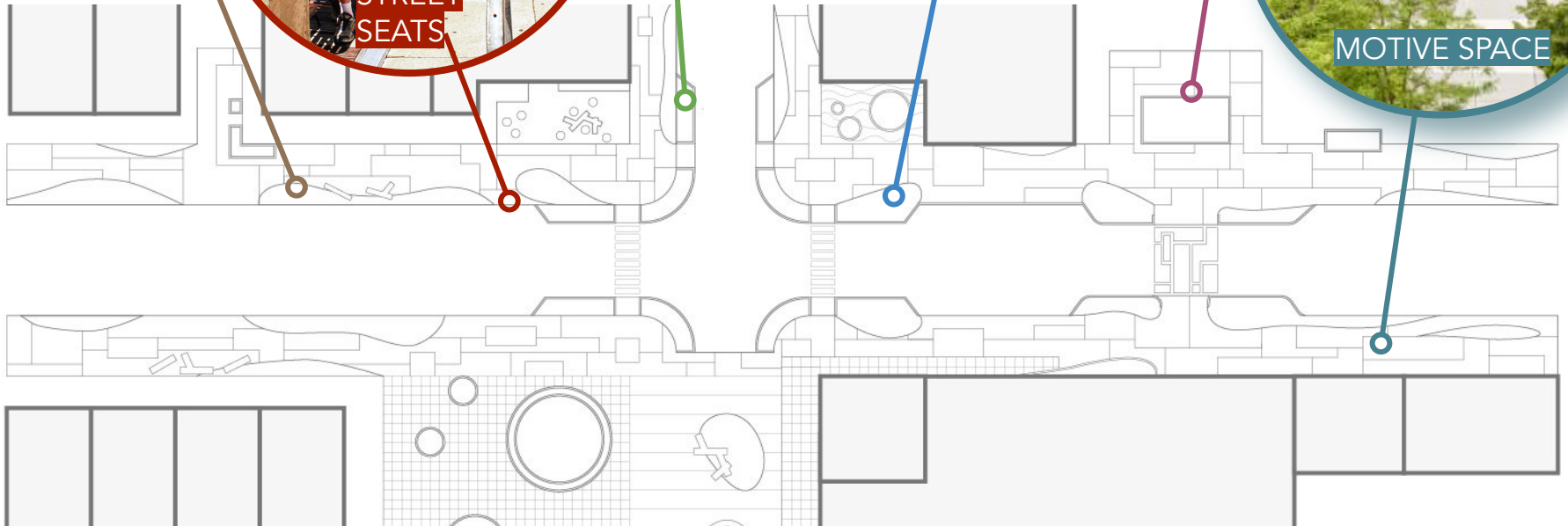

RECOMMENDED CONCEPT

APPENDIX A: PRELIMINARY CONCEPTS MATERIAL



RECOMMENDED CONCEPT

APPENDIX A: PRELIMINARY CONCEPTS MATERIAL



RECOMMENDED CONCEPT

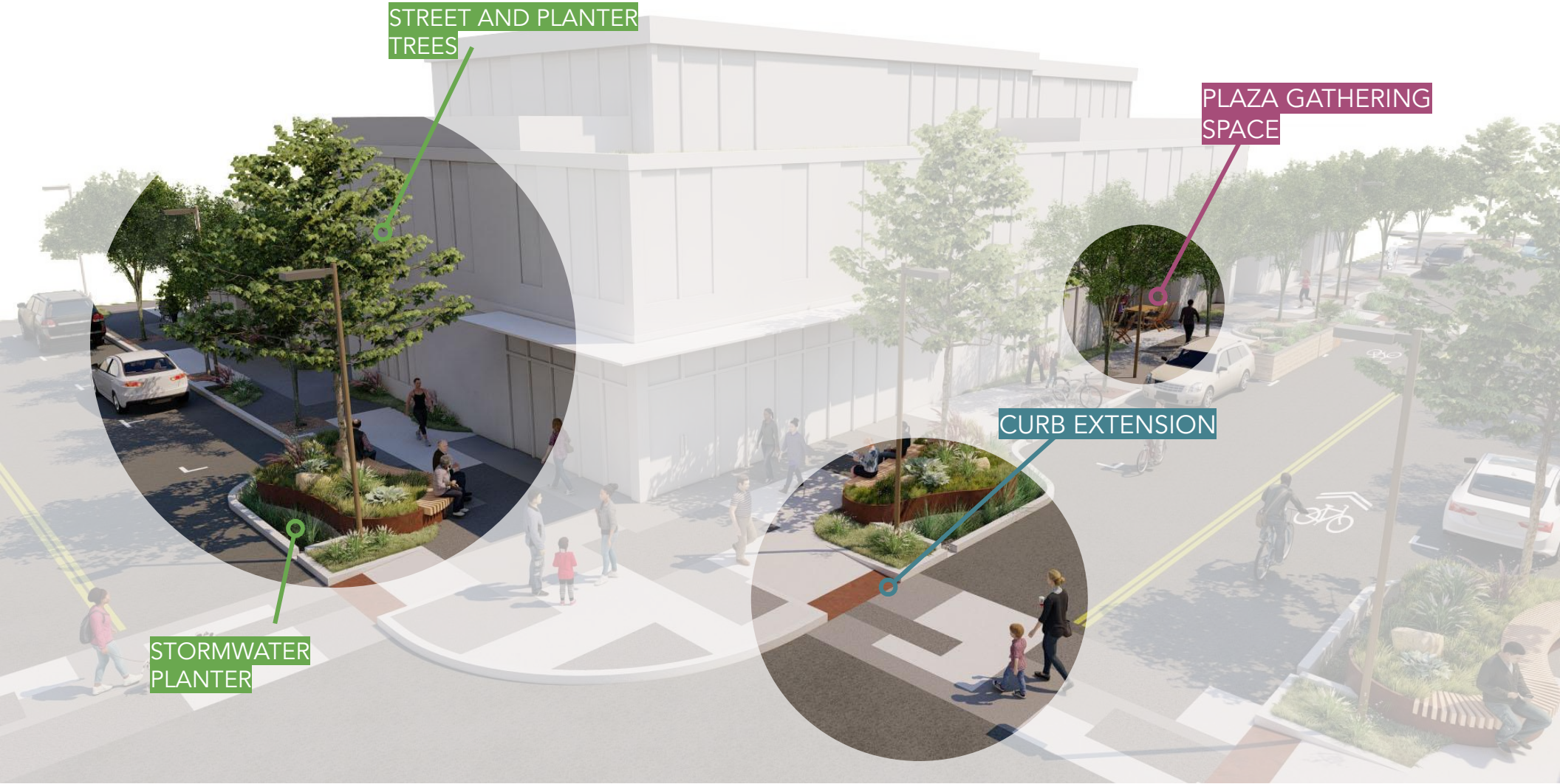

RECOMMENDED CONCEPT

APPENDIX A: PRELIMINARY CONCEPTS MATERIAL



Do you support us moving ahead with the Recommended Street Design Concept?

Do you have any additional comments or suggestions to offer about the Recommended Concept?

RECOMMENDED CONCEPT: RIVER + TECHNOLOGICAL

NATURAL - CONTRAST - MODULARITY



- Gathering Space*
- Landmark/Public Art/Transit Stop*
- Landscape Area*
- Motive Space*

***Concept diagrams are not intended to show an actual to-scale design. Instead, this is an abstract depiction of how streetscape elements can be arranged with arrows representing movement through space, and colored blocks represent street elements.*

RECOMMENDED CONCEPT: RIVER + TECHNOLOGICAL

NATURAL - CONTRAST - MODULARITY

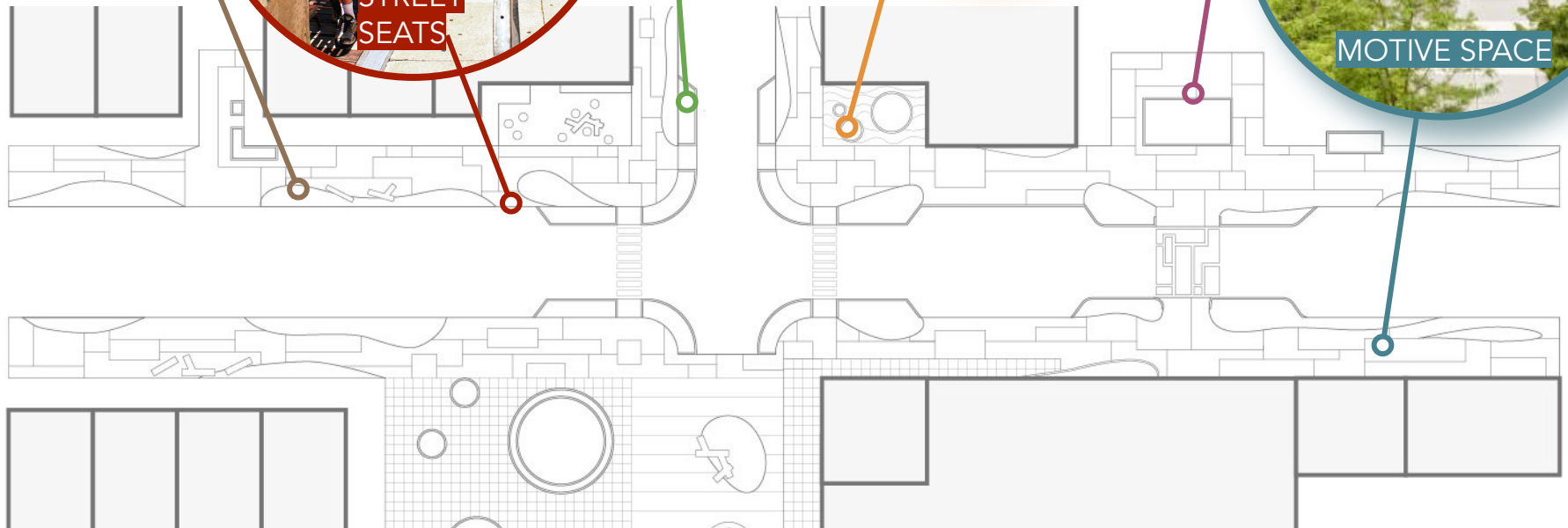

RECOMMENDED CONCEPT: RIVER + TECHNOLOGICAL

NATURAL - CONTRAST - MODULARITY

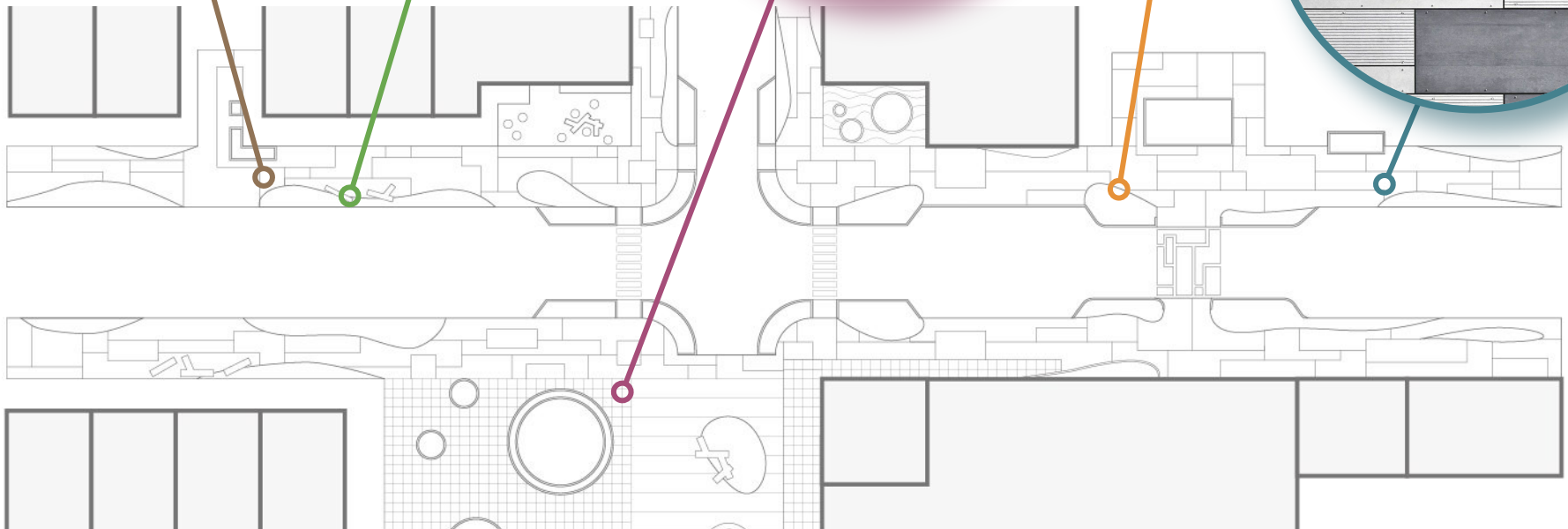
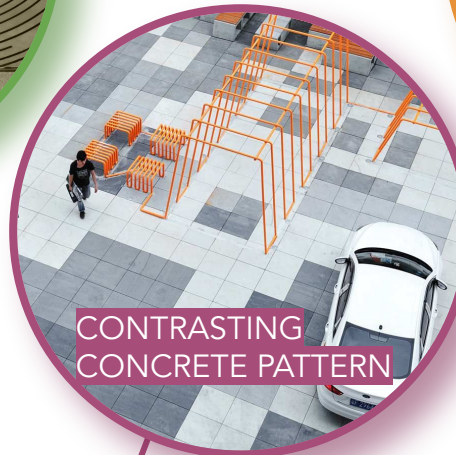

RECOMMENDED CONCEPT: RIVER + TECHNOLOGICAL

NATURAL - CONTRAST - MODULARITY

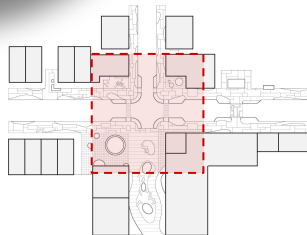



DESIGN CONCEPT COMPARISON

Concept 1: Agriculture

Concept 2: Technology

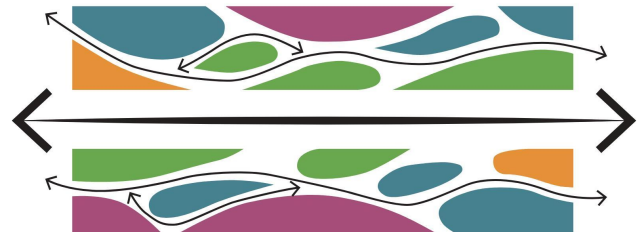
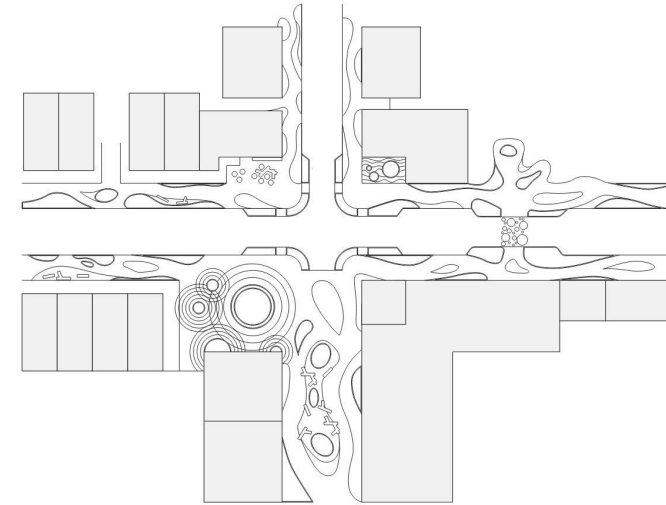
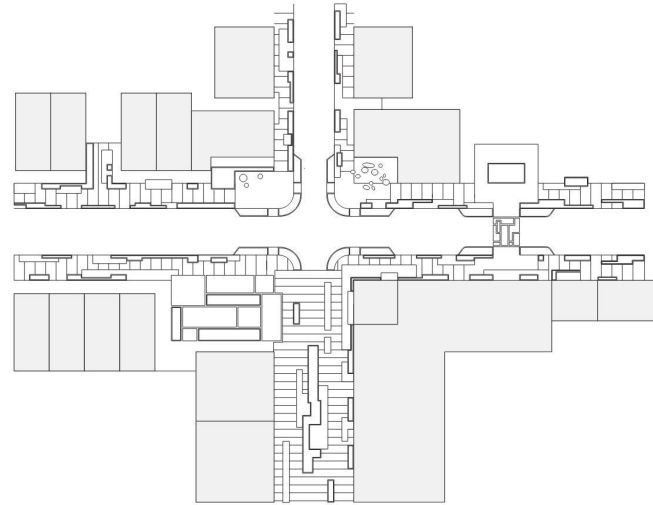
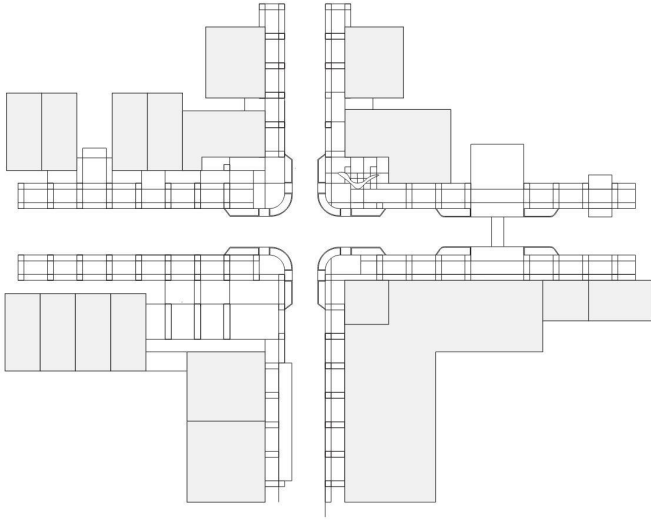
Concept 3: River



-  *Gathering Space*
-  *Landmark/Public Art/Transit Stop*
-  *Landscape Area*
-  *Motive Space*

COMMUNITY FORUM #2

FEBRUARY 9, 2021



WILSONVILLE TOWN CENTER STREETSCAPE PLAN

TOWN CENTER STREETScape DESIGN

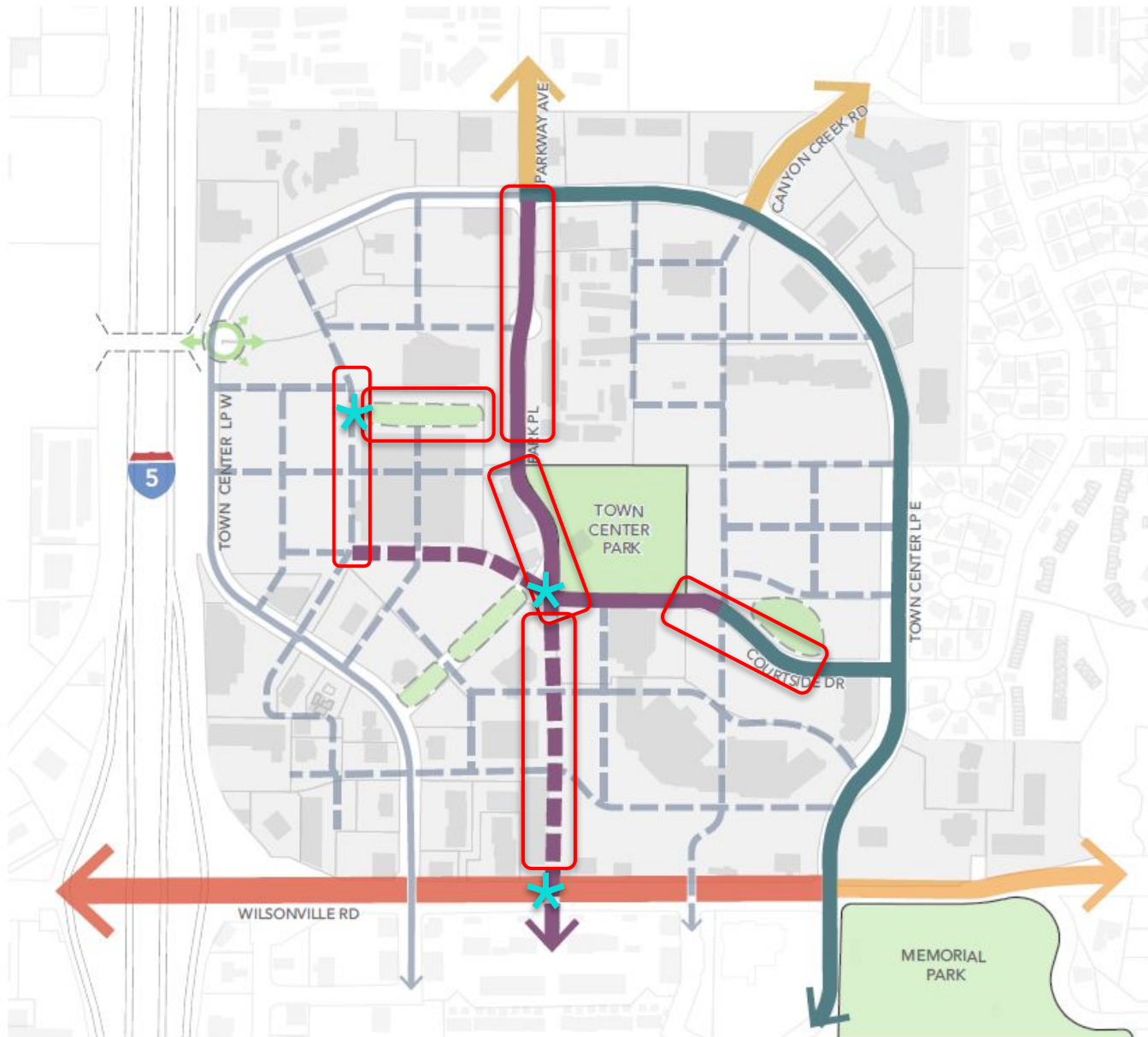

- Up to 8 street type designs (some types may get more than one design option)
- * Up to 3 unique location designs

STREETSCAPE PLAN
Prepare a unified design concept that is then tailored to different street types and specific unique locations

CONCEPT DIAGRAM: AGRICULTURAL LEGACY



***Concept diagrams are not intended to show an actual to-scale design. Instead, this is an abstract depiction of how streetscape elements can be arranged with arrows representing movement through space, and colored blocks represent street elements.*

SPACE TYPOLOGY: AGRICULTURAL LEGACY

PURPOSEFUL - STRUCTURED - TIMELESS

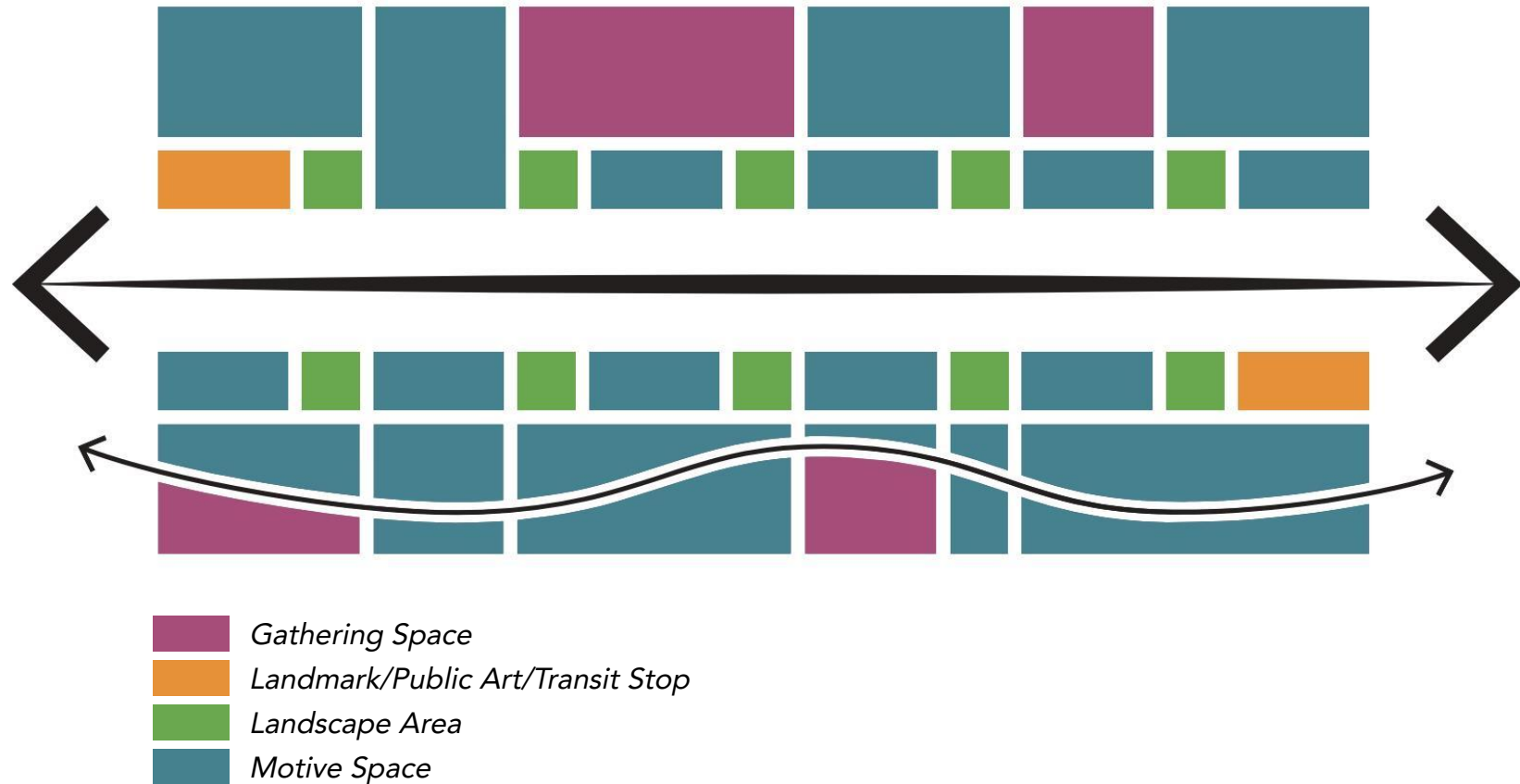

***Concept diagrams are not intended to show an actual to-scale design. Instead, this is an abstract depiction of how streetscape elements can be arranged with arrows representing movement through space, and colored blocks represent street elements.*

DESIGN CONCEPT: AGRICULTURAL LEGACY

PURPOSEFUL - STRUCTURED - TIMELESS

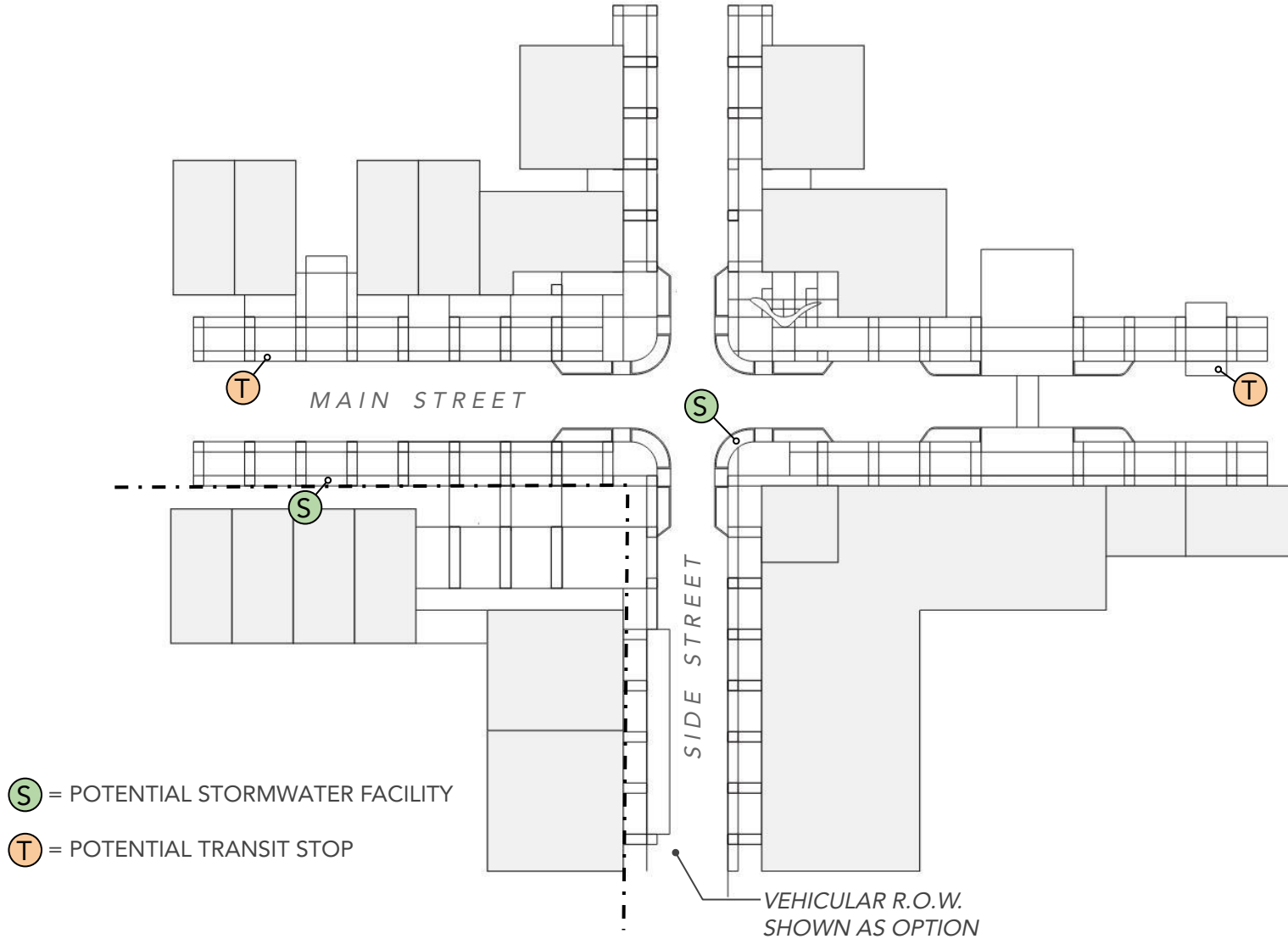

DESIGN CONCEPT: AGRICULTURAL LEGACY

PURPOSEFUL - STRUCTURED - TIMELESS

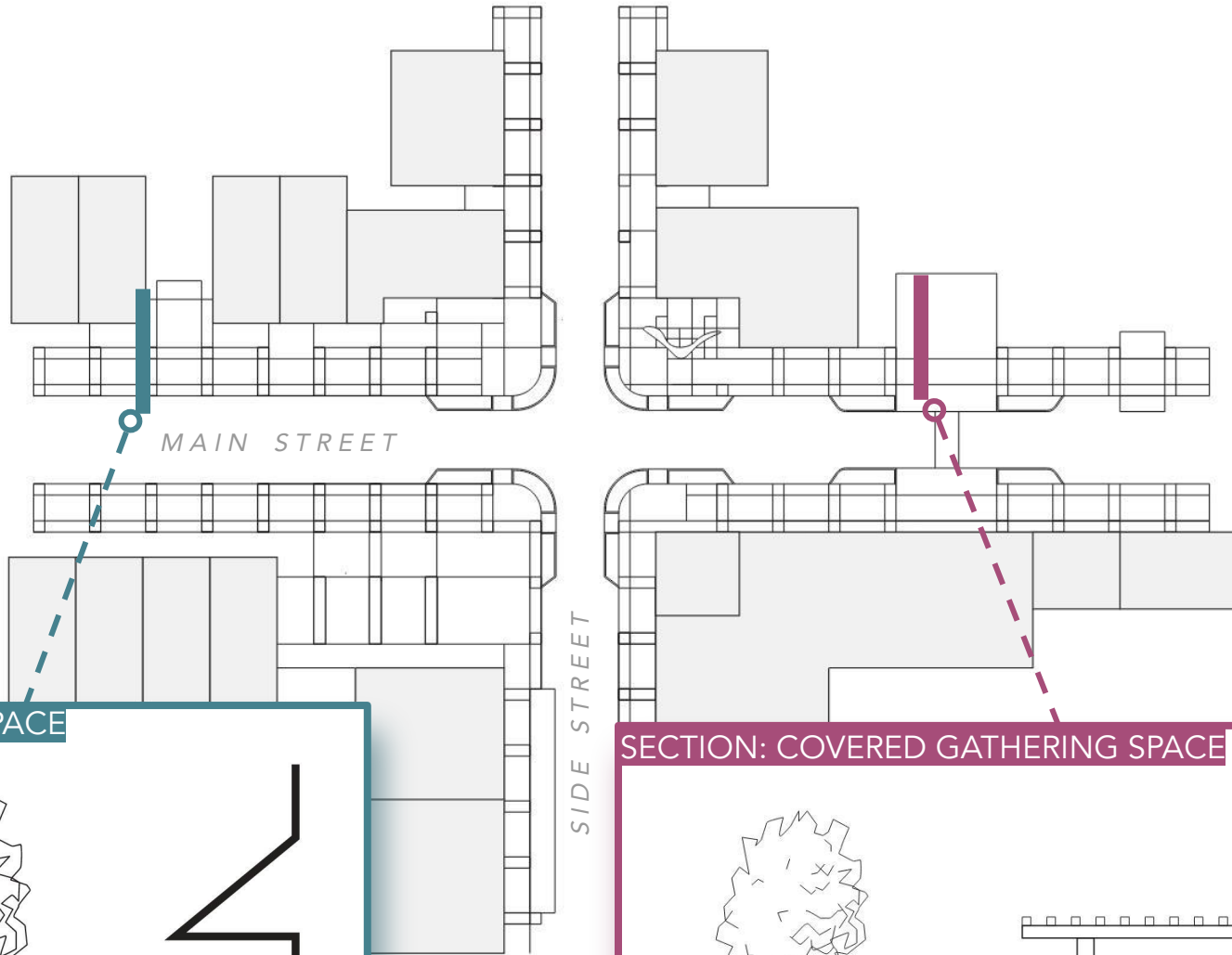

SECTION: MOTIVE SPACE

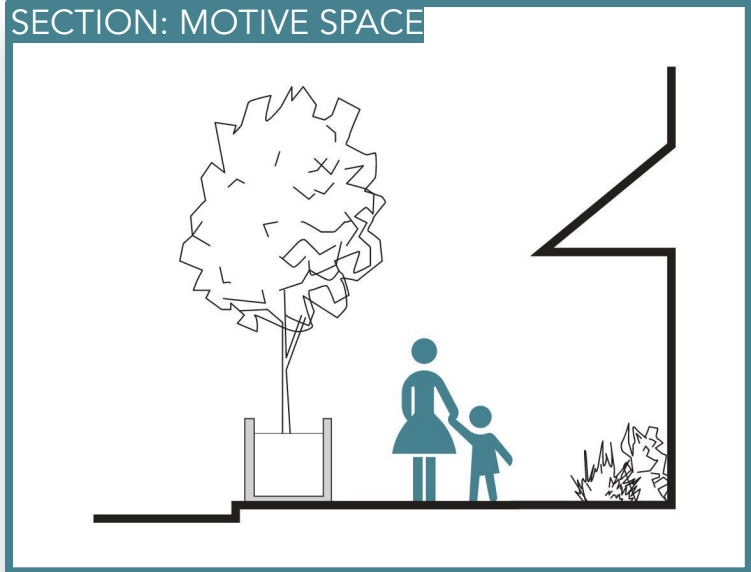

SECTION: COVERED GATHERING SPACE

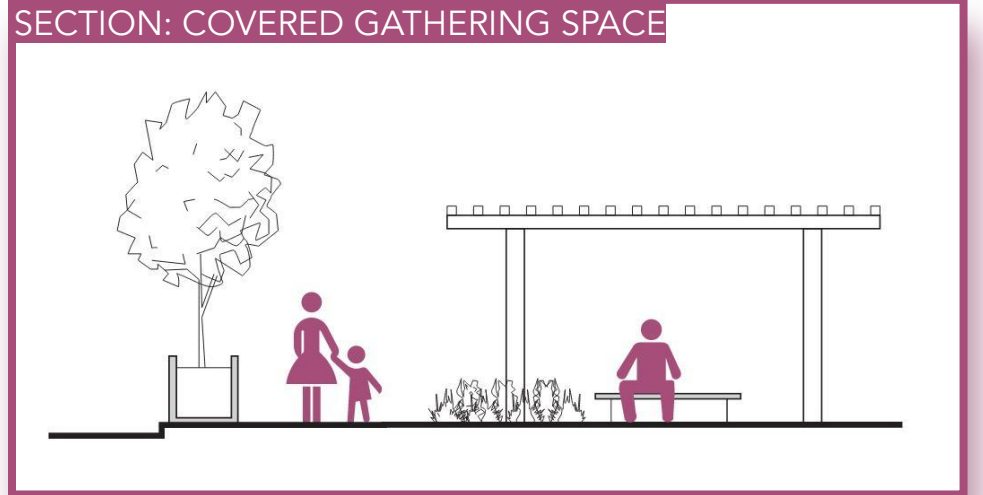

DESIGN CONCEPT: AGRICULTURAL LEGACY

PURPOSEFUL - STRUCTURED - TIMELESS

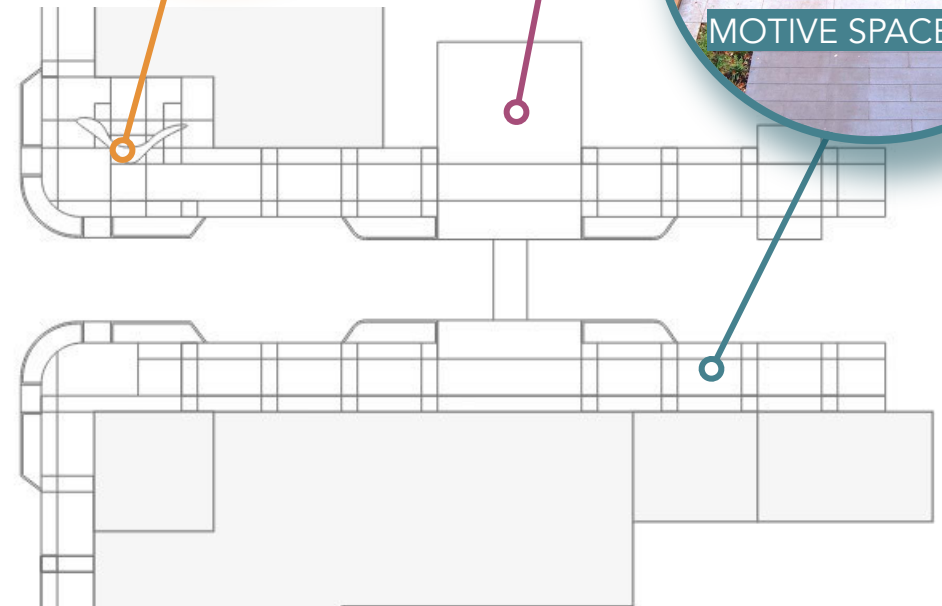
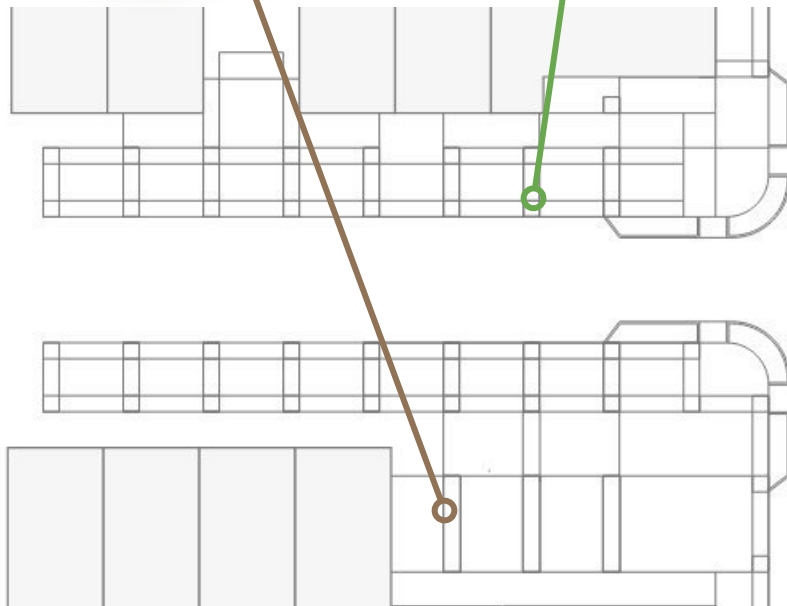

MATERIALS: AGRICULTURAL LEGACY

PURPOSEFUL - STRUCTURED - TIMELESS

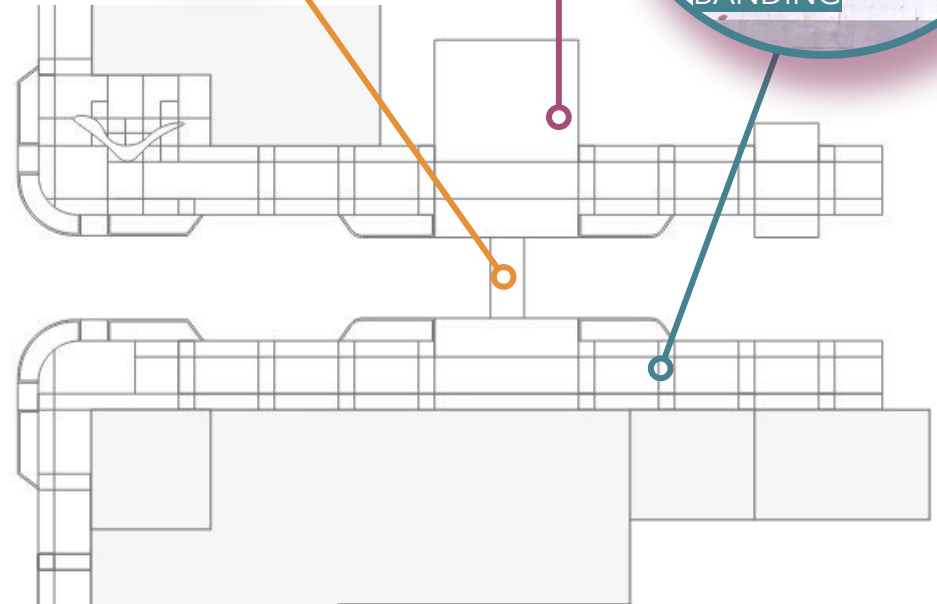
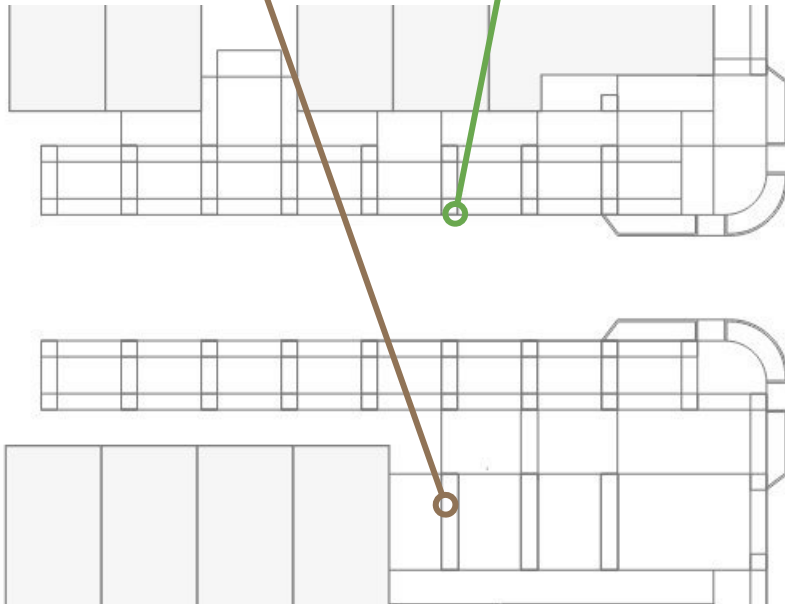

INTERSECTION DESIGN: AGRICULTURAL LEGACY

PURPOSEFUL - STRUCTURED - TIMELESS

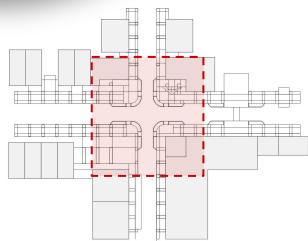
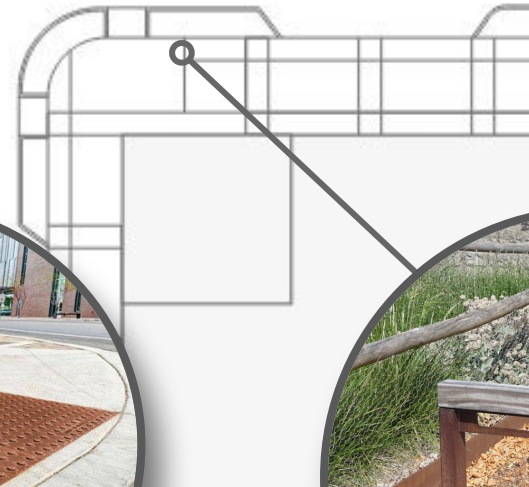
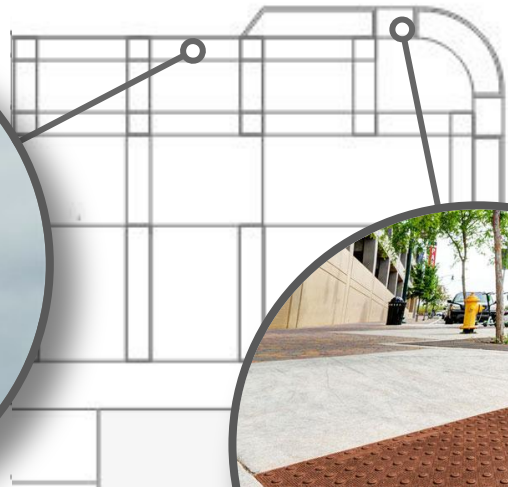
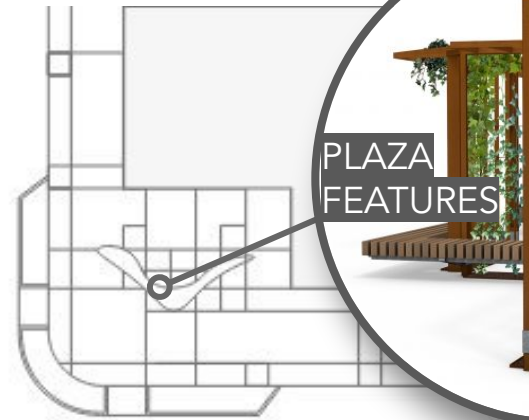
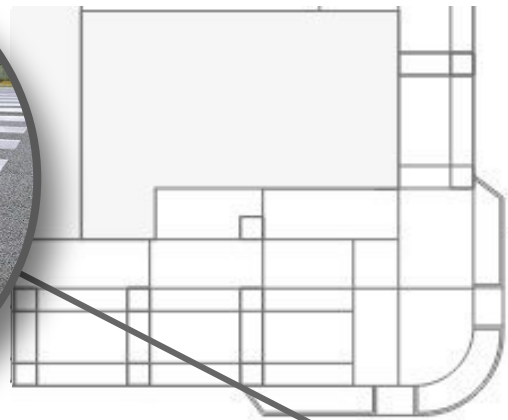

DESIGN CONCEPT: TECHNOLOGICAL INNOVATION

MODULARITY - SIMPLICITY - CONTRAST

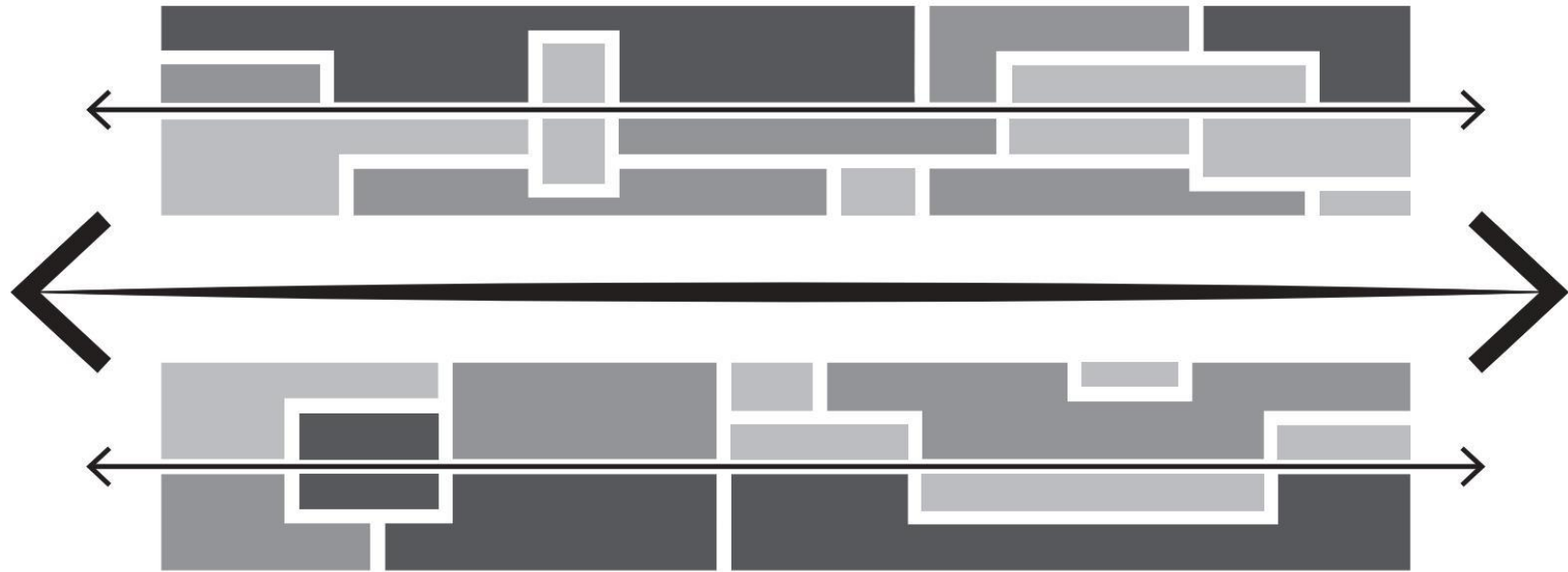

***Concept diagrams are not intended to show an actual to-scale design. Instead, this is an abstract depiction of how streetscape elements can be arranged with arrows representing movement through space, and colored blocks represent street elements.*

DESIGN CONCEPT: TECHNOLOGICAL INNOVATION

MODULARITY - SIMPLICITY - CONTRAST



***Concept diagrams are not intended to show an actual to-scale design. Instead, this is an abstract depiction of how streetscape elements can be arranged with arrows representing movement through space, and colored blocks represent street elements.*

DESIGN CONCEPT: TECHNOLOGICAL INNOVATION

MODULARITY - SIMPLICITY - CONTRAST

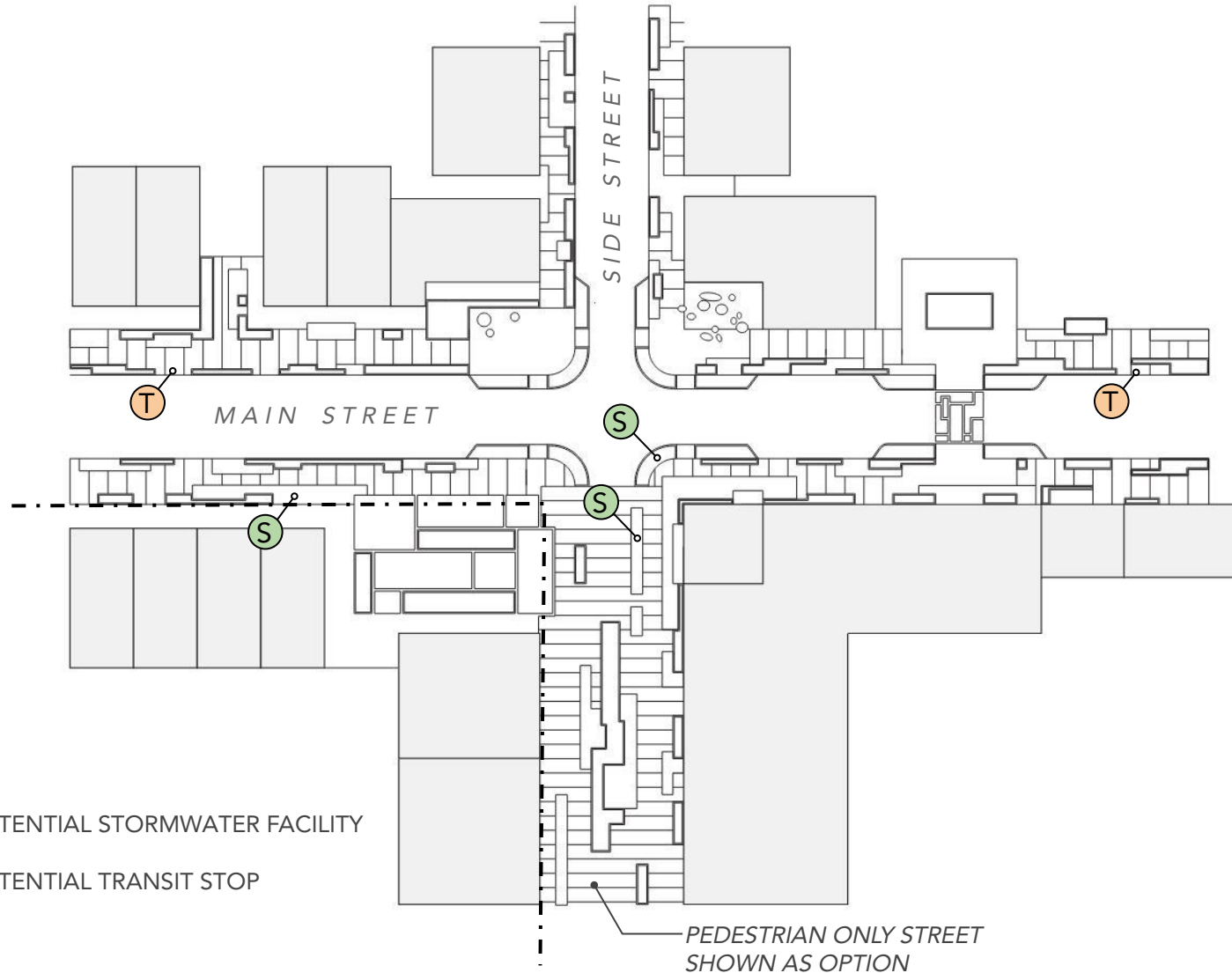

- Ⓢ = POTENTIAL STORMWATER FACILITY
- Ⓣ = POTENTIAL TRANSIT STOP

DESIGN CONCEPT: TECHNOLOGICAL INNOVATION

MODULARITY - SIMPLICITY - CONTRAST

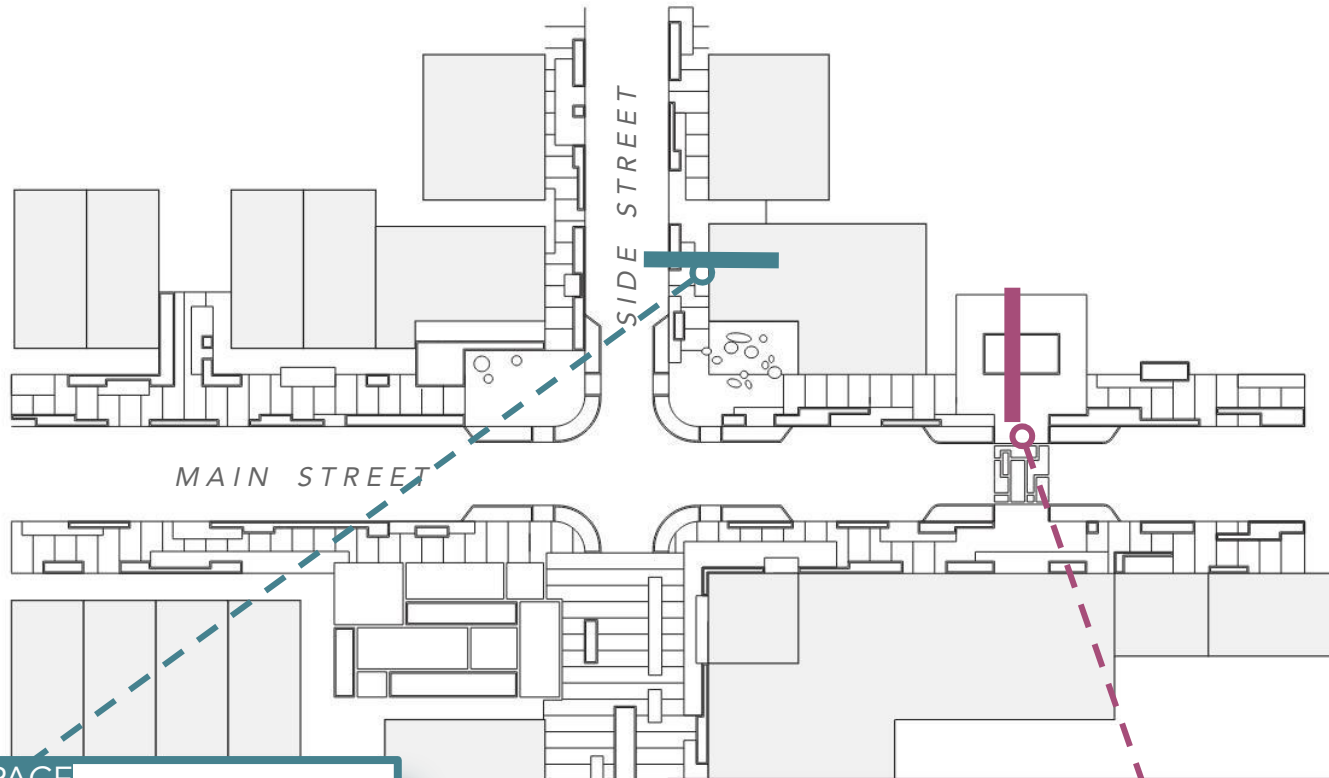

SECTION: MOTIVE SPACE

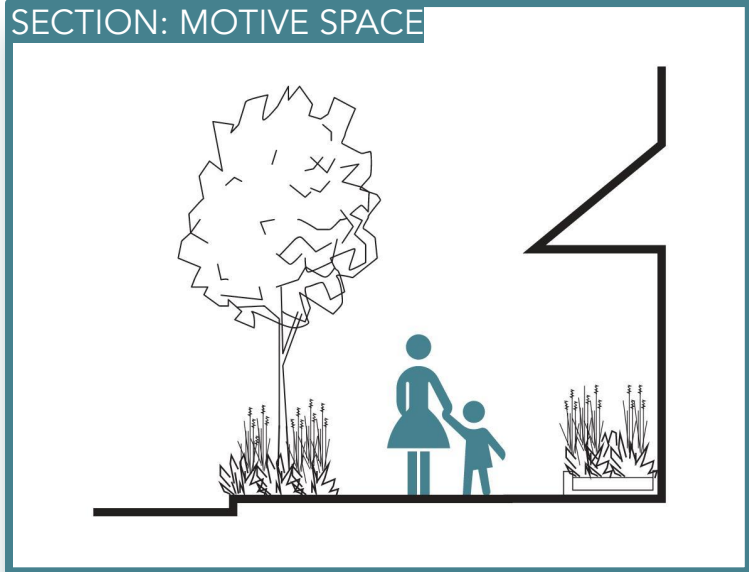

SECTION: COVERED GATHERING SPACE

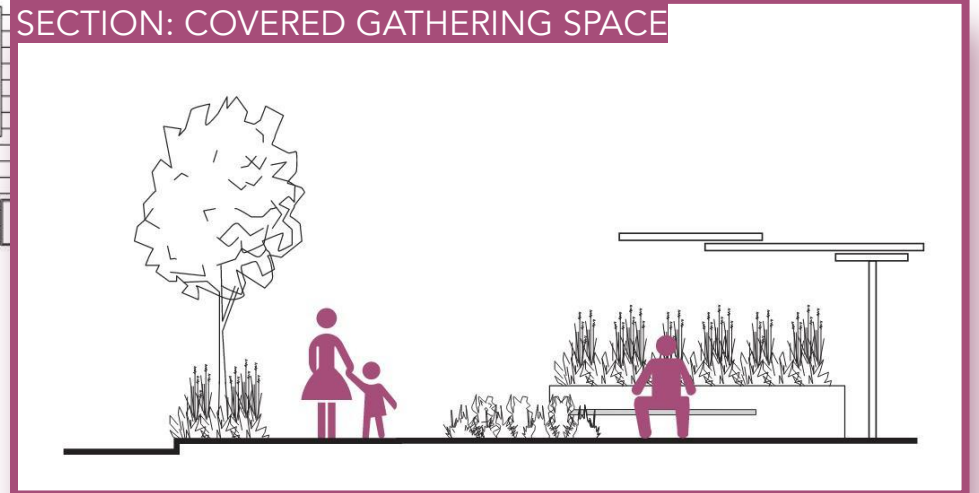

DESIGN CONCEPT: TECHNOLOGICAL INNOVATION

MODULARITY - SIMPLICITY - CONTRAST

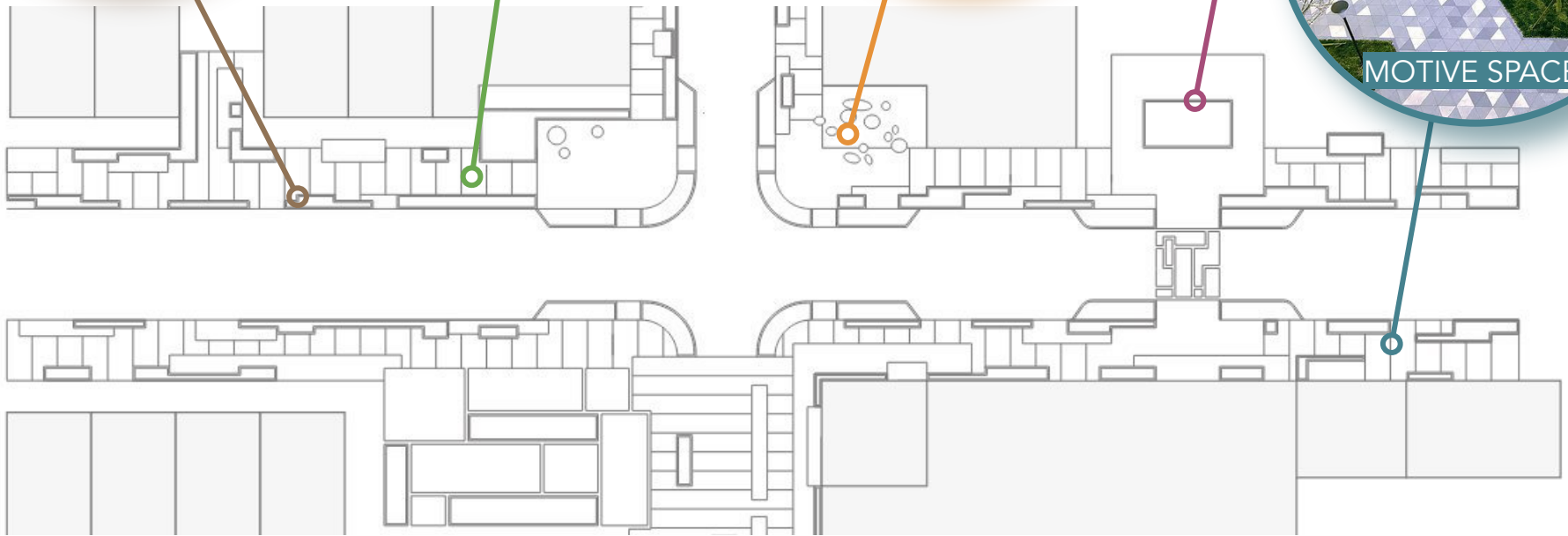

MATERIALS: TECHNOLOGICAL INNOVATION

MODULARITY - SIMPLICITY - CONTRAST

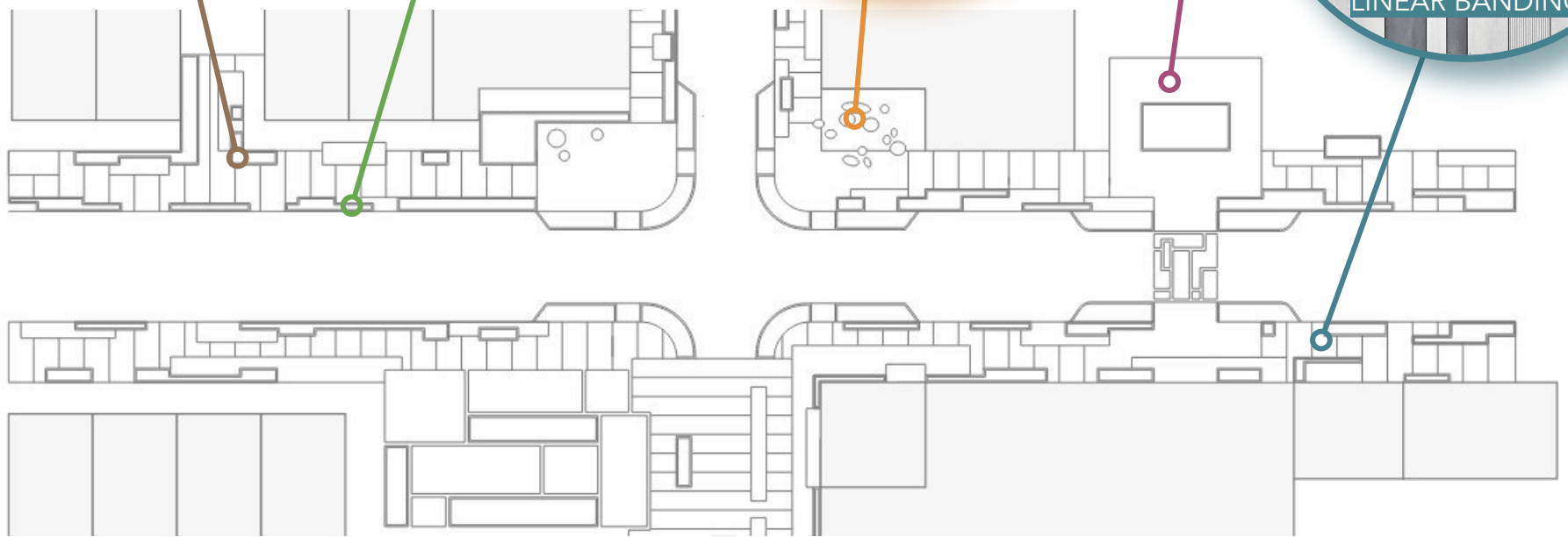

INTERSECTION DESIGN: TECHNOLOGICAL INNOVATION

MODULARITY - SIMPLICITY - CONTRAST

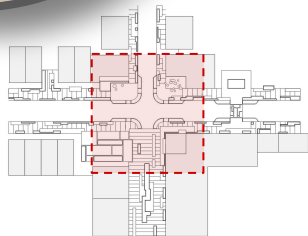

DESIGN CONCEPT: RIVER ENVIRONMENT

NATURAL - FLUIDITY - ORGANIC

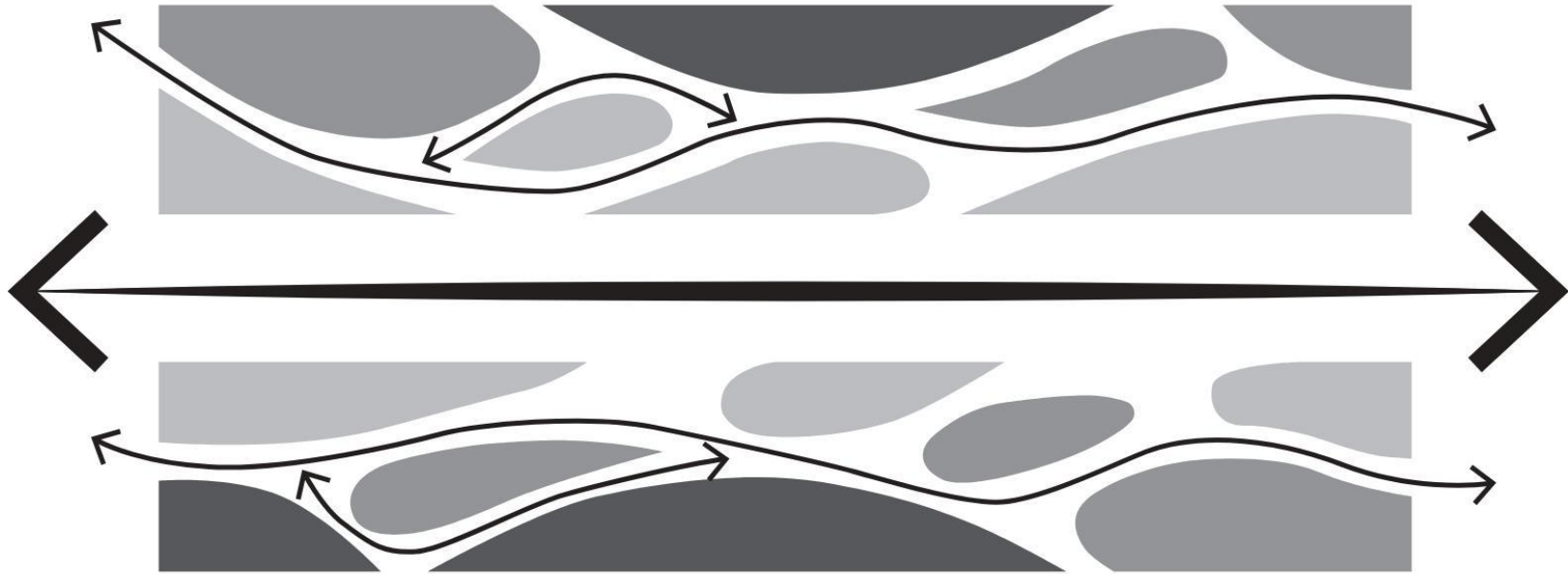

***Concept diagrams are not intended to show an actual to-scale design. Instead, this is an abstract depiction of how streetscape elements can be arranged with arrows representing movement through space, and colored blocks represent street elements.*

DESIGN CONCEPT: RIVER ENVIRONMENT

NATURAL - FLUIDITY - ORGANIC

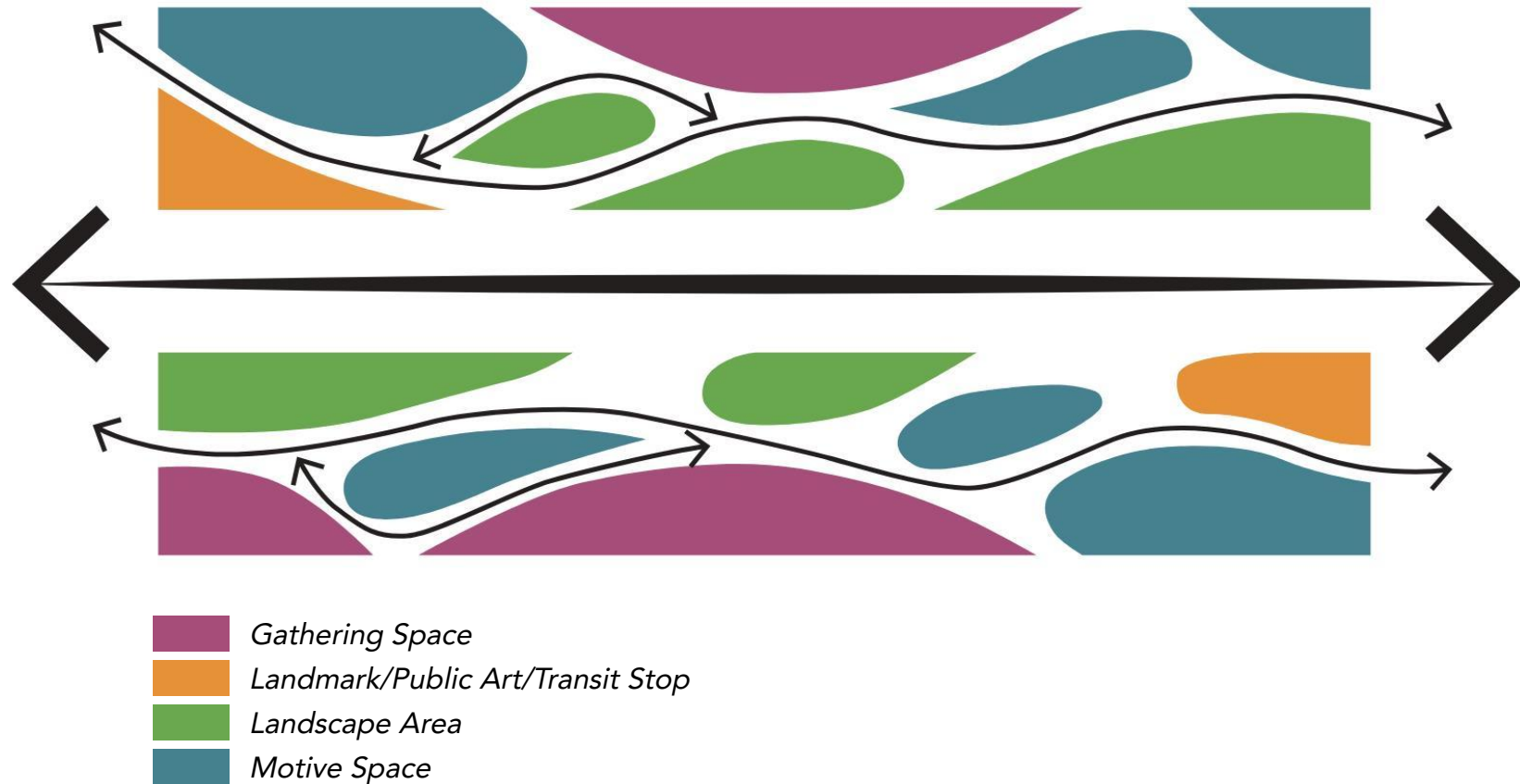

***Concept diagrams are not intended to show an actual to-scale design. Instead, this is an abstract depiction of how streetscape elements can be arranged with arrows representing movement through space, and colored blocks represent street elements.*

DESIGN CONCEPT: RIVER ENVIRONMENT

NATURAL - FLUIDITY - ORGANIC

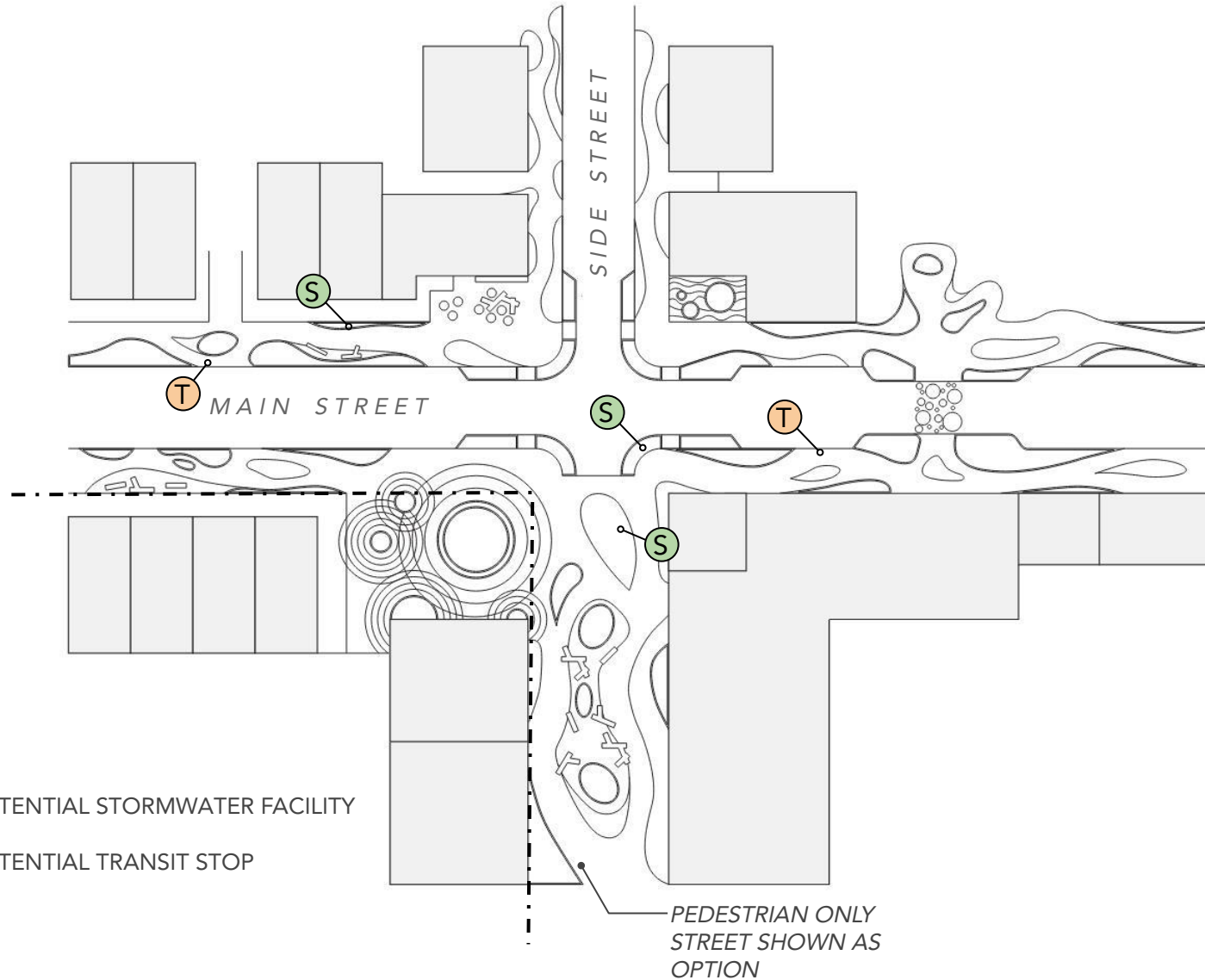

DESIGN CONCEPT: RIVER ENVIRONMENT

NATURAL - FLUIDITY - ORGANIC

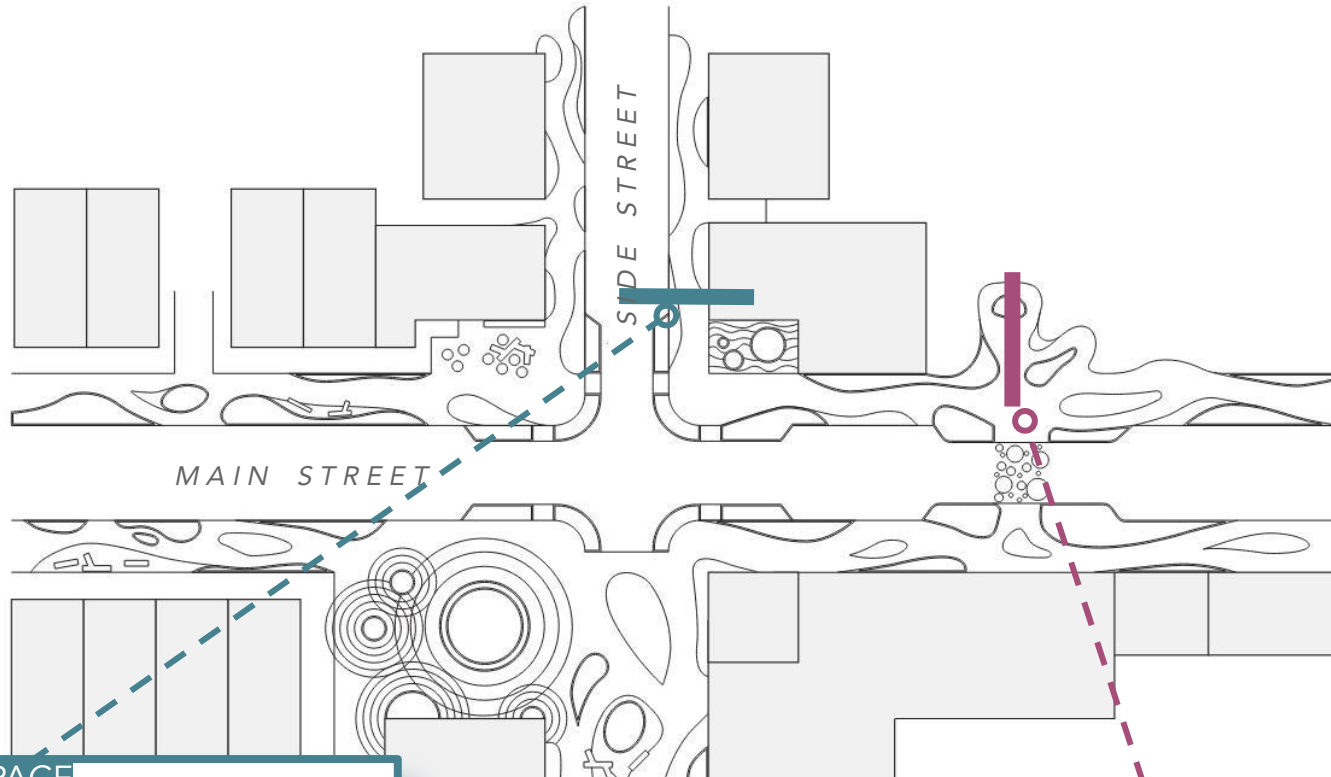

SECTION: MOTIVE SPACE



SECTION: COVERED GATHERING SPACE

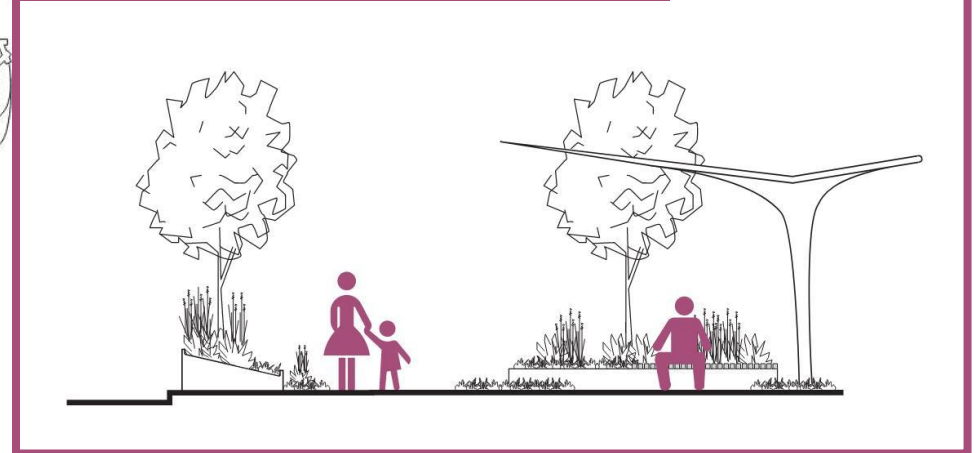

DESIGN CONCEPT: RIVER ENVIRONMENT

NATURAL - FLUIDITY - ORGANIC

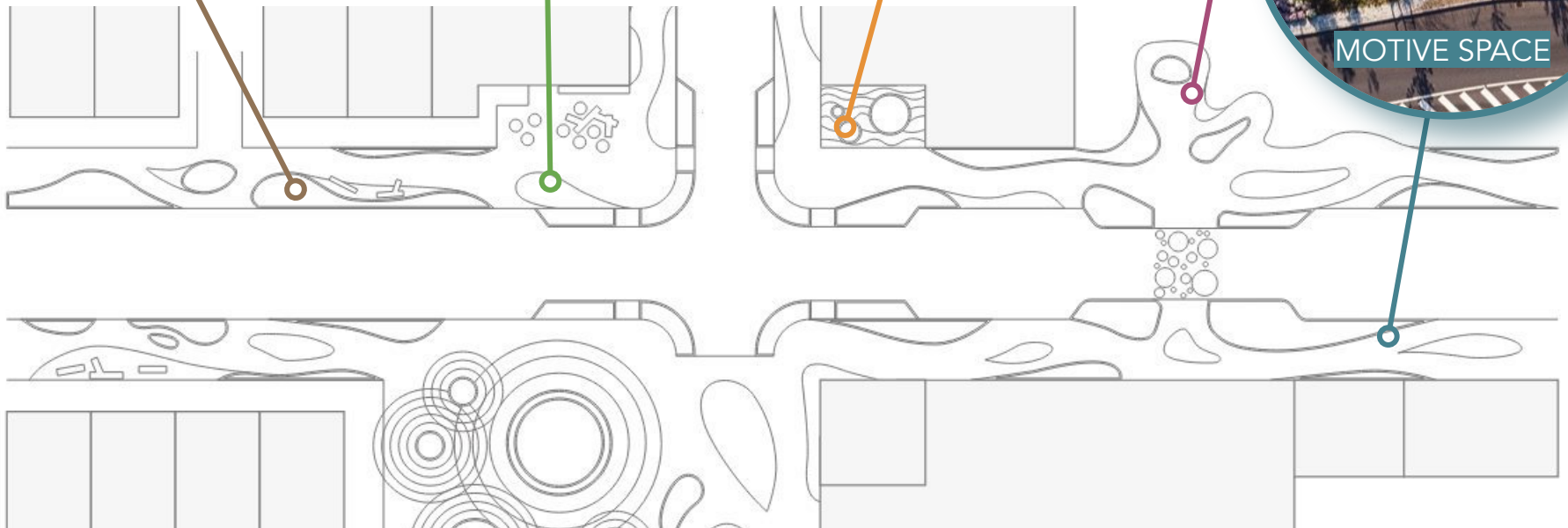

MATERIALS: RIVER ENVIRONMENT

NATURAL - FLUIDITY - ORGANIC

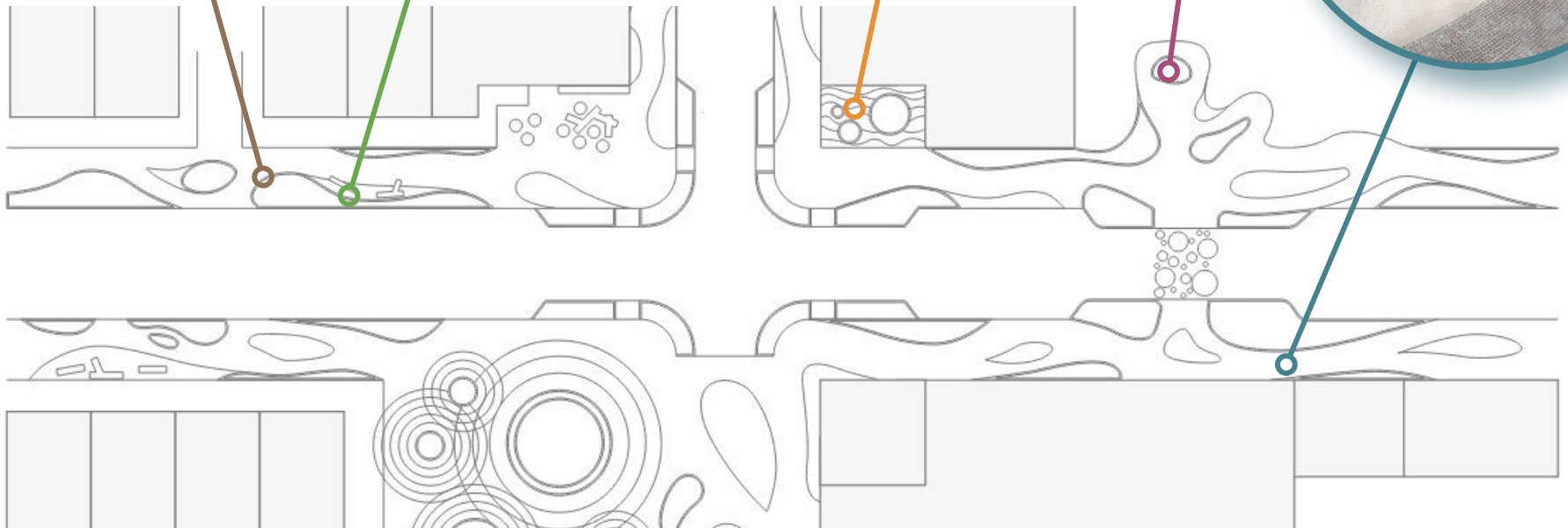

INTERSECTION DESIGN: RIVER ENVIRONMENT

NATURAL - FLUIDITY - ORGANIC

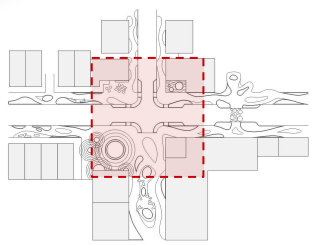



DESIGN CONCEPT COMPARISON

Concept 1: Agriculture

Concept 2: Technology

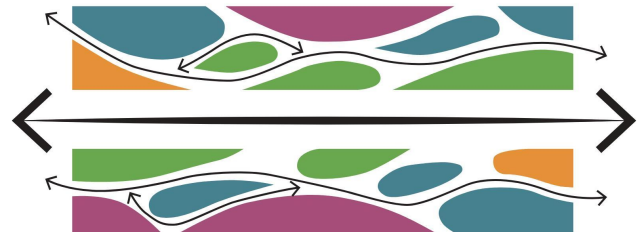
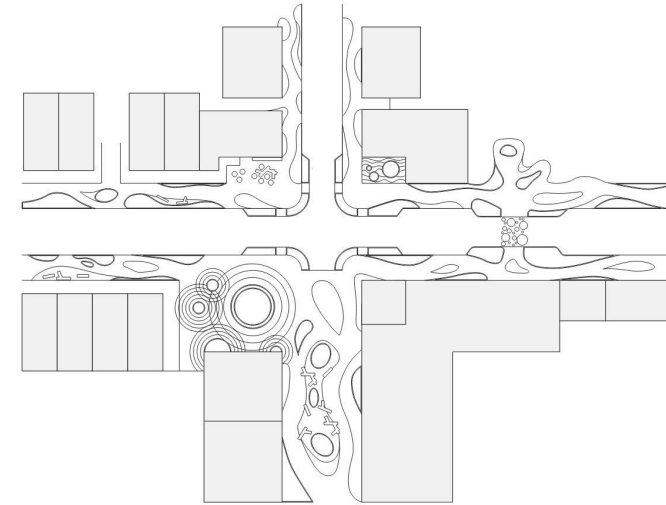
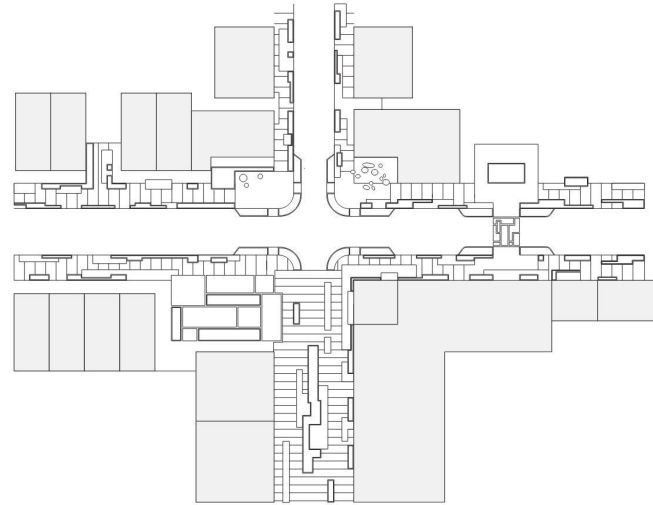
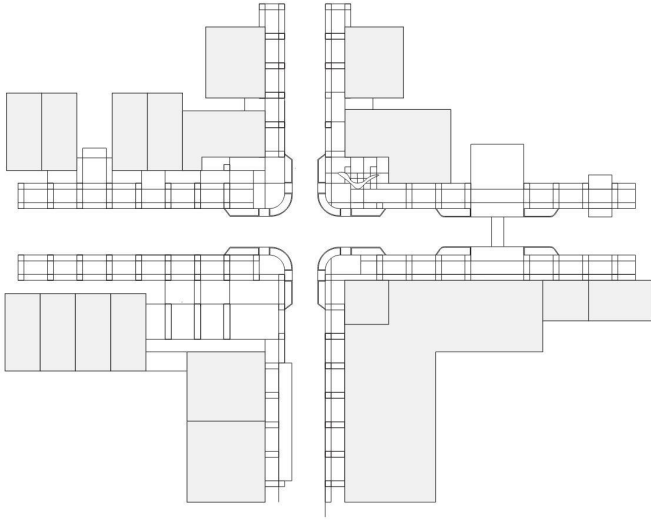
Concept 3: River



-  *Gathering Space*
-  *Landmark/Public Art/Transit Stop*
-  *Landscape Area*
-  *Motive Space*

appendix B: public engagement summary

INTRODUCTION

One of the implementation items included in the Town Center Master Plan calls for developing a Streetscape Plan. The Town Center Master Plan project launched in 2016 and concluded in 2019, with a robust public engagement process that resulted in detailed feedback from the community and other stakeholders. Additionally, the Citywide Signage and Wayfinding Plan and I-5 Pedestrian Bridge Project public engagement efforts further identified design preferences valued by residents and stakeholders in Wilsonville. This allowed the Town Center Streetscape project team to begin with a palette of materials and general design concepts using the community preferences identified by previous community engagement efforts. The feedback indicated a strong preference for modern designs with natural materials such as stone, wood, brick, and glass. Based on this information, the project team utilized these materials to prepare three initial design concepts.

COVID-19

When staff began the initial preparations to initiate the Town Center Streetscape project planning effort in late 2019 and early 2020, we envisioned holding open houses, engaging with students and seniors in person, and participating in City events to conduct public engagement for the project similar to what was done with the Town Center Master Plan. On March 11, 2020, the World Health Organization (WHO) declared the Covid-19 outbreak a pandemic. Governor Kate Brown issued a statewide stay-at-home order on March 23, 2020. As the pandemic evolved, the planning staff, which normally conducts public engagement in person, had think creatively about how to interact with the public in the midst of a pandemic and ever changing restrictions. The project scope accounted for remote public engagement activities and as a result, the project has conducted all public engagement efforts remotely. Remote public engagement allowed greater access to interested parties for providing input to the project, as people could participate in a variety of meeting times. However, the project team anticipated up to three stakeholder interviews to discuss the streetscape in depth and only two were conducted as it was prove challenging to contact various entities especially in commercial real estate as the pandemic most severely impacted the retail and restaurant industries.

PUBLIC FORUM 1

The first community engagement event for the Town Center Streetscape Plan was held on November 10, 2020. The project team held two sessions via Zoom from 12 PM – 1 PM and from 6 PM – 7 PM. The first forum provided an opportunity for attendees to learn more about the project ask questions and provide input on important streetscape elements to consider in developing the plan. The three initial concepts were introduced during the first public forum and the public was asked to provide their general feedback on the three so that the project team could refine them further for presentation at the second set of Public Forums. Between Forum 1 and Forum 2 the project went before Planning Commission and City Council for additional input and direction that further shaped the direction of the design concepts.

PUBLIC FORUM 2

The second community engagement event for the Town Center Streetscape plan was held on February 9, 2021. The project team once again held two sessions via Zoom from 12 PM – 1 PM and from 6 PM – 7 PM. The second public forum provided specific materials that would be proposed for each of the three design concepts, and provided a street cross-section to show how the streetscape would take shape in the context of each theme. The second public forum showed participants specific materials that would potentially be selected for each theme. An illustrative street intersection for each of the three concepts was shown to demonstrate how each of the themes could manifest in Town Center in the future. The project team took quick polls within the Zoom meeting and held a discussion to gauge participants preference for each of the three concepts. The project team conducted a corresponding survey on *Let's Talk, Wilsonville!* which is further discussed below.

LET'S TALK WILSONVILLE SURVEYS

The Town Center Streetscape Project Team conducted two public engagement activities utilizing the Let's Talk Wilsonville! The first engagement activity utilized the Ideas feature and participants were asked the following question: Are there streetscape designs in other places that you like and want us to consider for Town Center? To respond participants were able to provide free form responses and add pictures regarding what they would like to see in the future streetscapes in Town Center. This engagement activity corresponded to Forum 1 to broaden the reach for community engagement and gather additional preferences on the preliminary design phase of the project.

The second survey corresponded to Public Forum 2 and similar questions were posed to participants to gather input on the refined concept designs for each of the three concepts. The combined feedback from Public Forum 2 and the online survey component on Let's Talk Wilsonville indicated a strong preference toward the River Environment theme; however, discussion within the Public Forum and in the freeform response as part of the survey provided a strong rationale for incorporating elements of the Technological Innovation concept.

STAKEHOLDER INTERVIEWS

The project team held two stakeholder interviews to explore various topics related to the streetscape plan in depth with stakeholders who could provide detailed industry specific feedback. As the community has identified environmental stewardship and natural features as an important subject, the project team sought out a stakeholder interview with someone who had a similar interest in enhancing the urban tree canopy. A stakeholder interview with PlanITGeo, the consultancy working on the City's Urban Forestry Management Plan, was held on January 18, 2021. The interview sought to obtain recommendations on future street trees and trees within Town Center that may be worthy of preserving as future development occurs. This project coordination will lay the groundwork for matching recommendations for future street trees that are well suited for urban conditions, and identify other areas where the two projects can collaborate to create a healthy urban forest canopy as Town Center develops.

STAKEHOLDER INTERVIEWS CONT.

One topic mentioned multiple times during the Public Forums and initial Planning Commission and City Council Work Sessions was cost effectiveness and feasibility of the streetscape design and materials. As a result, the project team thought it would be essential to speak to a landowner or developer in Town Center to discuss long-term maintenance responsibilities and streetscape related elements tenants and employees seek out when leasing or developing land. The project team spoke with Susan Meyers of Capital Realty on March 2, 2021. Susan has been involved in Town Center for many years and developed numerous properties within Town Center. During this stakeholder interview a variety of plant materials and landscape designs were discussed that required additional maintenance that the project team will seek to avoid. It was also noted that prospective tenants are emphasizing walkability and bike friendliness as people want to be able to walk to lunch or coffee from their office. Tenants and employees also preferred clear visibility and sightlines when walking in an urban environment. The project team was able to incorporate this valuable insider feedback into landscape materials choices and choices were made to focus on more linear pathway systems in the Streetscape Plan.

OUTCOME

Despite the inherent challenges faced when conducting public engagement during a pandemic, the project was able to conduct a robust public engagement effort and obtain valuable feedback from the public. Throughout the planning process, the outreach and engagement activities solicited input and ideas from a broad range of community members and stakeholders including but not limited to: Wilsonville residents, youth and seniors, Spanish-speakers, service providers in Town Center, Town Center employees, Town Center residents, Town Center business and property owners and City staff.

OUTCOME CONT.

The public engagement effort began with the first Public Forum in November. There were two online public forums conducted on November 10, 2020, which introduced the project to participants. The afternoon session had ten participants and the evening session had five. The next two online public forums were conducted on February 9, 2021. The afternoon session had 12 participants and the evening session had 15. Participants of the public forums were asked four questions; the questions along with the responses provided by participants are shown below:

- Which of these concepts best reflects the goals of the Town Center Plan for: Design, Ecology, Safety and Comfort, Versatility, Sociability, Vibrant and Active?

Results: 13 River Environment, 7 Technological Innovation, 2 Agricultural Legacy

- Which elements (gathering space, movement areas, landscape, plazas, or public art) of the streetscape are most important to your enjoyment of a streetscape? Do you see those qualities in these concepts?

Results: 4 Movement Areas, 3 Plazas, 2 Landscape

- Please rank these concepts in order from favorite to least favorite

Results: 1st Place – 9 River Environment, 2 Technological Innovation, 0 Agricultural Legacy

2nd Place – 1 River Environment, 5 Technological Innovation, 5 Agricultural Legacy

3rd Place – 0 River Environment, 4 Technological Innovation, 6 Agricultural Legacy

- Open Response: Things you like or don't, Ways the concepts could blend together, Anything we haven't shown, Ways you could see yourself and the people you know using these streets?

OUTCOME CONT.

As a result of the second forum the following themes emerged:

- Construction costs and long term maintenance cost concerns
- Importance of lighting for safety and 24/7 usability of Town Center
- Concern about impact to existing businesses
- Movement areas (motive space) should be most prioritized
- Ensure design speeds of future Town Center streets are low to ensure safety
- Integrate public art into streetscape pavement or plaza / gathering spaces
- Incorporate art from young residents as seen in the Wilsonville Road / I-5 Interchange
- Include spaces for tactical urbanism (Tactical urbanism refers to low-cost, short-term changes to the built environment with the intent of catalyzing long-term change. Citizens, organizations, or local governments most commonly initiate tactical urbanism efforts.)
- Incorporate public art that reflects multi-ethnic backgrounds of residents
- Provide ADA plates that are tactile and highly visible
- River Environment concept is strong but may be excessive for the large scale of Town Center
- Movement areas should be direct and less meandering even if other components are curvilinear due to accessibility concerns
- Interest in a design that will age well

OUTCOME CONT.

Within the online components of the public engagement effort held on *Let's Talk, Wilsonville!* utilizing the ideas feature where the public can provide free form narrative responses asked interested parties the following question:

- Are there streetscape designs in other places that you like and want us to consider for Town Center?

We received two responses before the portal closed, the two participants noted streetscapes with separation or buffer strips containing trees and landscaping between the road and pedestrians, and ample room for outdoor dining.

The Streetscape Concepts Survey was posted on February 18, 2021 and closed on February 26, 2021. There were 67 participants that responded to the survey providing the bulk of the community engagement input for the project. Participants were asked four questions:

1. Which streetscape concept contains the materials you would most like to see in future Town Center streetscapes?
2. Which elements (gathering space, movement areas, landscape, plazas, or public art) of the streetscape are most important to your enjoyment of a streetscape?
3. Please rank the three streetscape concepts in order of preference:
4. Provide any additional feedback you have for the project team, such as: likes / dislikes, additional elements to incorporate, how you see yourself using these streetscapes, ways the concepts could be blended together.

OUTCOME CONT.

The results indicated that 61% of participants preferred the materials shown in the River Environment concept with materials shown for Technological Innovation in second place with 25%.

Of the elements listed, participants ranked Landscaped Areas highest, with Gatherings Spaces, Motive Space (Sidewalks and Pathways), and Public Art and Public Plazas last.

The ranking of the concepts provided similar results as the material preference with River Environment 1st, Technological Innovation 2nd, and Agricultural Legacy in 3rd place.

The free form responses for question 4 emphasized landscaping and trees, and curvilinear lines. Several comments emphasized clear linear movement and connections through Town Center, which led the team to incorporate elements from the Technological Innovation concept into the final design.

Overall, the feedback and discussions that stemmed from the public engagement efforts reflect the priorities and values noted by the community in past Town Center related planning efforts. The input received during the Town Center Streetscape Community engagement process informed various design decisions included in the Streetscape Plan.

***appendix C: transportation system plan 2020
update summary***

TRANSPORTATION SYSTEM PLAN - 2020 UPDATE

The Wilsonville Transportation System Plan (TSP) is the City's long-term transportation plan and is an element of its Comprehensive Plan. It includes policies, projects, and programs that could be implemented through the City's Capital Improvement Plan, development requirements, or grant funding.

The two images here describe the Functional Classification (left image) and Bikeway Classification (right image) applied to certain Town Center streets. The project list for the Town Center is provided on the following pages.

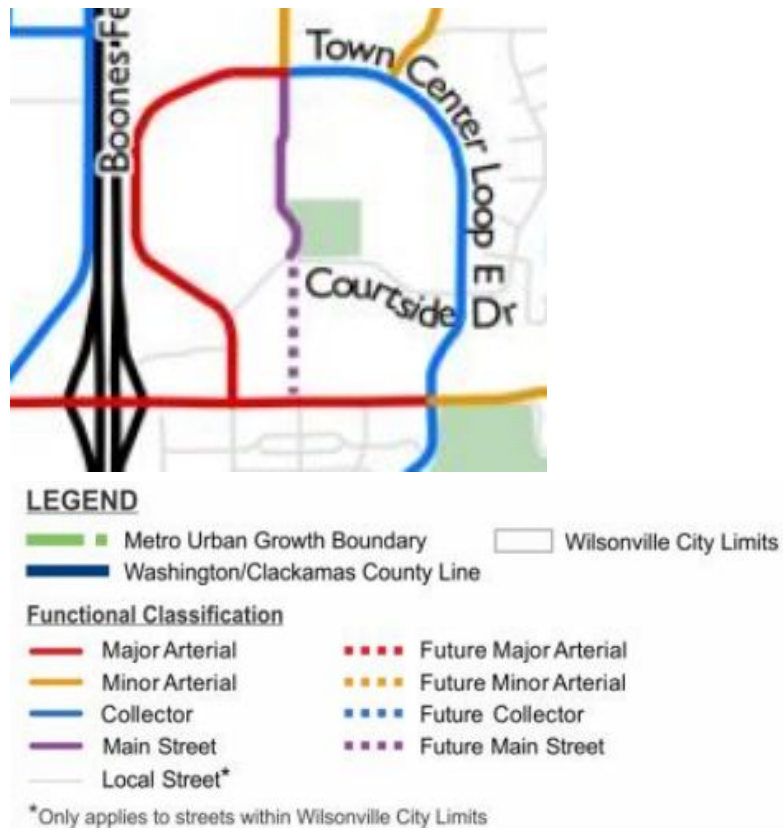

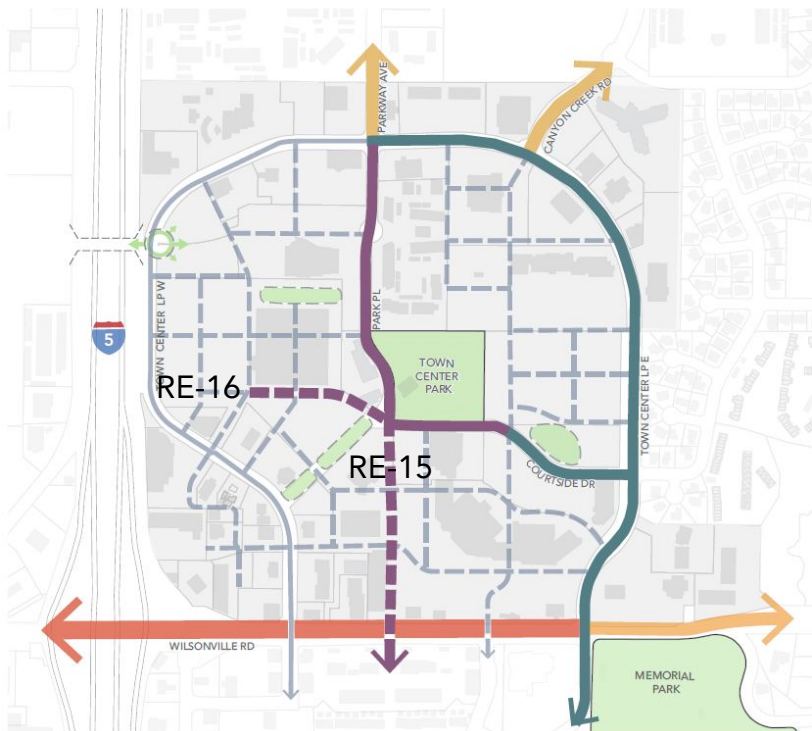

Project	Description	Cost
Roadway Extensions		
RE-15 Park Place Extension	Construct an extension of Park Place from Courtside Drive to Wilsonville Road as a new main street with two travel lanes, parking, and sidewalks on both sides (see Figure 3- 13). This extension will create a new signalized intersection at Wilsonville Road (SI-10).	\$6,300,000
RE-16 Courtside Drive Extension	Construct an extension of Courtside Drive from Park Place to Town Center Loop West as a new main street with two travel lanes, buffered bike lanes, and sidewalks (see Figure 3-13).	\$6,600,000

PLANNING CONTEXT

TRANSPORTATION SYSTEM PLAN - 2020 UPDATE

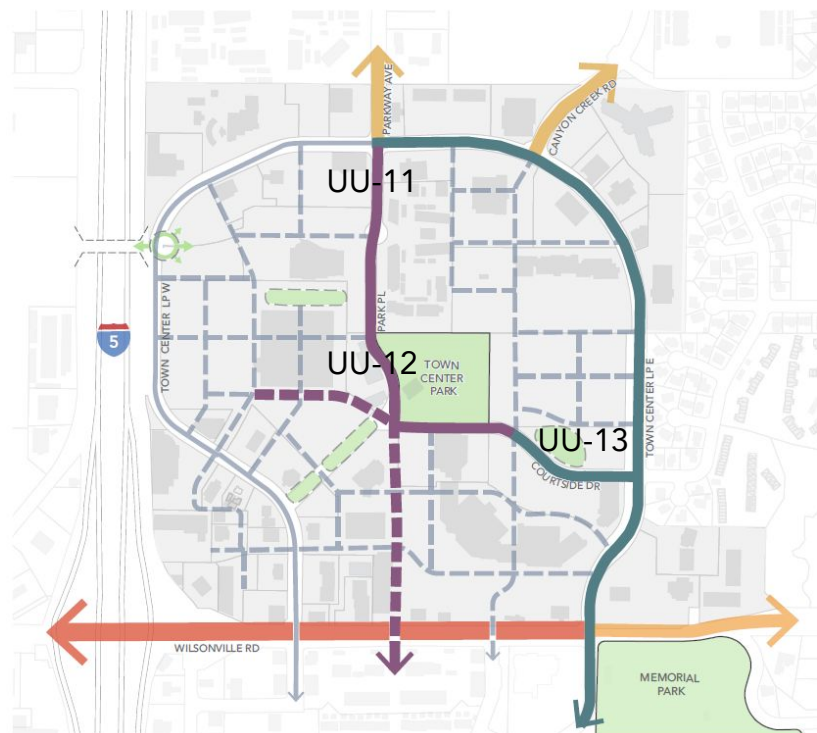

Project	Description	Cost
Urban Upgrades		
UU-11 Park Place Redesign	Upgrade Park Place between Town Center Loop and northern edge of Town Center Park to meet the cross-section standard in Figure 3-13, which includes two-travel lanes with buffered bike lanes and sidewalks.	\$4,400,000
UU-12 Park Place at Town Center Park Redesign	Upgrade Park Place between the northern edge of Town Center Park to Courtside Drive to meet the cross-section standard in Figure 3-13, which includes the installation of two-lane curb-less street with on street parking, a two-way buffered cycle track, and sidewalks.	\$3,700,000
UU-13 Courtside Drive Updates	Upgrade Courtside Drive between Town Center Loop East and Park Place to meet the cross-section standard in Figure 3-13, which includes the addition of a buffered two-way cycle track and parking on the south side of Courtside Drive.	\$7,900,000

PLANNING CONTEXT

TRANSPORTATION SYSTEM PLAN - 2020 UPDATE



Project	Description	Cost
Spot Improvements		
SI-09 Wilsonville Road/ Town Center Loop West Turn Lane Removal	Modify the existing signal to eliminate eastbound and westbound left turns, add a landscaped median to the west leg, and add a crosswalk to the west side of the intersection with a median refuge island. This project should include a "trap lane" to mitigate queuing into the ramp terminal intersection unless at the time of construction a 20-year analysis demonstrates that it is not needed or if alternative mitigation is identified that that has similar or better results.	\$750,000
SI-10 Wilsonville Road/Park Place New Traffic Signal	Modify the intersection to add left turn lanes on Wilsonville Road and install a traffic signal that allows all turning movements. To be installed in conjunction with SI-09 and RE-15. The project should include signal coordination with dump loop sensors unless at the time of construction a 20-year analysis demonstrates that the sensors and signal coordination in the corridor is not needed or if alternative mitigation is identified that that has similar or better results. Both projects SI-09 and SI-10 should be implemented simultaneously.	\$1,500,000
SI-11 Wilsonville Road/ Town Center Loop East Dual Left Turn Lanes	Modify the existing traffic signal to include dual eastbound left turn lanes and modify the north leg to have dual receiving lanes. Removed eastbound and southbound dedicated right turn lanes to accommodate added lanes. Coordinate the signal modifications to accommodate project BW-19b (see next page).	\$1,500,000

PLANNING CONTEXT

TRANSPORTATION SYSTEM PLAN - 2020 UPDATE

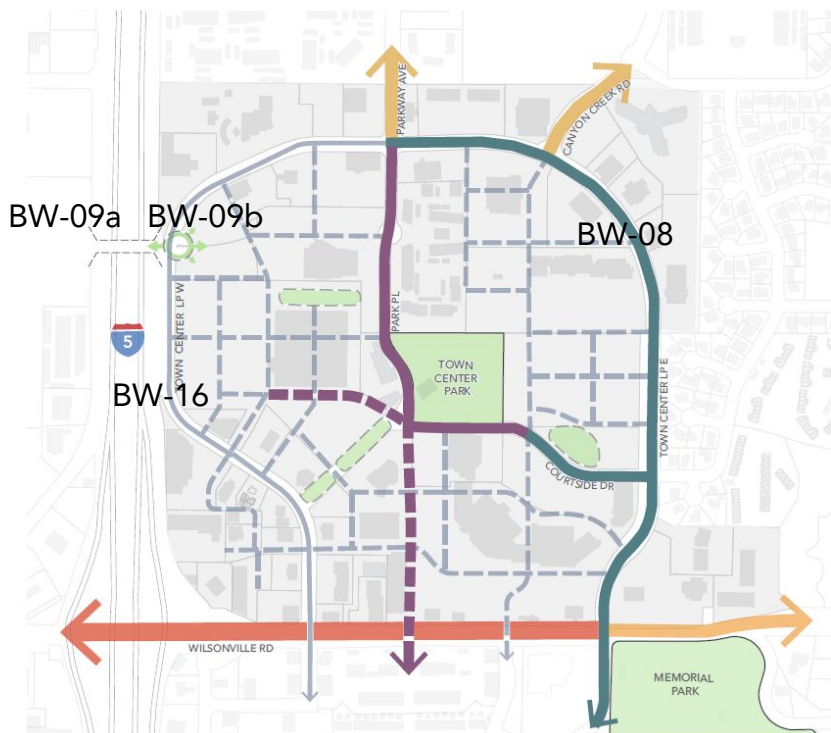

Project	Description	Cost
Standalone Pedestrian and Bicycle Improvements (Bikeways and Walkways)		
BW-08 Town Center Loop Pedestrian, Bicycle, and Transit Improvements	Create more direct connections between destinations within Town Center area, improve accessibility to civic uses and transit stops, retrofit sidewalks with curb ramps, highlight crosswalks with colored pavement, and construct other similar treatments that support pedestrian, bicycle, and transit access and circulation; also construct shared-use path along Town Center Loop West from Wilsonville Road to Parkway Avenue.	\$500,000
BW-09a I-5 Bike/Pedestrian Bridge	Construct Bike/Pedestrian Bridge over I-5 approximately aligned with Barber Street to improve connectivity of Town Center area with businesses and neighborhoods on west side of I-5; include aesthetic design treatments.	\$4,000,000
BW-09b I-5 Bike/Pedestrian Bridge Gateway Treatments	Install architectural elements, seating, landscaping, and wayfinding/directional signage at the gateway of the I-5 Pedestrian/Bicycle bridge.	\$1,500,000
BW-16 Town Center Loop Bike Lanes	Reduce the number of travel lanes on Town Center Loop West between Parkway Avenue and Wilsonville Road to three lanes and restripe the outside lanes for bicycle lanes.	\$207,000

appendix D: signage and wayfinding plan summary

PLANNING CONTEXT

CITYWIDE SIGNAGE AND WAYFINDING PLAN - 2018

The Signage and Wayfinding Plan contains recommendations for the Town Center's streets and public spaces. The navigation and place markers will support people travelling by all modes and for various reasons to more easily orient themselves in the Town Center and make their way to destinations. Signage made of metal, stone, and other natural materials will be installed along Parkway Avenue and Town Center Loop in upcoming phases (Implementation Phases below). The Sign Type figure describes the location of future signage installations, and a sample of each sign type is shown at right.

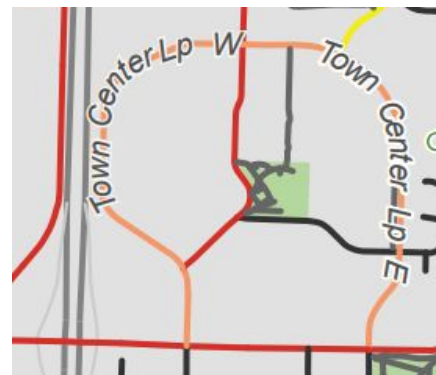

IMPLEMENTATION PHASES

- PHASE ONE
- PHASE TWO
- PHASE THREE

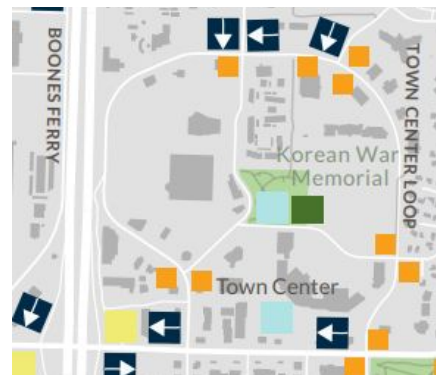

SIGN TYPES

- VEHICULAR SIGN
- PARK SIGN (LARGE OR SMALL)
- WELCOME SIGN
- GATEWAY SIGN
- KIOSK
- PEDESTRIAN SIGN

APPENDIX D: SIGNAGE AND WAYFINDING PLAN

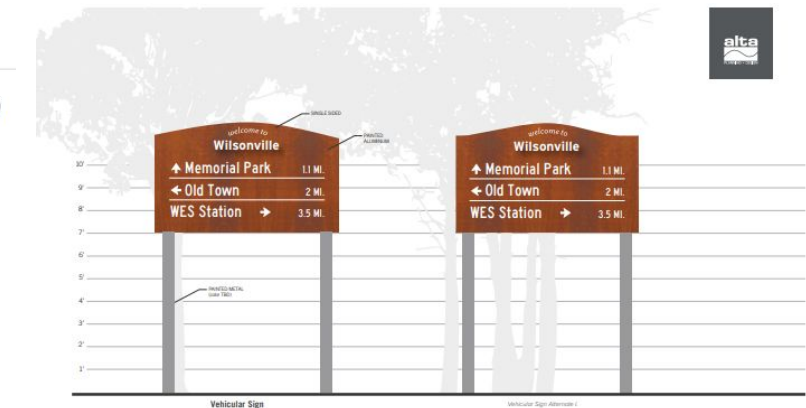
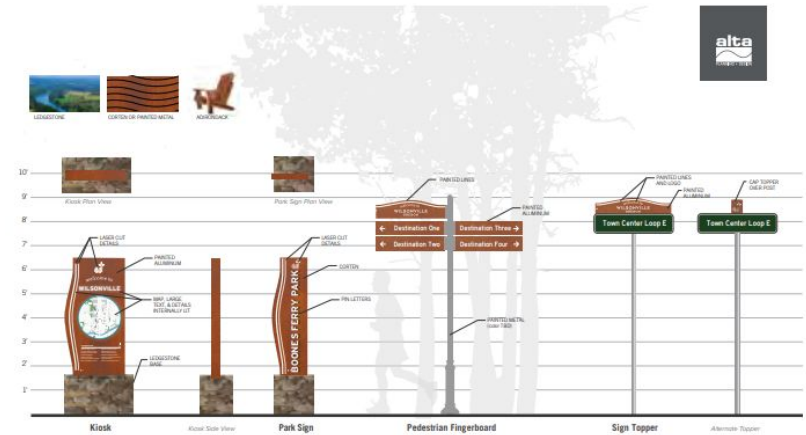

appendix E: product and material specification sheets

La Pietra
MODERNA



La Pietra™ Moderna Umbria Blend

La Pietra™ Moderna

Our textured surface La Pietra™ family of slabs have been a popular stone for us since its release in 2015. This year, we're releasing a new, additional surface finish for the La Pietra™ family, the flat-topped, beveled edge La Pietra™ Moderna.

La Pietra™ Moderna's smooth finish pairs well with our other smooth stones such as Holland or our Leiden collection. Like these other stones, La Pietra™ Moderna also has a bevel on the edge, but we've made it slightly wider to balance it with the larger size.

This five piece modern family of slabs is available now in Cambridge Blend, Jamestown Blend, and our brand new Umbria Blend.



Large Square
(sold individually)
530x530x60mm • 20.87x20.87x2.36"



Medium Square*
352x352x60mm • 13.86x13.86x2.36"



Large Rectangle*
530x352x60mm • 20.87x13.86x2.36"



Small Rec*
352x174x60mm • 13.86x6.85x2.36"



Small Square*
174x174x60mm • 6.85x6.85x2.36"



Cambridge Blend

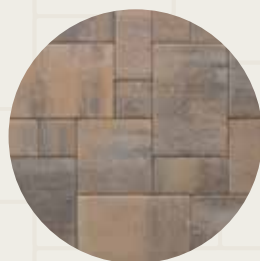

Jamestown Blend

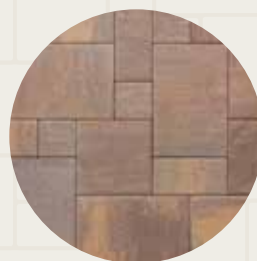

Umbria Blend

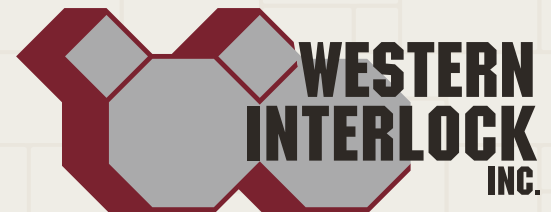

503.623.9084 | 360.878.9301
westerninterlock.com

The Concrete Advantage.



La Pietra™ Moderna Umbria Blend



La Pietra™ Moderna Cambridge Blend



La Pietra™ Moderna Jamestown Blend



La Pietra™ Moderna Umbria Blend

Generation 50

landscapeforms®

Product Data Sheet

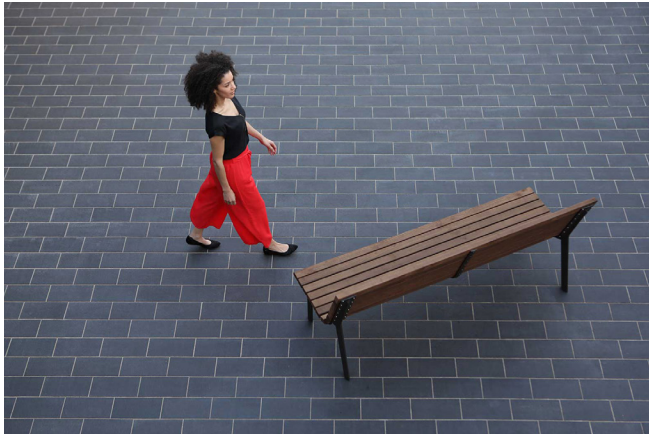

The Generation 50 line of benches and litter receptacles is a modern interpretation of several of the company's classic designs. "Generation 50 pays homage to the design, culture, and craft that is at the heart of the company but also takes advantage of the manufacturing expertise and new technologies that characterize Landscape Forms now and into the future," says Generation 50 designer Robert Chipman. Angular, diamond-shaped detailing is the shared visual character across the line's pieces. Generation 50's many options and broad application fit multiple site designs and uses. Benches can be specified with or without backs; in traditional, cantilevered, top-of-wall mounted, and wall mounted styles; with curved or straight face boards; and with three arm options or without arms. A litter receptacle in two styles rounds out the line. The elements are made of cast aluminum, steel, and wood, including thermally modified ash, a domestically sourced, sustainable material.

Bench

- Generation 50 benches are available backed or backless.
- The bench has aluminum casting supports with a powdercoat finish, and a wood seating surface.
- Bench is available in four different styles – traditional, cantilever, top of wall, and wall mount
- Generation 50 bench styles include a variety of mounting options:
 - Generation 50 traditional is available freestanding, surface mount, or embedded
 - Generation 50 cantilever is available embedded or surface mounted.
 - Generation 50 top of wall is available embedded or surface mounted.
 - Generation 50 wall mounting – hardware to anchor to wall not included.
- Benches are 72" in length
- The backed and backless benches are available with either no arms, end arms, or end and center arms.
- The backed bench is offered with two arm styles - angle or loop arms.
- The backless bench is only available with angle arms.
- Available in ipe, jarrah, and domestically sourced thermally modified ash (DSTMA) for exterior use.
- Available in jarrah, domestically sourced thermally modified ash (DSTMA), oak, and maple with LF-80 for interior use.
- The face boards of the bench can either be curved or straight-cut.
- Most styles of Generation 50 benches ship fully assembled.

	Style	Depth	Width / Length	Height	Weight
	Traditional Backless	23.5"	72"	17.25"	88 lbs
	Traditional Backless with (2) Arms	23.5"	72"	21.5"	95 lbs
	Traditional Backless with (3) Arms	23.5"	72"	21.5"	98 lbs
	Traditional Backed	26"	72"	33"	130 lbs
	Traditional Backed with (2) Arms	26"	72"	33"	139 lbs
	Traditional Backed with (3) Arms	26"	72"	33"	144 lbs

Note: Weights and dimensions based on jarrah wood (straight-cut faceboards) and angle arms

	Faceboard Style
	Straight Cut
	Curved



Generation 50

landscapeforms®

Product Data Sheet

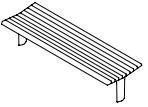
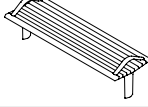
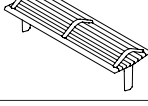
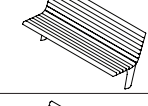
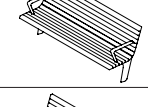
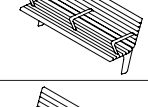
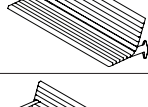
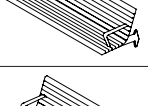
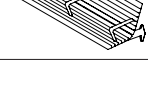

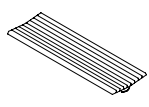
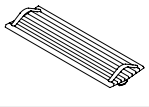
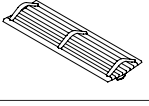
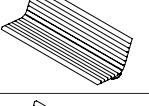
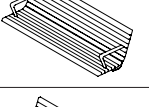
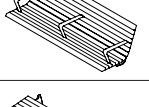
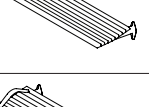
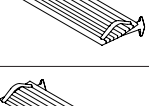
	Style	Depth	Width/Length	Height	Weight
	Cantilever Backless	23.5"	72"	17"	82 lbs
	Cantilever Backless with (2) arms	23.5"	72"	21.25"	89 lbs
	Cantilever Backless with (3) arms	23.5"	72"	21.25"	92 lbs
	Cantilever Backed	26"	72"	32.75"	127 lbs
	Cantilever Backed with (2) arms	26"	72"	32.75"	136 lbs
	Cantilever Backed with (3) arms	26"	72"	32.75"	140 lbs
	Wall Mount Backed	28.5"	72"	27"	133 lbs
	Wall Mount Backed with (2) arms	28.5"	72"	27"	141 lbs
	Wall Mount Backed with (3) arms	28.5"	72"	27"	146 lbs

	Style	Depth	Width/Length	Height	Weight
	Top of Wall Backless	23.5"	72"	6"	78 lbs
	Top of Wall Backless with (2) arms	23.5"	72"	10.25"	85 lbs
	Top of Wall Backless with (3) arms	23.5"	72"	10.25"	89 lbs
	Top of Wall Backed	26"	72"	21.5"	123 lbs
	Top of Wall Backed with (2) arms	26"	72"	21.5"	131 lbs
	Top of Wall Backed with (3) arms	26"	72"	21.5"	136 lbs
	Wall Mount Backless	28.5"	72"	11.5"	90 lbs
	Wall Mount Backless with (2) arms	28.5"	72"	15"	97 lbs
	Wall Mount Backless with (3) arms	28.5"	72"	15"	101 lbs



Note: Weights and dimensions based on jarrah wood (straight-cut faceboards) and angle arms

Generation 50

landscapeforms®

Product Data Sheet

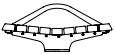

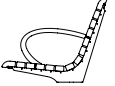
	Arm Styles
	Backless, Angle Arm
	Backed, Angle Arm
	Backed, Loop Arm

[Home \(/en\)](#)

[Products \(/en/products\)](#)

STREETLIFE®

[\(/en\)](#)

[Sustainability \(/en/sustainability-streetlife\)](#)

[nl \(/nl/producten\)](#) [Projects \(/en/projects\)](#) [us \(/en/news\)](#) [roughready-curved-benches](#)

[en \(/en/products/roughready-curved-benches\)](#) [fr \(/fr/produits/bancs-roughready-curved\)](#)

[de \(/de/produkte\)](#) [Company \(/en/company\)](#) [Downloads \(/en/downloads\)](#)

[Contact \(/en/contact\)](#)

Rough Benches & Picnic Sets

Rough&Ready Curved Benches

With their curved shape, Rough&Ready (R&R) Curved Benches have a distinctive appearance. These benches consist of transverse modular beams mounted in a self-supporting comb. The 200 cm-long modules can be linked together to create any desired length. Arm- and backrests are available as optional add-ons.

Backrests consist of a rounded back element that can be mounted almost anywhere on the bench. In addition to wood, the seat beams are also available in All Black plastic recyclate. Thanks to the orientation of the beams, the bench has a natural anti-skate protection.

Seat depth 40 cm – 16", minimum outer radius = 150 cm – 59"

Seat depth 50 cm – 20", minimum outer radius = 175 cm – 69"

Seat depth 60 cm – 24", minimum outer radius = 225 cm – 89"

Three types of backrests can be mounted on the R&R Curved Benches, both on the curved inside and on the outside.





Possibilities and restraints

- Standard seating depths are ca.40, 50 or 60 cm
- Available in different radii, depending on the seating depth
- Longer setups are possible with extension modules
- Optionally available are armrests or several types of backrests
- Optionally a LEDbox is available to house the drivers for LED lighting
- By default finished in galvanised steel (-TH), optionally steel parts in untreated weathering steel (-CT) or finished in a double layer powder coating (-PC)
- Also available in All Black composite material (-AB, max. beams length 250 cm)

REQUEST QUOTATION OR INFORMATION

([HTTPS://WWW.STREETLIFE.NL/EN/REQUEST-QUOTATION](https://www.streetlife.nl/en/request-quotation))



(<https://www.streetlife.nl/sites/default/files/afbeeldingen/producten/Default>)



(<https://www.streetlife.nl/sites/default/files/afbeeldingen/producten/Default>)



FSC Hardwood I
- Virgin

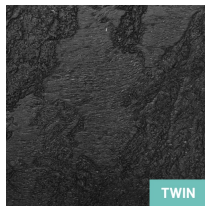

All Black -
Recycled



Accoya Wood -
Virgin

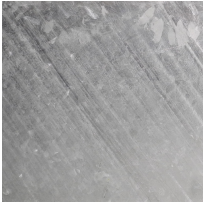

Galvanised Steel

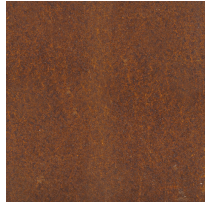

CorTen Steel



Powder Coating

Related products

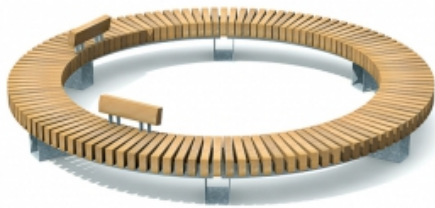

Rough&Ready Circular Benches

(<https://www.streetlife.nl/en/products/roughready-circular-benches>)



Rough&Ready Crosswise Benches

(<https://www.streetlife.nl/en/products/roughready-crosswise-benches>)



Rough Benches & Picnic Sets

Rough&Ready Accessories

The new USB Power Charger is ideal for use on university or corporate campuses, in shopping areas or near bus and train stations. The stainless steel module is placed on the end of a 7x15cm - 2.8"x5.9" Rough&Ready (R&R) beam.

The classic Armrest is a sleek bracket that is easy to mount on the bench. The Armrest is available in several steel versions, each with its own appearance.

The stainless steel R&R Wide Armrest encloses the seat at both ends of a beam and has the same width as the transverse beams. As a result, the Wide Armrest appears to be an integral part of the bench.

Various types of horizontal backrests are available for R&R Curved, Crosswise and Linear Benches. The backrests comprise stainless steel brackets in combination with wooden or All Black beams. The length of a standard backrest varies per

bench type.

The Royal Back is a high backrest with vertical beams that are flush with the seat. The length of the backrest is preferably the same as that of a seating segment but can also be extended to become a continuous backrest.





Possibilities and restraints

- The USB Power Charger can be used across the entire R&R Range. The Charger has an IP67 protection rating (immersion-proof), a standby function and is IEC (CB) and EMC certified to guarantee safe use outdoors
- The Classic Armrest is available in powder coating, Two Tone CorTen coating and glass-bead blasted stainless steel
- The Wide Armrest can be used on R&R Curved and Crosswise models with seat depths of 40, 50 and 60cm - 16", 20" and 24"
- The R&R Royal Back can be used on R&R Circular, Crosswise and Curved Benches

REQUEST QUOTATION OR INFORMATION

([HTTPS://WWW.STREETLIFE.NL/EN/REQUEST-QUOTATION](https://www.streetlife.nl/en/request-quotation))



(<https://www.streetlife.nl/sites/default/files/afbeeldingen/producten/Default>)



(<https://www.streetlife.nl/sites/default/files/afbeeldingen/producten/Default>)



FSC Hardwood I
- Virgin

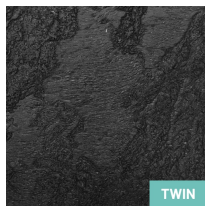

All Black -
Recycled

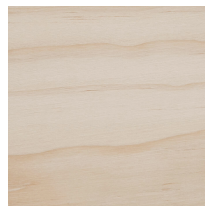

Accoya Wood -
Virgin

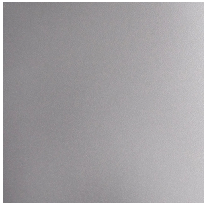

Stainless Steel

Related products

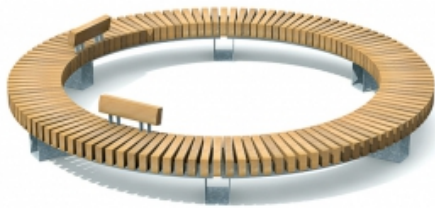

Rough&Ready Circular Benches

(<https://www.streetlife.nl/en/products/roughready-circular-benches>)

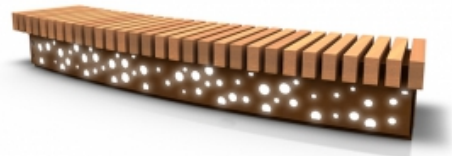

Rough&Ready Seat Wall

(<https://www.streetlife.nl/en/products/roughready-seat-wall>)



Green Benches, Tree Isles & Podiums

Rough&Ready Free Form Tree Isles

Many shapes can be created with the Rough&Ready (R&R) Free Form Tree Isles system. In order to integrate a R&R Crosswise seat, a diameter of at least three metres is required. The border seats are made from FSC hardwood or All Black beams comprising 100% recycled plastic (PE and PP).

These images illustrate various options using Streetlife's Tree and Seating Isles in a variety of shapes and designs. Larger trees can be securely anchored using a special-purpose sub-soil support system and illuminated using recessed Tree Air® spotlights.

In the R&R Free Form Tree Isles Italic, the walls of the isles are placed at an angle, which provides more legroom but above all creates a dynamic appearance. The Italic walls can be used in all Tree Isle designs with R&R Crosswise seats.

Products supplied within the North American market are fully manufactured in the USA.





Possibilities and restraints

- This product is the most efficient in lengths that are a multiple of ca.300 cm | 118"
- On request the main dimensions of this product can be customized
- The standard material is untreated weathering steel (-CT), optionally at a surcharge finished in a double layer powder coating (-PC)

REQUEST QUOTATION OR INFORMATION

([HTTPS://WWW.STREETLIFE.NL/US/REQUEST-QUOTATION](https://www.streetlife.nl/us/request-quotation))



(https://www.streetlife.nl/sites/default/files/afbeeldingen/producten/07car_FV.jpg)



(<https://www.streetlife.nl/sites/default>)



(https://www.streetlife.nl/sites/default/files/afbeeldingen/producten/07car_F)



FSC Hardwood I
- Virgin

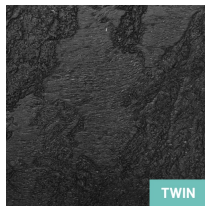

All Black -
Recycled

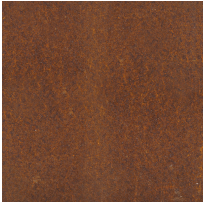

CorTen Steel



Powder Coating

Related products



Mobile Green Isles

(<https://www.streetlife.nl/us/products/mobile-green-isles>)

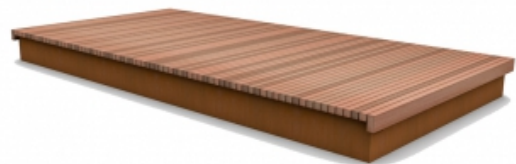

Solid Podium Isles ([https://www.streetlife.nl/us/products/solid-](https://www.streetlife.nl/us/products/solid-podium-isles)

[podium-isles](https://www.streetlife.nl/us/products/solid-podium-isles))



Rama Area Light

landscapeforms®

Product Data Sheet | RAL



Designed by Gonzalo Mila, Rama offers a minimalist design, universal aesthetic, and broad versatility. Directional lighting reduces light pollution and puts light where it is needed, and energy-efficient, warm white LEDs with a clear or frosted lens provide excellent performance and a great visual experience. Single or multiple luminaires that can be mounted in different positions on a range of pole heights make Rama suitable for any outdoor space. A simple clamping mechanism allows Rama luminaires to be retrofitted to existing 5" poles. With multiple distribution types and drive currents, Rama provides appropriate light levels for a variety of outdoor spaces and lighting requirements.

Housing & Materials

Cast aluminum construction with tempered glass diffuser lens. Hinged electrical access lid gives access to internal electrical components. All hardware is stainless steel.

Electrical

120V through 277V 50/60 Hz electronic driver. 0-10V dimming. -40°C start temperature. Available with optional ANSI C136.41 twist lock receptacle or Wattstopper FSP-211 photo/motion. Rama ships prewired and fully assembled.

Light Engine

High powered LEDs mounted to a RoHS compliant circuit board with PMMA optics affixed to each LED on the board. Available in 2700K, 3000K, and 4000K. >80 CRI across all available color temperatures.

Distributions

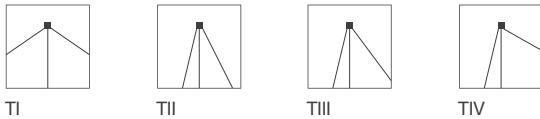

Warranty

Urbidermis Santa & Cole guarantees the composition and performance features of all material that shape the product for a period of three years. Electrical components including LED boards and electronic drivers are guaranteed for a period of five years.

Certification

UL Listed for Wet Location, CE, International Dark Sky Approved, RoHS Compliant



Designed by Gonzalo Mila for Urbidermis Santa & Cole

LED Configurations

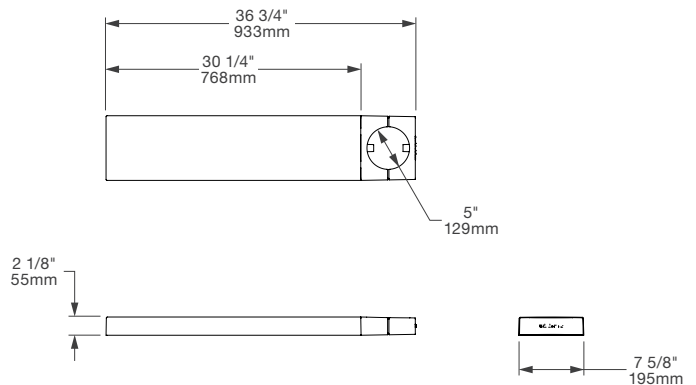
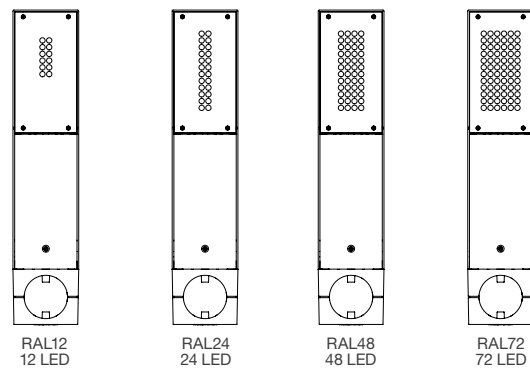

Weight: 20lbs (luminaire only)
EPA: 1.06ft²

TM21 L70(10k): 50,000hrs
Protection Class: IP66

Rama Area Light

landscapeforms®

Product Data Sheet | RAL

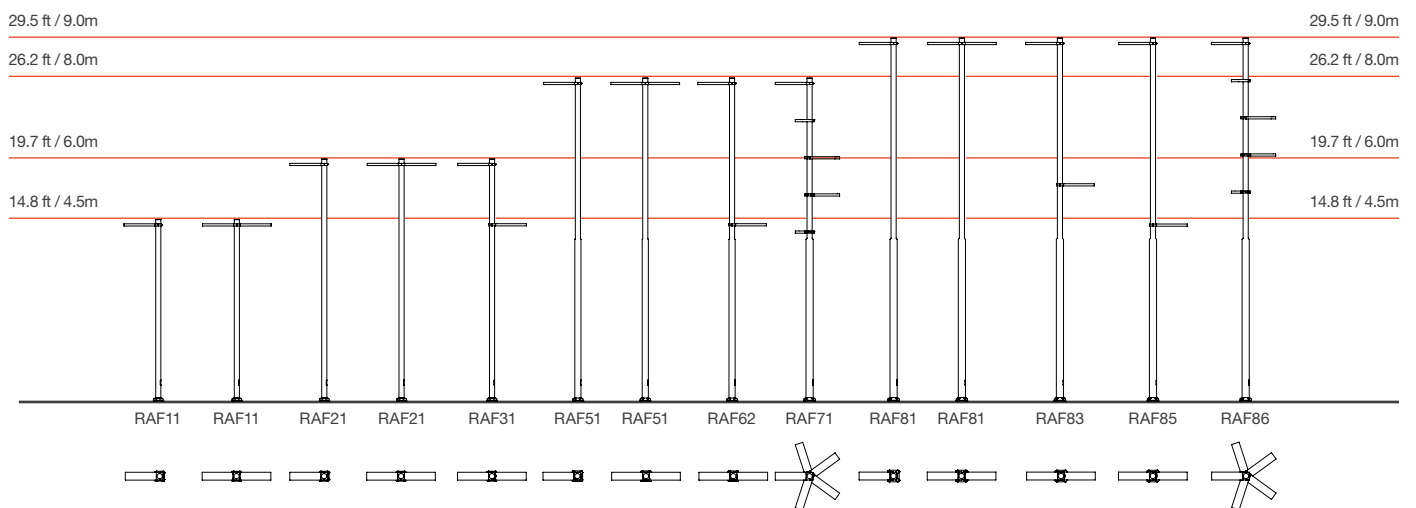

See customer drawings for luminaire mounting height details.

Pole

Manufactured from seamless 6063 aluminum alloy and heat treated to produce a T6 temper. Flush mounted hand hole cover includes two magnicoated fasteners. Base plate is cast aluminum A356 alloy heat treated to a T6 temper and includes four cast aluminum nut covers. Mounting template and anchor hardware is also included. Anchor bolts conform to ASTM F1554 Grade 55 and are provided with two hex nuts and two flat washers. Bolts have an "L" bend on one end and are galvanized a minimum of 12" on the threaded end.

Photo/motion sensor



Click [here](#) to view the technical data sheet for the photo/motion sensor.

Twist lock receptacle

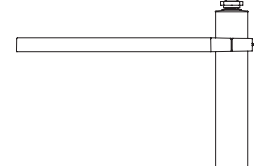

Mounting

The luminaire attaches to a 5" diameter section of pole using a cast aluminum two-piece compression clamp. For single mount applications, a cast aluminum back clamp is secured to the luminaire using stainless steel screws. For double mount applications, the luminaires are mounted directly (back-to-back) to each other. For tenon mount retrofit applications, the luminaire slip fits a 2-3/8 O.D. tenon and is secured by 6 stainless steel set screws.

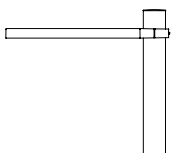

Single Mount Bracket
RAA01

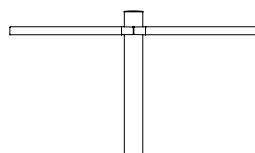

Double Mount Bracket
RAA02

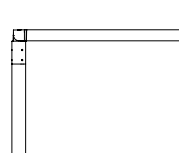

Tenon Retrofit Mount Bracket
RAA06

Rama Area Light

landscapeforms®

Product Data Sheet | RAL

Performance Data

Model	Lamp Power	System Power	LED Quantity	CCT	Drive Current	Type I (TI) IES Type I		Type II (TII) IES Type II		Type III (TIII) IES Type III	
						Delivered Lumens*	Efficacy*	Delivered Lumens*	Efficacy*	Delivered Lumens*	Efficacy*
RAL12A1xx	TBD	14	12	2700K 80 CRI	350	1349	95	1481	105	1394	99
RAL12B1xx	TBD	20			500	1835	91	2014	100	1897	94
RAL12C1xx	TBD	28			700	2392	84	2624	92	2471	87
RAL12A2xx	TBD	14		3000K 80 CRI	350	1349	95	1481	105	1394	99
RAL12B2xx	TBD	20			500	1835	81	2014	100	1897	94
RAL12C2xx	TBD	28			700	2392	84	2624	92	2471	87
RAL12A3xx	TBD	14		4000K 80 CRI	350	1552	112	1703	122	1604	115
RAL12B3xx	TBD	20			500	2111	106	2316	117	2181	110
RAL12C3xx	TBD	28			700	2751	98	3018	108	2842	102
RAL24A1xx	TBD	27	24	2700K 80 CRI	350	2656	99	2914	109	2744	103
RAL24B1xx	TBD	38			500	3612	95	3963	104	3732	98
RAL24C1xx	TBD	54			700	4707	87	5165	96	4864	90
RAL24A2xx	TBD	27		3000K 80 CRI	350	2656	99	2914	109	2744	103
RAL24B2xx	TBD	38			500	3614	95	3963	104	3732	98
RAL24C2xx	TBD	54			700	4707	87	5165	96	4864	90
RAL24A3xx	TBD	26		4000K 80 CRI	350	3054	116	3351	127	3156	120
RAL24B3xx	TBD	38			500	4154	111	4559	121	4293	114
RAL24C3xx	TBD	53			700	5414	102	5940	112	5594	106
RAL48A1xx	TBD	51	48	2700K 80 CRI	350	5366	105	5888	115	5545	108
RAL48B1xx	TBD	73			500	7299	100	8009	109	7542	103
RAL48C1xx	TBD	103			700	9811	92	10437	101	9828	95
RAL48A2xx	TBD	51		3000K 80 CRI	350	5366	105	5888	115	5545	108
RAL48B2xx	TBD	73			500	7299	100	8099	109	7542	103
RAL48C2xx	TBD	103			700	9511	92	10437	101	9828	95
RAL48A3xx	TBD	50		4000K 80 CRI	350	6172	122	6772	134	6378	127
RAL48B3xx	TBD	72			500	8395	117	9212	128	8675	121
RAL48C3xx	TBD	102			700	10939	108	12004	118	11304	111
RAL72A1xx	TBD	77	72	2700K 80 CRI	350	7924	103	8695	112	8189	106
RAL72B1xx	TBD	110			500	10779	98	11827	107	11138	101
RAL72C1xx	TBD	156			700	14046	90	15412	99	14514	93
RAL72A2xx	TBD	77		3000K 80 CRI	350	7924	103	8695	112	8189	106
RAL72B2xx	TBD	110			500	10779	98	11827	107	11138	101
RAL72C2xx	TBD	156			700	14046	90	15412	99	14541	93
RAL72A3xx	TBD	76		4000K 80 CRI	350	9114	120	10001	131	9418	124
RAL72B3xx	TBD	109			500	12397	114	13603	125	12811	118
RAL72C3xx	TBD	153			700	16155	106	17727	116	16694	109

This data is subject to change.

*Apply 0.93 multiplier for opal / diffused lens option.

Rama Area Light

Product Data Sheet | RAL

Performance Data (cont.)

Model	Lamp Power	System Power	LED Quantity	CCT	Drive Current	Type IV (TIV) IES Type IV	
						Delivered Lumens*	Efficacy†
RAL12A1xx	TBD	14	12	2700K 80 CRI	350	1450	103
RAL12B1xx	TBD	20			500	1973	98
RAL12C1xx	TBD	28			700	2571	91
RAL12A2xx	TBD	14		3000K 80 CRI	350	1450	103
RAL12B2xx	TBD	20			500	1973	98
RAL12C2xx	TBD	28			700	2571	91
RAL12A3xx	TBD	14		4000K 80 CRI	350	1668	120
RAL12B3xx	TBD	20			500	2269	115
RAL12C3xx	TBD	28			700	2957	106
RAL24A1xx	TBD	27	24	2700K 80 CRI	350	2854	107
RAL24B1xx	TBD	38			500	3882	102
RAL24C1xx	TBD	54			700	5059	94
RAL24A2xx	TBD	27		3000K 80 CRI	350	2854	107
RAL24B2xx	TBD	38			500	3882	102
RAL24C2xx	TBD	54			700	5059	94
RAL24A3xx	TBD	26		4000K 80 CRI	350	3283	125
RAL24B3xx	TBD	38			500	4465	119
RAL24C3xx	TBD	53			700	5819	110
RAL48A1xx	TBD	51	48	2700K 80 CRI	350	5769	113
RAL48B1xx	TBD	73			500	7845	108
RAL48C1xx	TBD	103			700	10223	99
RAL48A2xx	TBD	51		3000K 80 CRI	350	5768	113
RAL48B2xx	TBD	73			500	7845	108
RAL48C2xx	TBD	103			700	10223	99
RAL48A3xx	TBD	50		4000K 80 CRI	350	6634	132
RAL48B3xx	TBD	72			500	9023	126
RAL48C3xx	TBD	102			700	11758	116
RAL72A1xx	TBD	77	72	2700K 80 CRI	350	8518	111
RAL72B1xx	TBD	110			500	11586	105
RAL72C1xx	TBD	156			700	15097	97
RAL72A2xx	TBD	77		3000K 80 CRI	350	8518	111
RAL72B2xx	TBD	110			500	11586	105
RAL72C2xx	TBD	156			700	15097	97
RAL72A3xx	TBD	76		4000K 80 CRI	350	9797	129
RAL72B3xx	TBD	109			500	13325	123
RAL72C3xx	TBD	153			700	17364	114

This data is subject to change.

*Apply 0.93 multiplier for opal / diffused lens option.

Rama Area Light

landscapeforms®

Product Data Sheet | RAL

RAL12B2TI

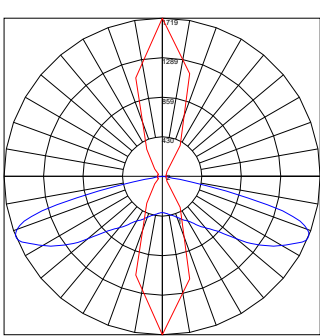

Maximum Candela=1718.94
Located at Horizontal Angle=90,
Vertical Angle=67

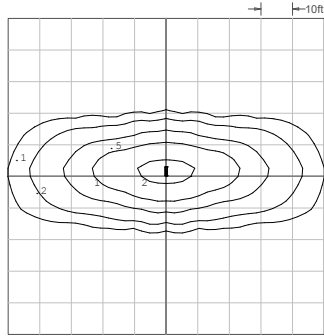

4.2m (13.8ft) pole, single luminaire depicted.

RAL12B2TII

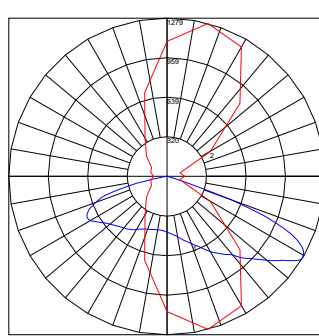

Maximum Candela=1278.64
Located at Horizontal Angle=75,
Vertical Angle=59

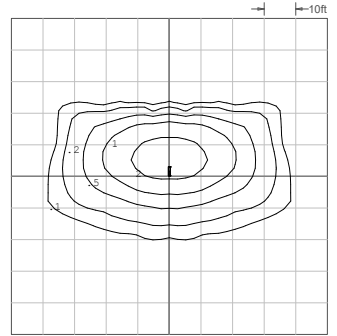

4.2m (13.8ft) pole, single luminaire depicted.

RAL12B2TIII

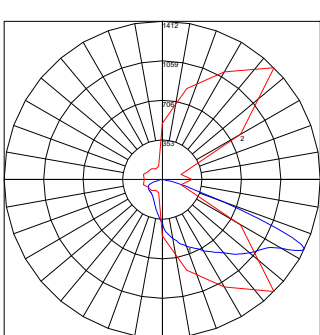

Maximum Candela=1411.5
Located at Horizontal Angle=45,
Vertical Angle=64

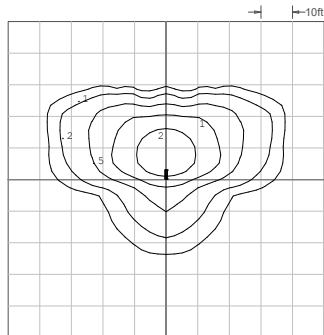

4.2m (13.8ft) pole, single luminaire depicted.

RAL12B2TIV

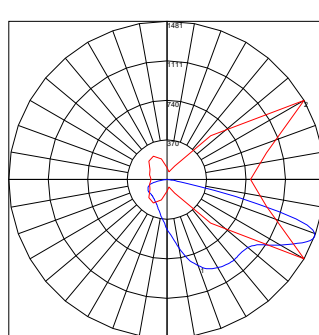

Maximum Candela=1480.85
Located at Horizontal Angle=30,
Vertical Angle=69

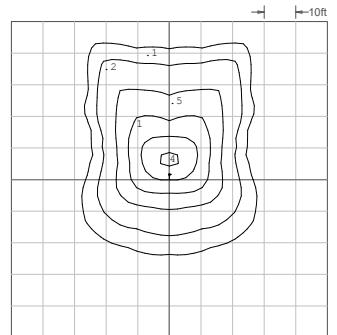

4.2m (13.8ft) pole, single luminaire depicted.

RAL24B2TI

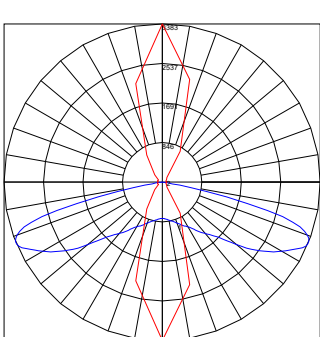

Maximum Candela=3382.95
Located at Horizontal Angle=90,
Vertical Angle=67

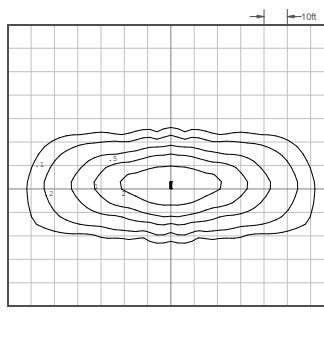

4.7m (15.4ft) pole, single luminaire depicted.

RAL24B2TII

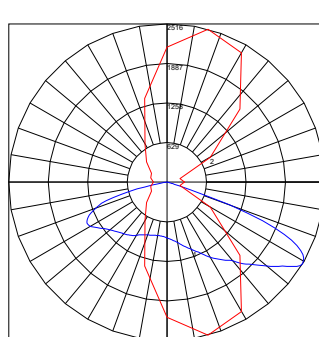

Maximum Candela=2516.42
Located at Horizontal Angle=75,
Vertical Angle=59

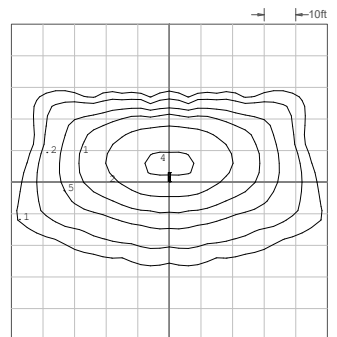

4.7m (15.4ft) pole, single luminaire depicted.

Rama Area Light

Product Data Sheet | RAL

RAL24B2TIII

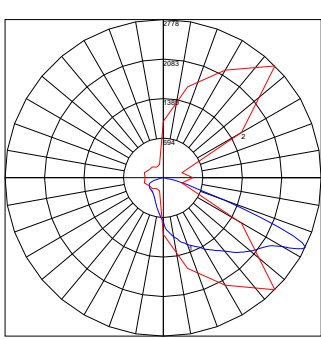

Maximum Candela=2777.89
Located at Horizontal Angle=45,
Vertical Angle=64

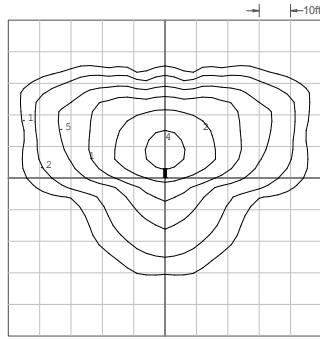

4.7m (15.4ft) pole, single luminaire depicted.

RAL24B2TIV

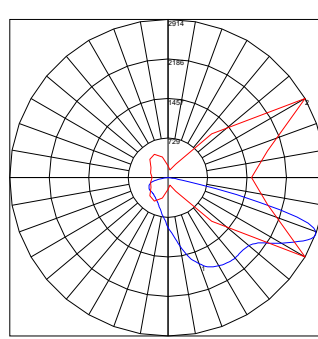

Maximum Candela=2914.38
Located at Horizontal Angle=30,
Vertical Angle=69

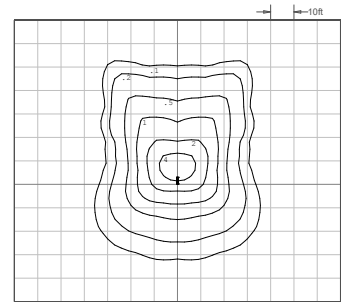

4.7m (15.4ft) pole, single luminaire depicted.

RAL48B2TI

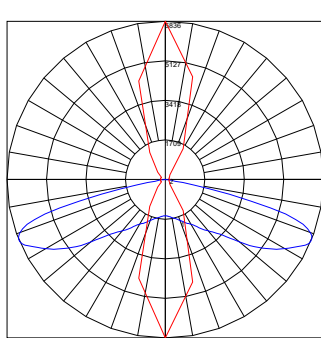

Maximum Candela=6836.02
Located at Horizontal Angle=90,
Vertical Angle=67

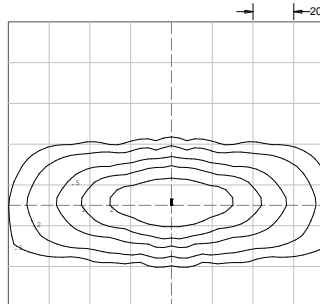

6.2m (19.7ft) pole, single luminaire depicted.

RAL48B2TII

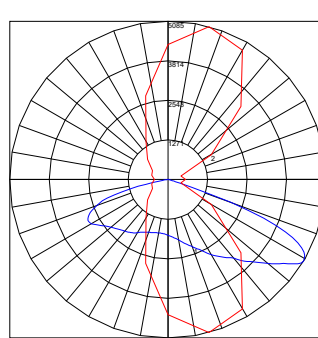

Maximum Candela=5085.01
Located at Horizontal Angle=75,
Vertical Angle=59

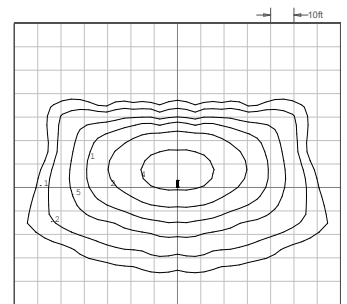

6.2m (19.7ft) pole, single luminaire depicted.

RAL48B2TIII

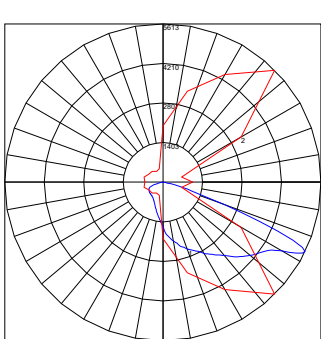

Maximum Candela=5613.36
Located at Horizontal Angle=45,
Vertical Angle=64

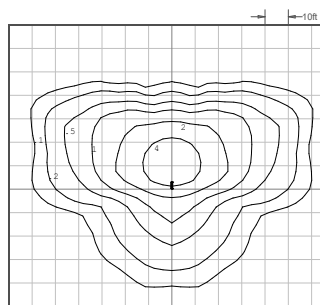

6.2m (19.7ft) pole, single luminaire depicted.

RAL48B2TIV

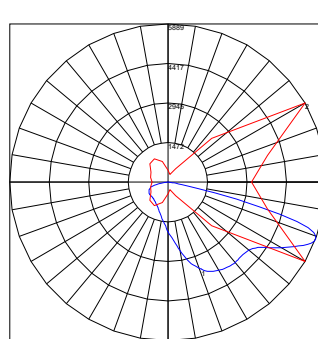

Maximum Candela=5889.17
Located at Horizontal Angle=30,
Vertical Angle=69

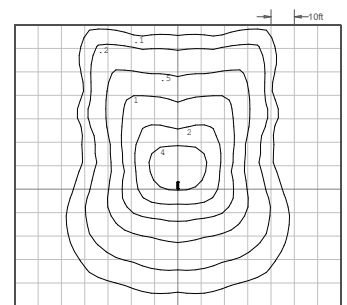

6.2m (19.7ft) pole, single luminaire depicted.

Rama Area Light

landscapeforms®

Product Data Sheet | RAL

RAL72B2TI

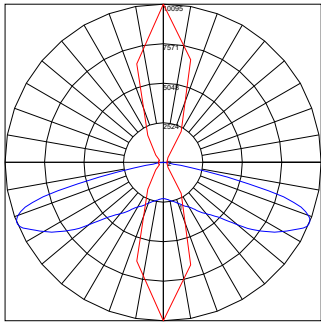

Maximum Candela=10095.2
Located at Horizontal Angle=90,
Vertical Angle=67

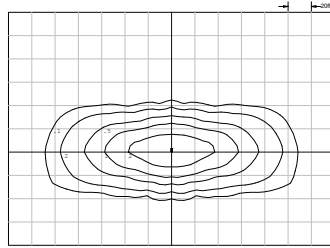

8.2m (26.9ft) pole, single luminaire depicted.

RAL72B2TII

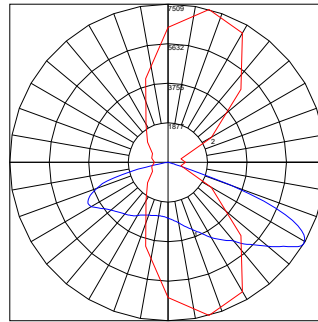

Maximum Candela=7509.37
Located at Horizontal Angle=75,
Vertical Angle=59

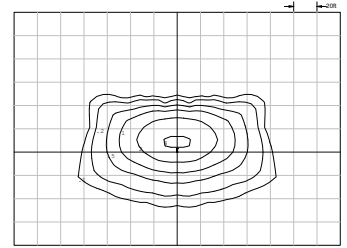

8.2m (26.9ft) pole, single luminaire depicted.

RAL72B2TIII

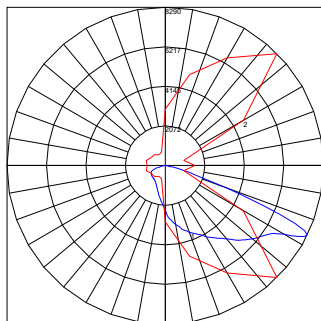

Maximum Candela=8289.62
Located at Horizontal Angle=45,
Vertical Angle=64

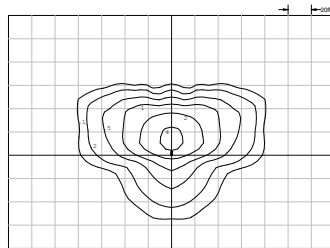

8.2m (26.9ft) pole, single luminaire depicted.

RAL72B2TIV

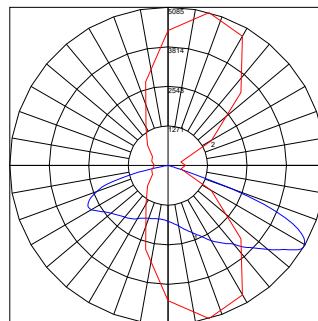

Maximum Candela=5085.01
Located at Horizontal Angle=75,
Vertical Angle=59

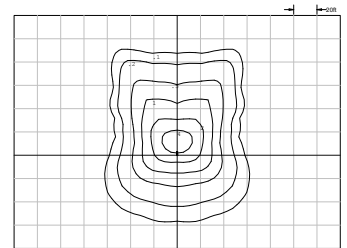

8.2m (26.9ft) pole, single luminaire depicted.

Rama Area Light

landscapeforms®

Specification Sheet | RAL

Luminaire

Product	LED Configuration	Drive Current	Color Temperature	Distribution	Lens	Photo/Motion Sensor
RAL	12	A (350mA)	1 (3000K)	TI (Type 1)	Null (Clear)	NMS (No Motion Sensor)
	24	B (500mA)	2 (4000K)	TII (Type 2)	O (Opal/ Diffused)	MS1 (With Motion Sensor)
	48	C (700mA)	3 (2700K)	TIII (Type 3)		
	72			TIV (Type 4)		

Example: RAL – 12 – B – 1 – TII – O – MS1 – Powdercoat

Mounting Accessories

Product	Bracket
RAA	01 (Single Mount)
	02 (Double Mount)
	06 (Tenon Retrofit Mount)

Example: RAA – 01 – Powdercoat

Pole

Height	Pole No.	Mounting	Diameter	Wall Thickness	Weight
4.5m (14.8 ft)	RAF11	(1) or (2) Luminaires at Top	Straight 5" (127mm)	0.125" (3.175mm)	43 lbs
6.0m (19.7 ft)	RAF21	(1) or (2) Luminaires at Top	Straight 5" (127mm)	0.188" (4.775mm)	72 lbs
6.0m (19.7 ft)	RAF31	(1) Luminaire at Top, (1) Luminaire at 4.3m (14.1 ft)	Straight 5" (127mm)	0.188" (4.775mm)	72 lbs
8.0m (26.2 ft)	RAF51	(1) or (2) Luminaires at Top	Stepped 7" (177.8mm) / 5" (127mm)	0.188" (4.775mm) / 0.125" (3.175mm)	128 lbs
8.0m (26.2 ft)	RAF62	(1) Luminaire at Top, (1) Luminaire at 4.3m (14.1 ft)	Stepped 7" (177.8mm) / 5" (127mm)	0.188" (4.775mm) / 0.125" (3.175mm)	128 lbs
8.0m (26.2 ft)	RAF71	(5) Luminaires in Spiral Configuration	Stepped 7" (177.8mm) / 5" (127mm)	0.188" (4.775mm) / 0.125" (3.175mm)	128 lbs
9.0m (29.5 ft)	RAF81	(1) or (2) Luminaires at Top	Stepped 7" (177.8mm) / 5" (127mm)	0.188" (4.775mm) / 0.125" (3.175mm)	142 lbs
9.0m (29.5 ft)	RAF83	(1) Luminaire at Top, (1) Luminaire at 4.5m (14.8 ft)	Stepped 7" (177.8mm) / 5" (127mm)	0.188" (4.775mm) / 0.125" (3.175mm)	142 lbs
9.0m (29.5 ft)	RAF85	(1) Luminaire at Top, (1) Luminaire at 5.6m (18.4 ft)	Stepped 7" (177.8mm) / 5" (127mm)	0.188" (4.775mm) / 0.125" (3.175mm)	142 lbs
9.0m (29.5 ft)	RAF86	(5) Luminaires in Spiral Configuration	Stepped 7" (177.8mm) / 5" (127mm)	0.188" (4.775mm) / 0.125" (3.175mm)	142 lbs

Control Options

Twist Lock Receptacle
T

Example: RAF54- T - Powdercoat

Rama Area Light

landscapeforms®

Material / Colors Sheet | RAL

Luminaire & Mounting Brackets*



Aluminum Silver



Dusk

Powdercoated Metal (Gloss; Poles Only)**



Black



Stormcloud



Dusk

Powdercoated Metal (Metallic; Poles Only)**



Silver



Titanium



Mercury**

Designer Palette Architectural Series (Low Sheen; Poles Only)**

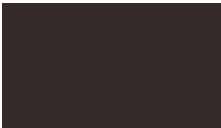

Matte Black

Rama Area Light

landscapeforms®

Material / Colors Sheet | RAL

Powdercoated Metal

Powdercoated Metal Pangard II® Polyester Powdercoat is a hard, yet flexible, finish that resists rusting, chipping, peeling and fading. In addition to colors shown, a wide selection of optional and custom colors may be specified for an upcharge.

- * LED luminaire colors shown are the color options offered from Urbidermis Santa & Cole.
- ** All colors and patterns shown are approximate and may vary from sample and final.
- *** Mercury from Landscape Forms is our recommended color match for Aluminum Silver from Urbidermis Santa & Cole.

Visit landscapeforms.com for more information. Specifications are subject to change without notice. Landscape Forms supports the Landscape Architecture Foundation at the Second Century level.

©2021 Landscape Forms, Inc. Printed in U.S.A.

landscapeforms.com | specify@landscapeforms.com



K829 AURORA SR. - LED



King Luminaire

The K829 Aurora Sr. provides a gently curved, shrouded fixture, designed to increase roadway performance while providing superior spacing. Suitable for off road-way applications as well, this time-less design can be used in both contemporary and historical settings. A 3/4 scaled version of this fixture is also available.

PRODUCT SPECIFICATIONS

LED ENGINE

Light engine shall include an array of 60 or 84 solid state Cree X-Series high power LEDs (light emitting diodes). The emitters shall be mounted to a metal core circuit board using SMT technology. The LEDs and circuit boards shall then be mounted to a high performance heat sink which is vented to the outside ambient air to provide dynamic airflow for cooling the system.

OPTICS

External light control shall consist of high precision refractive lenses mounted above the LED emitter arrays in such a way to achieve optimum uplight control. The lenses shall also control horizontal light distribution so that Type II, III, IV or V IESNA distribution patterns are achieved.

LENS

The K829 Aurora Sr. pendant is available with or without a lens. Lens options include; clear sag glass lens; clear shallow glass lens; rippled acrylic deep dish lens or rippled glass deep dish lens. The sag and shallow glass lens shall be made of #9000 clear borosilicate glass (fully annealed). It shall maintain a minimum thickness of 0.3". The rippled acrylic deep dish globe shall be moulded of acrylic Acrylite Plus Acrylic Polymer, or equivalent, having a minimum thickness of 0.09". The rippled glass deep dish lens shall be made of clear borosilicate glass (fully annealed) with a rippled pattern. It shall maintain a minimum thickness of 0.25". The lens is secured by means of a cast aluminum holding ring. Additionally, a continuous circular gasket rated for 270°F will assist in sealing the lens and provide an IP66 ingress rating.

LUMINAIRE CONSTRUCTION

The luminaire shall consist of an aluminum alloy housing that acts as the enclosure for the engine and is of adequate thickness to give structural rigidity. The engine must be affixed to the inside of the housing with stainless steel screws.

The bottom decorative portion of the K829 Aurora Sr. fixture is comprised of a one-piece spun aluminum alloy with a minimum thickness of 0.09". The spinning is permanently affixed to the cast housing with the use of stainless steel hardware.

PLUMBIZER

The K829 Aurora Sr. comes with multiple mounting options including the KPL10, KPL11, KPL20, KPL21, KPL30, KPL31 and KPL40. Please contact King Luminaire for more details and specifications.

DRIVER

The LED universal dimmable driver will be class 2 and capable of 120 - 277V or 347 - 480V input voltage, greater than 0.9 power factor, less than 20% total harmonic distortion. The case temperature of the driver can range from -40°C to 70°C. Each LED system comes with a standard surge protection designed to withstand up to 20kV/10kA of transient line surge as per IEEE C62.41.2 C High. An in-line ferrite choke is utilized to provide protection against EFT's. The driver assembly will be mounted on a heavy duty fabricated aluminum bracket to allow complete tool-less maintenance. Dimming capable using 1-10vdc (10% to 100%), 10v PWM, or resistance.

PHOTOMETRICS

Fixtures are tested to IESNA LM79 specifications. These reports are available upon request.

CHROMATICITY

High output LEDs come standard at 3000K & 4000K (+/- 300K) with a minimum nominal 70 CRI. Additional CCT emitters are available upon request.

LUMEN MAINTENANCE

Reported (TM21) and Calculated (L70) reports are available upon request with a minimum calculated value of 100,000 hrs.

WIRING

All internal wiring and connections shall be completed so that it will be necessary only to attach

the incoming supply connectors to Mate-N-Lok connectors or to a terminal block. Mate-N-Lok shall be certified for 600V operation. Internal wire connectors shall be crimp connector only and rated at 1000V and 150°C. All wiring to be CSA certified and/or UL listed, type SFF-2, SEWF-2, or SEW-2 No. 14 gauge, 150°C, 600V, and color coded for the required voltage.

THERMALS

Fixtures tested to DOE sanctioned standards to determine the maximum in-situ solder-point or junction-point temperatures of the LED emitters. This report is available upon request.

FINISH

Housing is finished with a 13 step KingCoat™ SuperDurable polyester TGIC powder coat. Standard colors include strobe white, brown metal, marina blue, gate gray, Chicago bronze, standard gold, standard black, federal green and rain forest. Please see our website for a complete list of colors. RAL and custom color matches are available.

MISCELLANEOUS

All exterior hardware and fasteners, wholly or partly exposed, shall be stainless steel alloy. All internal fasteners are stainless steel or zinc coated steel. All remaining internal hardware is stainless steel, aluminum alloy, or zinc coated steel.

WARRANTY

The K829 Aurora Sr. LED luminaire comes with a 7 year limited warranty.

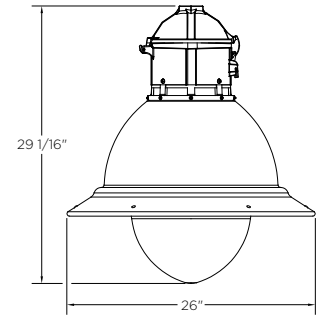

CERTIFICATION:

CSA US Listed
Suitable for wet locations
ISO 9001
IP66
ARRA Compliant
LM79 / LM80 Compliant

DRIVER INFO:

>0.9 Power Factor
<20% Total Harmonic Distortion
120 - 277V & 347 - 480V
-40°C Min. Case Temperature
70°C Max. Case Temperature
Surge Protection: ANSI C136.2
extreme level 20kV/10kA
Dimming Capable: 1-10vdc

EPA:

Flat Lens:	1.61 sq. ft.
Sag Lens:	1.71 sq. ft.
Shallow Lens:	2.03 sq. ft.
Deep Dish Acrylic:	2.48 sq. ft.
Deep Dish Glass:	2.48 sq. ft.

FIXTURE WEIGHT:

Flat Lens:	32 lbs
Sag Lens:	37 lbs
Shallow Lens:	40 lbs
Deep Dish Acrylic:	40 lbs
Deep Dish Glass:	45 lbs



Not all product variations listed on this page are DLC qualified. Visit www.designlights.org/search to confirm qualification. Contact King Luminaire for product specifications that are exempt from CSA Certification. 08-11-2021

Lens Options

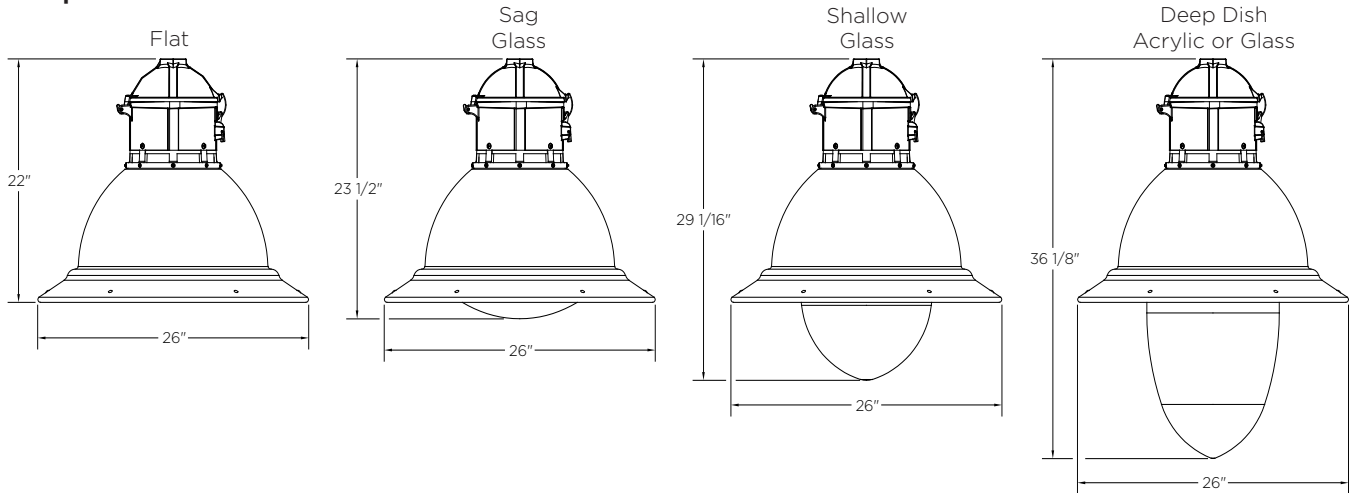

Plumbizer/Mounting Options

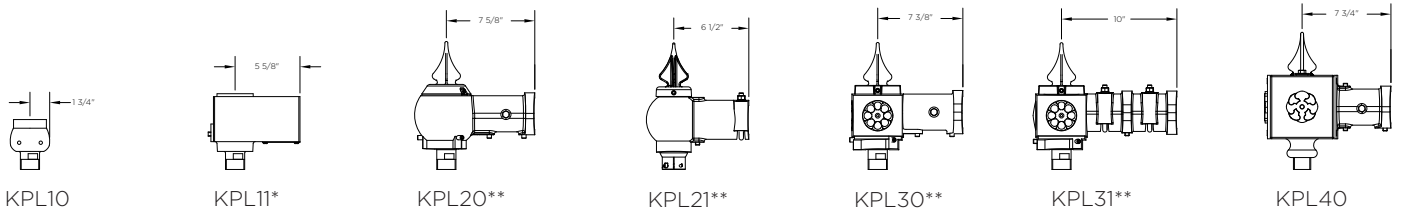

*Available with PR7
 **Available with PR7 or finial

HOW TO ORDER

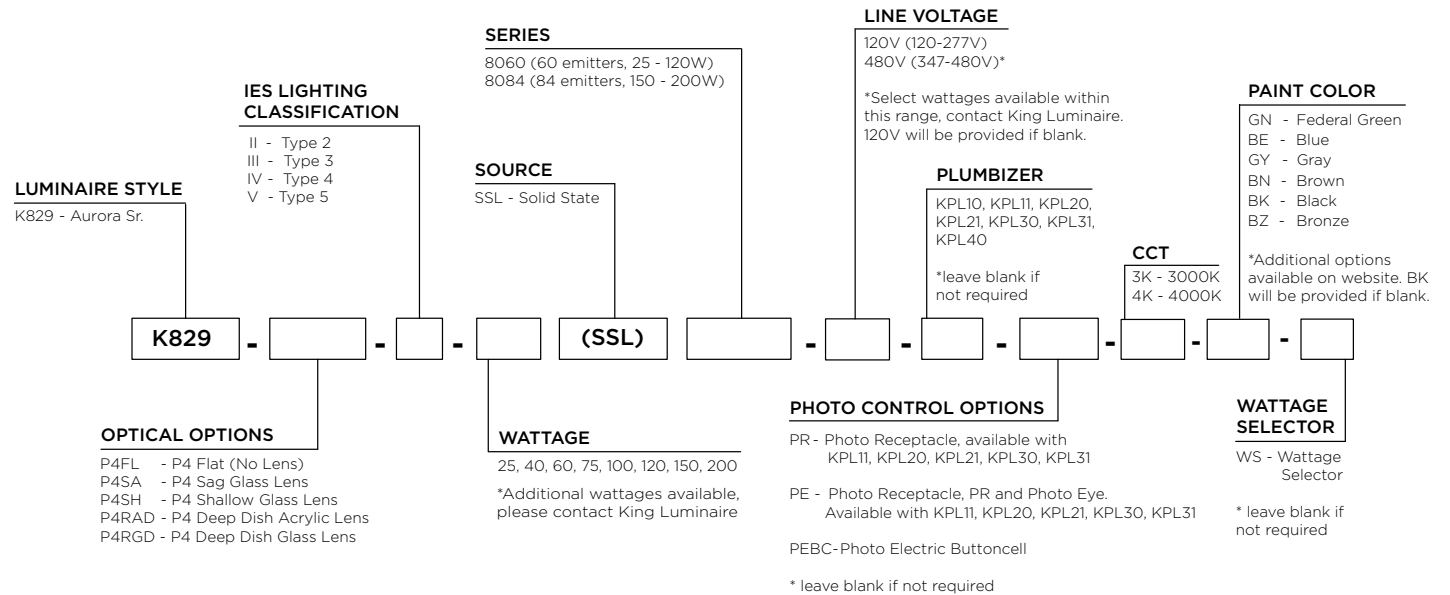

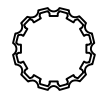
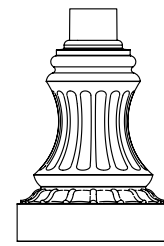

5"
Straight Flat
Fluted
w/3" tenon

Project: _____
 Location: _____
 Cat.No: _____
 Type: _____
 Lamps: _____ Qty: _____
 Notes: _____

Order guide

example: P2065 10 A T D

Product Code	Pole Height	Finish	Outlet Location	Outlet Options
P2065				
P2065	10' 12' 14' 16'	A Black B White G Verde H Bronze J Green	T 12" Down from Top - Aligned with House Side B 4" Up from Top of Base - Aligned with House Side	D Standard Duplex G GFI Duplex

EPA values based on destructive break testing. For AASHTO ratings, contact factory.

Pole Data

Pole Model	Pole Shape	Pole Type	Shaft Dimension	Pole Fluted	Anchor Base Shape	Bolt Circle	Base Dim (in)	Hand Hole Dim (in)
P2065	Round	Straight	5	Fluted	round	8 to 12	16 x 21	5 x 8

Pole Family	Catalog Number	Nominal Height (ft)	Tenon Section (in)	Wall Thickness (in)	EPA Rating 80 MPH (sq. ft)	EPA Rating 100 MPH (sq. ft)	Anchor Bolts (in)
P2065	P2065-10	10	3	0.188 - 0.267	25.34	15.00	3/4-19 bs
P2065	P2065-12	12	3	0.188 - 0.267	21.11	12.30	3/4-19 bs
P2065	P2065-14	14	3	0.188 - 0.267	14.38	8.24	3/4-19 bs
P2065	P2065-16	16	3	0.188 - 0.267	11.78	6.34	3/4-19 bs

Specifications

HOUSING:

356 HM high-strength, low-copper, proprietary cast aluminum alloy. 6005-T5 extruded aluminum. Anchor rods are hot dipped galvanized steel. Tenon is 356 HM sand cast aluminum.

FINISH:

A durable polyurethane enamel finish is applied after assemblies are shot blasted to create a surface profile which allows for the highest level of paint adhesion. Laboratory tested for superior weatherability and fade resistance in accordance with ASTM B-117-64 and ANSI/ASTM G53-77 specifications. For larger projects where a custom color is required, contact the factory for more information.

WARRANTY:

Please visit www.signify.com/warranties for more details on structural and finish warranty.

OUTLET:

Standard Duplex Outlet has universal metal weatherproof cover. Weatherproof while in use. Heavy-duty all-metal construction. Lockable security cover. Meets NEC 406.9 (B). Weather resistant. GFI Duplex Outlet has dual-function indicator light, universal metal weatherproof cover. Weatherproof while in use. Heavy-duty all-metal construction. Lockable security cover. Meets NEC 406.9 (B). Weather resistant.

P2065 Poles and Brackets

Straight Round Fluted

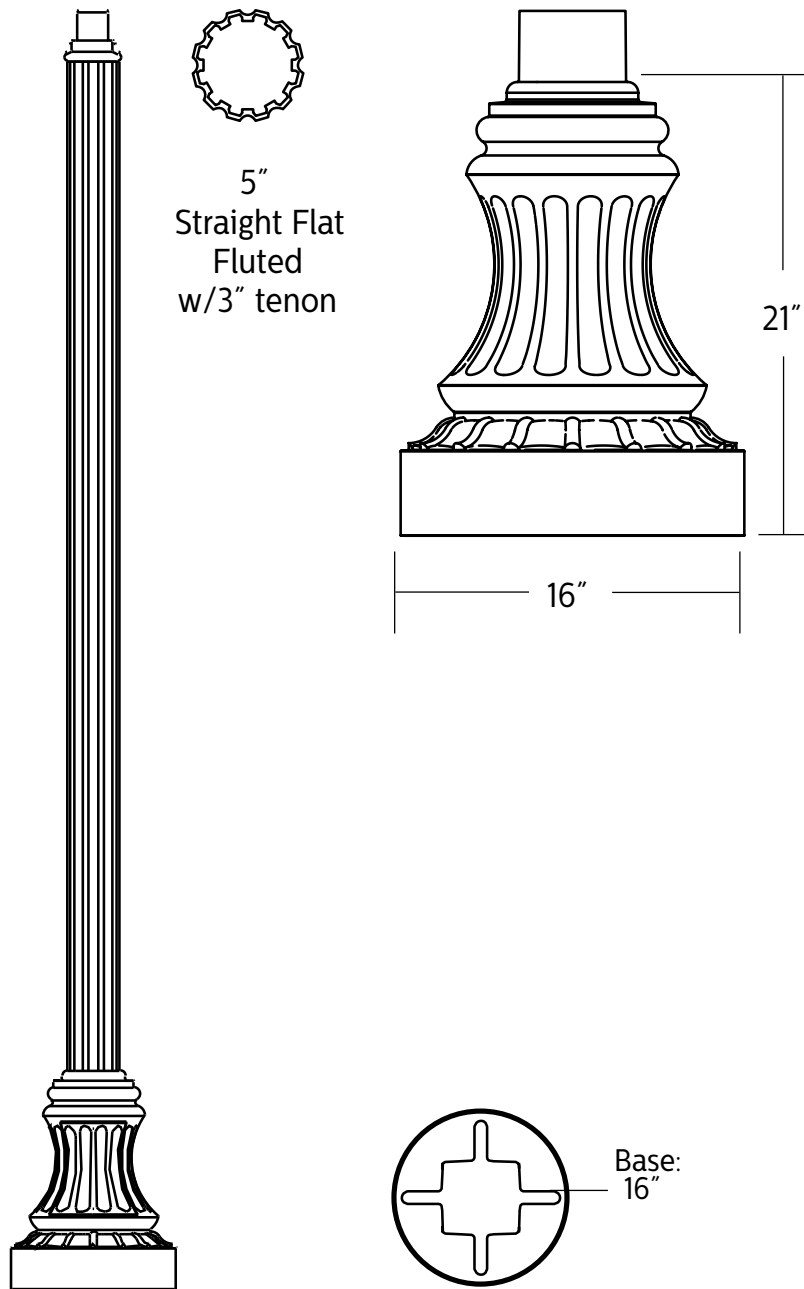

The information presented in this document is not intended as any commercial offer and does not form part of any quotation or contract.



GreenCobra™ LED Street Light

GCL J-Series Specification Data Sheet

Luminaire Data

Weight 19 lbs [8.7 kg]
EPA 0.52 ft.²

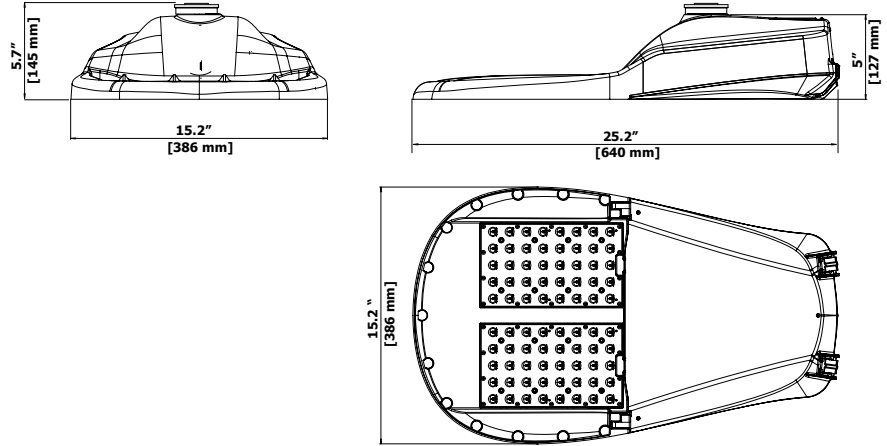

Ordering Information

Sample Catalog No. GCL1-80J-MV-30K-2S-GY-185-PCR7-RWG

Model*	LED Code	Voltage	Color Temperature	Distribution	Finish ¹	Output Code ²	Options
GCL1* GCL2*	80J	MV 120-277V HV 347-480V	30K 3000K 40K 4000K 50K 5000K	2S Type 2 Short 2R Type 2 Medium 3R Type 3 Medium 3F Type 3F 4 Type 4 5 Type 5	GY Gray DB Dark Bronze BK Black	Refer to Page 3 to select the performance code.	FOC ³ Fixed Output Code LPCR Less Photocontrol Receptacle PCR7 ⁴ ANSI 7-wire Photocontrol Receptacle PCR7-CR ⁵ Control Ready 7-wire Photocontrol Receptacle 4B 4-Bolt Slip-Fitter RWG Rubber Wildlife Guard WL Utility Wattage Label BBL Bubble Level DSC Door Safety Cable CF ⁶ Coastal Paint Finish SP2 ⁷ Extreme Surge Protection, 20KV/10KA, Fail-to-on LSSP2 ⁷ Extreme Surge Protection, Fail-to-off, 20kv/10KA Rating

* Refer to performance data table on page 3 for specific model with corresponding output code

Notes:

- 1 Gray, Black and Dark Bronze standard. Consult factory for other finishes. See page 2 for RAL codes of Standard finishes.
- 2 Specified output code is the factory set lumen performance. Refer to performance data table on page 3 of this spec sheet. Field adjustable output selector enables fixture to be changed in the field to adjust light output for local conditions (not available with Fixed Output Code, FOC) or PCR7-CR option. Consult factory if wattage limits require a special drive current.
- 3 Non-field adjustable, fixed output code. Specify required output code. Not available with PCR7-CR option.
- 4 Includes output selector that enables field adjustability of light levels. Includes connectors to allow easy upgrade of wireless dimming via PCR7. Wireless node by others.
- 5 Control-ready wired at factory for wireless node dimming (node by others). Output selector not included in the fixture. Not able to adjust above specified output code.
- 6 Specify the CF Option for coastal installation. See warranty for details.
- 7 Standard surge protection, 10kV/5kA, fail-to-on, meets enhanced surge protection based on ANSI 136.25-2015 3-part test.
- 8 Flush mounted house side shield. Shield cuts light off at 1 mounting height behind luminaire. Same shield as H-Series product. Black color.
- 9 Flush mounted cul-de-sac shield. Shield cuts light off at 1 mounting height behind luminaire and 2 times the mounting height on either side of luminaire. Same shield as H-Series product. Black color.
- 10 Flush mounted front side shield cuts light off at approximately 1½ mounting height in front of luminaire (street side). Same shield as H-Series product. Black color.
- 11 Specify Color (GY, DB, BK). Refer to Leotek web site for specific mounting details and drawings at <https://leotek.com/lighting-library/>
- 12 Specify MV (120-277V) or HV (347V-480V)

Accessories*

HSSGCL ⁸	House Side Shield, Snap-On*
CSSGCL ⁹	Cul-De-Sac Side Shield, Snap-On*
FSSGCL ¹⁰	Front Side Shield, Snap-On*
SPB ¹¹	Square Pole Horizontal Arm Bracket
RPB ¹¹	Round Pole Horizontal Arm Bracket
PTB ¹¹	Pole Top Tenon Horizontal Arm Bracket
PTB2 ¹¹	Pole Top Tenon Horizontal Arm Bracket (2@180°)
WB ¹¹	Wall Horizontal Arm Bracket
BSK	Bird Deterrent Spider Kit
LLPC ¹²	Long-Life Twist Lock Photocontrol
SC	Twist Lock Shorting Cap

*Unless specified for field installation, Shields are installed and Shorting Cap is included in the box. All other options are shipped separately.

Luminaire Specifications

Housing

Die cast aluminum housing with universal two-bolt slip fitter mounts to 1-1/4" to 2" (1-5/8" to 2-3/8" O.D.) diameter mast arm. One-piece aluminum housing provides passive heat-sinking of the LEDs and has upper surfaces that shed precipitation. Four-bolt mounting bracket (4B option) is available. Mounting provisions meet 3G vibration per ANSI C136.31-2010 Normal Application, Bridge & Overpass by independent test lab. Mounting has leveling adjustment from ± 5° in 2.5° steps. All hardware is stainless steel. Electrical components are accessed without tools via die cast aluminum door with stainless steel quick release latches. Provided standard with removable polycarbonate wild life guard. For additional protection, optional rubber wildlife guard (RWG) which conforms snugly to the mast arm is offered.

Light Emitting Diodes

LEDs produce minimal 90% of initial intensity at 60,000 hours of life per IES recommended lumen maintenance life projection based on 6 times the duration of the collected LM-80 data. For details on IESNA Position on LED Product Lifetime Prediction, PS-10-18. LEDs have correlated color temperature of 3000K (WW), 4000K (NW), or 5000K (CW) and 70 minimum CRI. LEDs are ROHS compliant, 100% mercury and lead free.

Field Adjustability

LED lumen output can be changed in the field to adjust light output for local conditions (not available with PCR7-CR option). The specified output code will be the factory set output. Field adjustments can be made with the output selector included in the fixture. Field adjustable range shown in performance data table.

Quality Control

Every luminaire is performance tested before and after a 2-hour burn-in period. Assembled in the USA.

Optical Systems

Micro-lens optical systems produce IESNA Type 2, Type 3, Type 4, or Type 5 distributions and are fully sealed to maintain an IP66 rating. Luminaire produces 0% total lumens above 90° (BUG Rating, U=0). Optional house side shield cuts light off at 1/2 mounting height behind luminaire. Front side shield cuts light off at approximately one mounting height in front of the luminaire (street side). Cul-de-sac shield provides back and side light control for end of cul-de-sac applications. All shields are field installable without tools.

Electrical

Rated life of electrical components is 100,000 hours. Uses isolated power supply that is 1-10V dimmable. Power supply is wired with quick-disconnect terminals. EMC meets or exceeds FCC CFR Part 15. Terminal block accommodates 6 to 14 gauge wire. Surge protection complies with IEEE/ANSI C62.41 Category C High, 10kV/5kA and ANSI C136.2-2015, 3-part test.

Power Supply

IP66 rated power power supply with high power factor of > 90%. Auto sensing universal AC input from 120 to 277VAC (MV model) and 347 to 480VAC (HV mode) rated for both line to line and line to neutral applications. Maximum THD rating of 20%. Class 1 or Class 2. Built-in overheating protection mechanism will reduce drive current to LEDs and electrical components if the driver experiences unusual internal overheating situation. Built-in short circuit, voltage overload, and current overload protection with automatic recovery after correction.

Controls

3-Wire photocontrol receptacle is standard. ANSI C136.41 7-wire (PCR7) photocontrol receptacle is available. All photocontrol receptacles have tool-less rotatable base. Wireless control module is provided by others.

Finish

Housing receives a durable, fade-resistant polyester powder coat finish with 3.0 mil nominal thickness. Standard finish tested to withstand 5000 hours in salt spray exposure per ASTM B117 and Coastal Finish per ASTM G85. Finish meets scribe creepage rating 8 per ASTM D1654. Finish tested 500 hours in UV exposure per ASTM G154 and meets ASTM D523 gloss retention.

Listings/Ratings/Labels

Luminaires are UL listed for use in wet locations in the United States and Canada. DesignLights Consortium™ qualified product. Consult DLC QPL for Standard and Premium Classification Listings. All electronic components inside of the luminaire are NRTL damp location rated per ANSI 136.37-2011 Ingress Protection standard. International Dark Sky Association listed. Luminaire is qualified to operate at ambient temperatures of -40°C to 40°C. Assembled in the U.S.A

Photometry

Luminaires photometrics are tested by certified independent testing laboratories in accordance with IES LM-79 testing procedures.

Warranty

10-year limited warranty is standard on luminaire and components. See Leotek.com for warranty details.

Vandal Resistance

Housing and optics rated to IK10

Certification and Compliance

Luminaire complies with:
ANSI: C136.2, C136.3, C136.10, C136.13, C136.15, C136.22, C136.31, C136.35, C136.37, C136.41, C62.41, C78.377, C82.77
Other: FCC 47 CFR, IEC 60598, ROHS II, UL 1449, UL 1598

Color Specifications

Order Code	Color	RAL #	Pantone Equivalent
GY	Gray	7040	429C
BK	Black	9004	426C
DB	Dark Bronze	6022	BLACK 2C

TM21 Lumen Maintenance per IES TM21-11 Calculation

Model Number	60,000 Hours*	80,000 Hours	100,000 Hours
All GCL 80J	>98%	>98%	>98%

*Calculation based on IES position statement on Lumen Maintenance Life Projections

Performance Data: 3000K (30K)

All data nominal. IES files for all CCTs available at leotek.com.

Product	LED Code	Output Code	System Wattage (W)	Delivered Lumens (Lm)	Efficacy (Lm/W) ¹	System Drive Current (mA) ²	Field Adjustable Output Range
GCL1	80J	185	123	18338	149	500	↕
		195	132	19448	147	540	
		210	146	21073	144	595	
		220	153	21803	143	625	
		240	171	23848	139	700	
GCL2	80J	225	161	22626	138	640	↕
		240	173	23845	138	690	
		250	183	24949	136	725	
		260	193	25894	134	765	
		275	206	27033	131	830	

Notes:

1. Nominal lumens. Normal tolerance $\pm 10\%$ due to factors including distribution type, LED bin variance, and ambient temperatures.
2. System drive current values are the same as LED drive current values.

Performance Data: 4000K (40K) and 5000K (50K)

All data nominal. IES files for all CCTs available at leotek.com.

Product	LED Code	Output Code	System Wattage (W)	Delivered Lumens (Lm)	Efficacy (Lm/W) ¹	System Drive Current (mA) ²	Field Adjustable Output Range
GCL1	80J	190	123	19209	156	500	↕
		205	132	20350	154	540	
		220	146	22216	152	595	
		230	153	23129	151	625	
		255	171	25504	149	700	
GCL2	80J	235	161	23667	147	640	↕
		250	173	25229	146	690	
		265	183	26444	145	725	
		275	193	27567	143	765	
		295	206	29252	142	830	

Notes:

1. Nominal lumens. Normal tolerance $\pm 10\%$ due to factors including distribution type, LED bin variance, and ambient temperatures.
2. System drive current values are the same as LED drive current values.

BUG Ratings: 3000K (30K)

All data nominal. IES files for all CCTs are available at leotek.com.

		Type 2R	Type 2S	Type 3R	Type 3F	Type 4	Type 5
Product & LED Code	Output Code	BUG Rating	BUG Rating	BUG Rating	BUG Rating	BUG Rating	BUG Rating
GCL1 80J	185	B3-U0-G3	B3-U0-G2	B3-U0-G3	B3-U0-G3	B3-U0-G3	B4-U0-G2
	195	B3-U0-G3	B3-U0-G2	B3-U0-G3	B3-U0-G3	B3-U0-G3	B4-U0-G2
	210	B3-U0-G3	B3-U0-G3	B3-U0-G3	B3-U0-G3	B3-U0-G3	B4-U0-G2
	220	B3-U0-G3	B3-U0-G3	B3-U0-G3	B3-U0-G3	B3-U0-G3	B4-U0-G2
	240	B3-U0-G3	B3-U0-G3	B3-U0-G3	B3-U0-G3	B4-U0-G3	B4-U0-G2
GCL2 80J	225	B3-U0-G3	B3-U0-G2	B3-U0-G3	B3-U0-G3	B3-U0-G3	B4-U0-G2
	240	B3-U0-G3	B3-U0-G3	B3-U0-G3	B3-U0-G3	B3-U0-G3	B4-U0-G2
	250	B3-U0-G3	B3-U0-G3	B3-U0-G3	B3-U0-G3	B4-U0-G3	B5-U0-G3
	260	B3-U0-G3	B3-U0-G3	B3-U0-G3	B3-U0-G4	B4-U0-G3	B5-U0-G3
	275	B3-U0-G3	B4-U0-G3	B3-U0-G3	B3-U0-G4	B4-U0-G3	B5-U0-G3

BUG Ratings: 4000K (40K) and 5000K (50K)

All data nominal. IES files for all CCTs are available at leotek.com.

		Type 2R	Type 2S	Type 3R	Type 3F	Type 4	Type 5
Product & LED Code	Output Code	BUG Rating	BUG Rating	BUG Rating	BUG Rating	BUG Rating	BUG Rating
GCL1 80J	190	B3-U0-G3	B3-U0-G2	B3-U0-G3	B3-U0-G3	B3-U0-G3	B4-U0-G2
	205	B3-U0-G3	B3-U0-G2	B3-U0-G3	B3-U0-G3	B3-U0-G3	B4-U0-G2
	220	B3-U0-G3	B3-U0-G2	B3-U0-G3	B3-U0-G3	B3-U0-G3	B4-U0-G2
	230	B3-U0-G3	B3-U0-G3	B3-U0-G3	B3-U0-G3	B3-U0-G3	B4-U0-G2
	255	B3-U0-G3	B3-U0-G3	B3-U0-G3	B3-U0-G4	B4-U0-G3	B5-U0-G3
GCL2 80J	235	B3-U0-G3	B3-U0-G3	B3-U0-G3	B3-U0-G3	B3-U0-G3	B4-U0-G2
	250	B3-U0-G3	B3-U0-G3	B3-U0-G3	B3-U0-G3	B4-U0-G3	B5-U0-G3
	265	B3-U0-G3	B3-U0-G3	B3-U0-G3	B3-U0-G4	B4-U0-G3	B5-U0-G3
	275	B3-U0-G3	B3-U0-G3	B3-U0-G3	B3-U0-G4	B4-U0-G3	B5-U0-G3
	295	B3-U0-G3	B4-U0-G3	B4-U0-G4	B3-U0-G4	B4-U0-G4	B5-U0-G3

Optical Distribution

(Each square block represents one mounting height, MH)

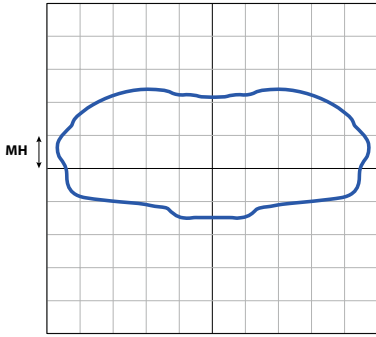

Type 2R

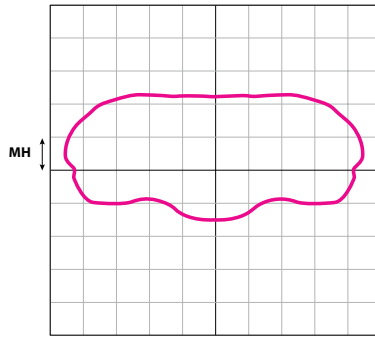

Type 2S

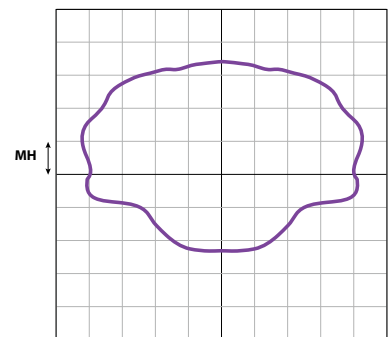

Type 3F

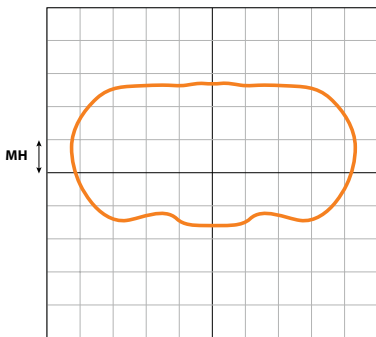

Type 3R

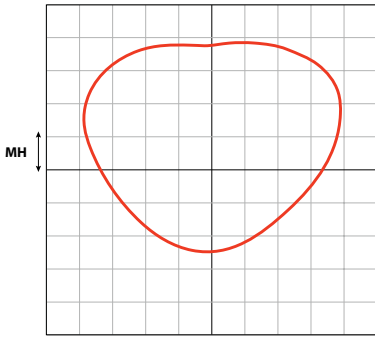

Type 4

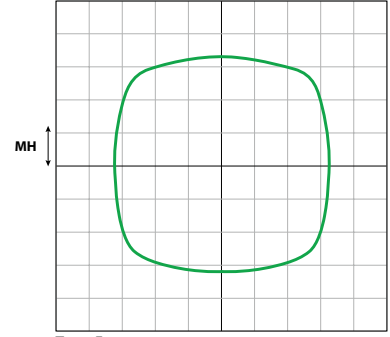

Type 5

35 Collection

landscapeforms®

Product Data Sheet



Loop

- Loop bike rack is a simple, sweeping circle with a twist.
- Both functional and sculptural.
- Cyclists can loop and lock one or two bikes around its shape-shifting cast aluminum ribbon frame.
- The aluminum casting, finished with Pangard II® powdercoat, is offered in a selection of colors. Must be embedded to a concrete surface.
- Refer to install guide for spacing guidelines.
- Meets APBP guidelines.

Metal Finishes

- All metal is finished with Pangard II®, offered exclusively by Landscape Forms, a 19-step program of cleaning, priming, and powder coating that resists rusting, chipping, peeling and fading to produce the finest metal finish available for site furniture. In addition, Pangard II® contains no heavy metals and is free of Hazardous Air Pollutants.
- Call for standard color chart.

Recycled Content

- Loop has a recycled content of 97%, and is 100% recyclable.

To Specify

- Specify collection name and product name.

Loop design is protected by U.S. Patent No. D754,032

	Style	Depth	Length	Height	Product Weight
	bike rack	14"	36"	31"	25 lb



DERO
A PLAYCORE Company



Cycle Stall Basic

One car or ten bikes? Maximize parking for customers at your business with on-street bike parking. The Cycle Stall Basic kit covers the needs of cities and businesses that want to provide an on-street bike corral at a low cost and minimal changes to infrastructure. Kit includes parking delineators.

Cycle Stall Basic



Have It Your Way.

Cycle Stalls can be made out of many of our standard bike racks.

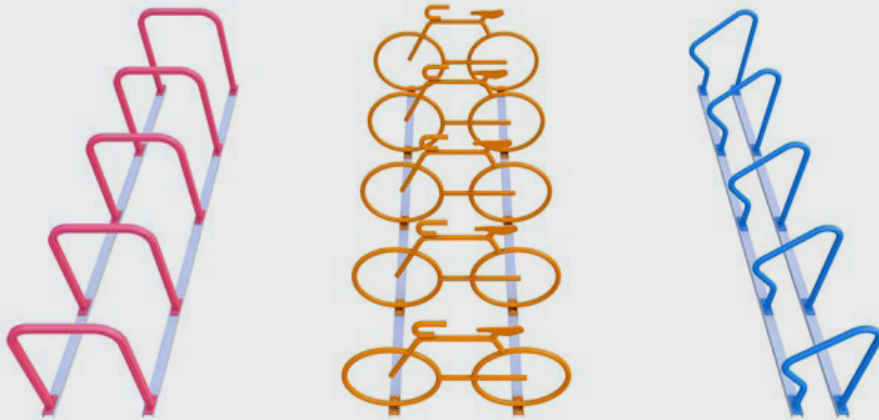

FINISH OPTIONS

Galvanized



PVC Dip



Powder Coat

- | | | | | |
|-------------------------|--------------------|-------------------------|-----------------------|--------------------------|
| White | Black | Light Gray
RAL 7042 | Deep Red
RAL 3003 | Yellow
RAL 1023 |
| CNH Bright
Yellow | Orange
RAL 2004 | Beige
RAL 1001 | Iron Gray
RAL 7011 | Hunter Green
RAL 6005 |
| Light Green
RAL 6018 | Green
RAL 6016 | Sepia Brown
RAL 8014 | Blue
RAL 5005 | Sky Blue
RAL 5015 |
| Dark Purple | Flat Black | Wine Red
RAL 3005 | Bronze | Silver
RAL 9007 |

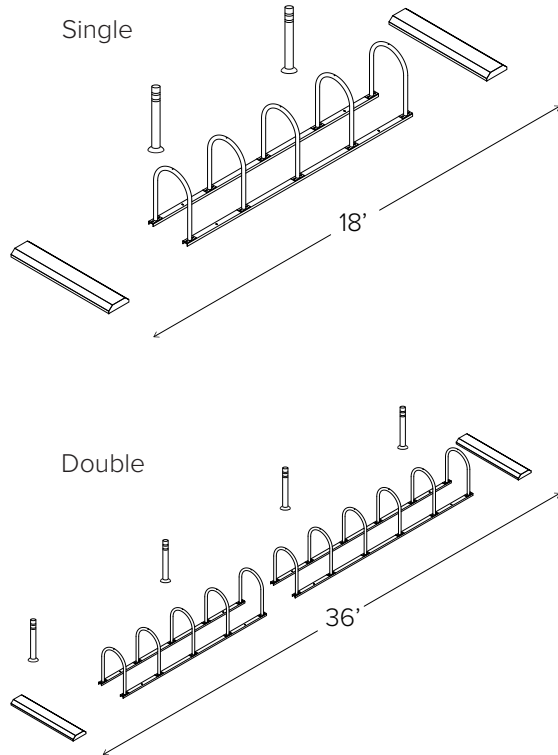

Traffic delineators are included in either yellow (standard) or white.

CAPACITY
Single: 10 Bikes
Double: 22 Bikes

MATERIALS
Hoop Racks: 1.5" schedule 40 pipe (1.9" OD)
Wheel Stops: Recycled plastic.

FINISHES

- Galvanized**
 An after fabrication hot dipped galvanized finish is our standard option.
- Powder Coat (Racks Only)**
 Our powder coat finish assures a high level of adhesion and durability by following these steps:
 1. Sandblast
 2. Epoxy primer electrostatically applied
 3. Final thick TGIC polyester powder coat

MOUNT OPTIONS

- Rail**
 Rail Mounted Racks are bolted to two parallel rails which can be left freestanding or anchored to the ground. Rails are heavy duty 3"x1.4"x3/16" thick galvanized mounting rails. Specify rail mount for this option.

RACK OPTIONS

- Arc Rack**
- Bike Bike Rack**
- Downtown Rack**
- Hoop Rack**
- Hoop Rack Heavy Duty**
- Swerve Rack**

RACK ANGLE

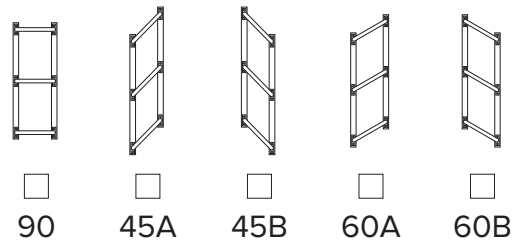

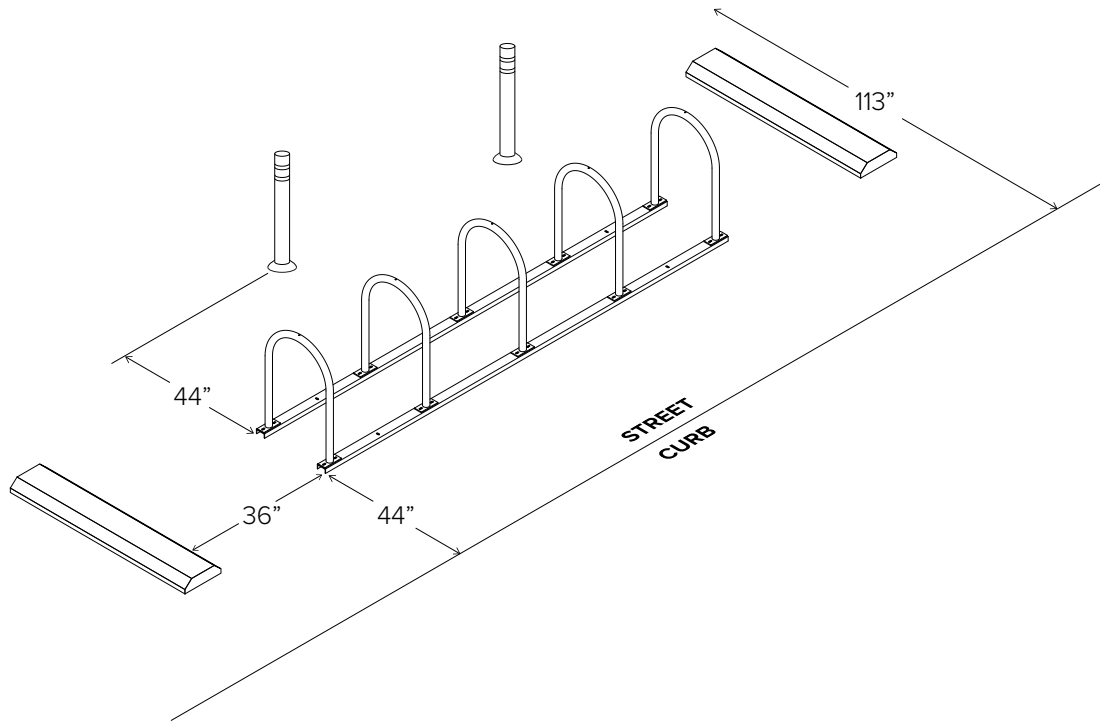



TOOLS NEEDED

9/16" Socket set
 Two 4"x4"x28" (or larger) blocks
 Four bolts, nuts and washers for every rack (included with rack). If using a tamper resistant nuts, install two tamper resistant nuts with each rack.
 Hammer (if installing into concrete with wedge anchors)

ANCHORING THE RAILS

Once assembled, to anchor the rails to concrete, place 3.75" wedge anchor through 4 indicated holes in the rail into the concrete. Secure with nut.

If anchoring to asphalt surface, use Titen asphalt screws. Place screws through rail holes and turn into the asphalt.

1

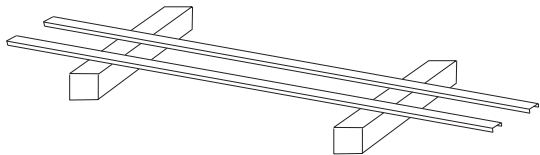

Lay out the two channel beams where the rack will be placed. Place the two beams on top of the two blocks of wood so that the open part of the channel faces the ground.

2

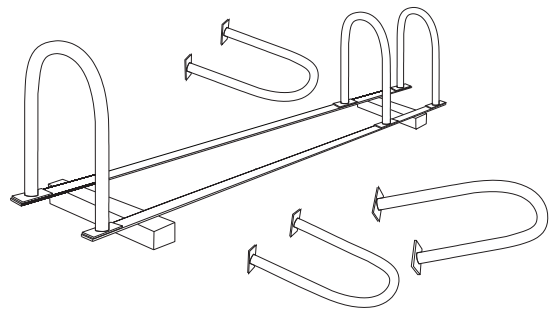

Place racks on beams so holes in rack flanges line up with beam slots.

3

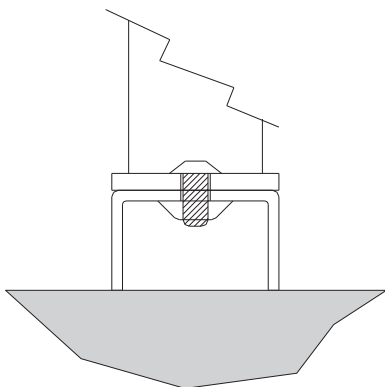

Put bolts through rack flange holes and beams so bolt head faces up. **HAND** tighten the nuts using new flange nuts.

4

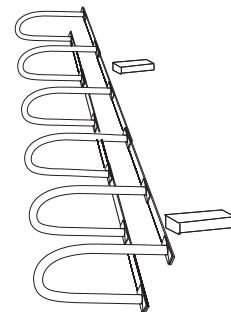

Once nuts are on, tip assembled rack over and use a 9/16" socket to tighten nuts. Before fully tightening nuts, make sure the racks are straight on beams. If using tamper resistant nuts, use access tool to tighten nuts. Do not overtighten the tamper resistant nuts. Tip rack upright.



TOOLS NEEDED

Hammer Drill with 3/8" masonry bit
 Socket Wrench 3/8"
 Hammer (if installing into concrete with wedge anchors)

ANCHORING THE RAILS

Before installation, ensure work site is safe. If necessary, block off the area to prevent vehicle and pedestrian access. Use appropriate signage and work barricades to delineate the work area. Ensure electric power leads and hand tools are safe, in good working condition and only used as per manufacturer's specifications. Remove any potential trip hazards and use appropriate personal safety equipment (safety gloves, safety glasses, safety boots, etc.).

1

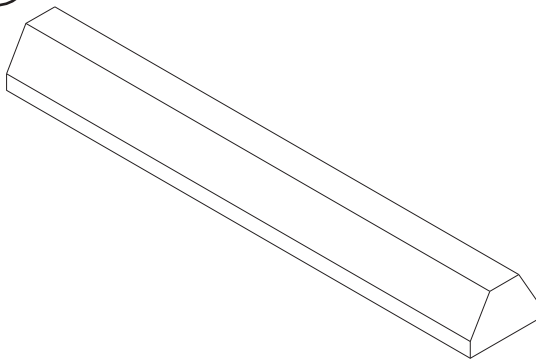

Place wheel stop in desired location using setbacks diagram on page 4 as a guide. Mark holes onto surface and remove wheel stop.

2

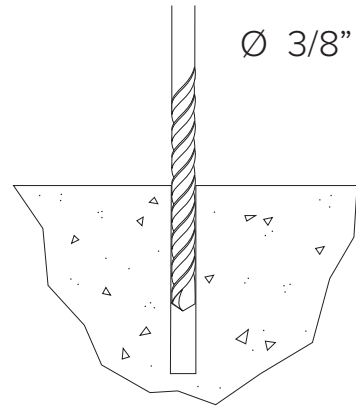

Drill 3/8" holes through asphalt surface.

3

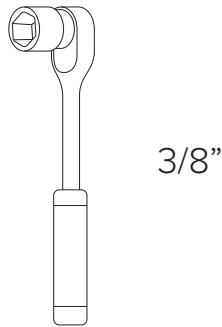

Line up holes in wheel stops with holes in road surface and use 3/8" socket wrench to secure the provided anchors.



Two 48" tall traffic delineators are included to protect your installation from damage by vehicles. Three delineators are included with the double-sized kit.

The delineators are secured to the ground with an epoxy cement and include two bands of reflective tape for greater visibility in low light.

Bins, Bollards & Bicycle Parking

Solid Quattro Bollards

Solid Quattro Bollards are demarcation pillars (75 cm – 30" high). The Bollards consist of four Solid beams (7x7 cm – 3"x3") made from FSC hardwood or Cloudy Grey recyclate with a steel structure. They can be optionally fitted with LED lighting with a connection in the base. The LED strips can be supplied and connected by a local electrician. A removable version is also available if required,

for example in market squares or for emergencies to allow vehicle access.

The base plate can be mounted on a concrete foundation or the galvanised Streetlife ground anchor.

Products supplied within the North American market are fully manufactured in the USA.

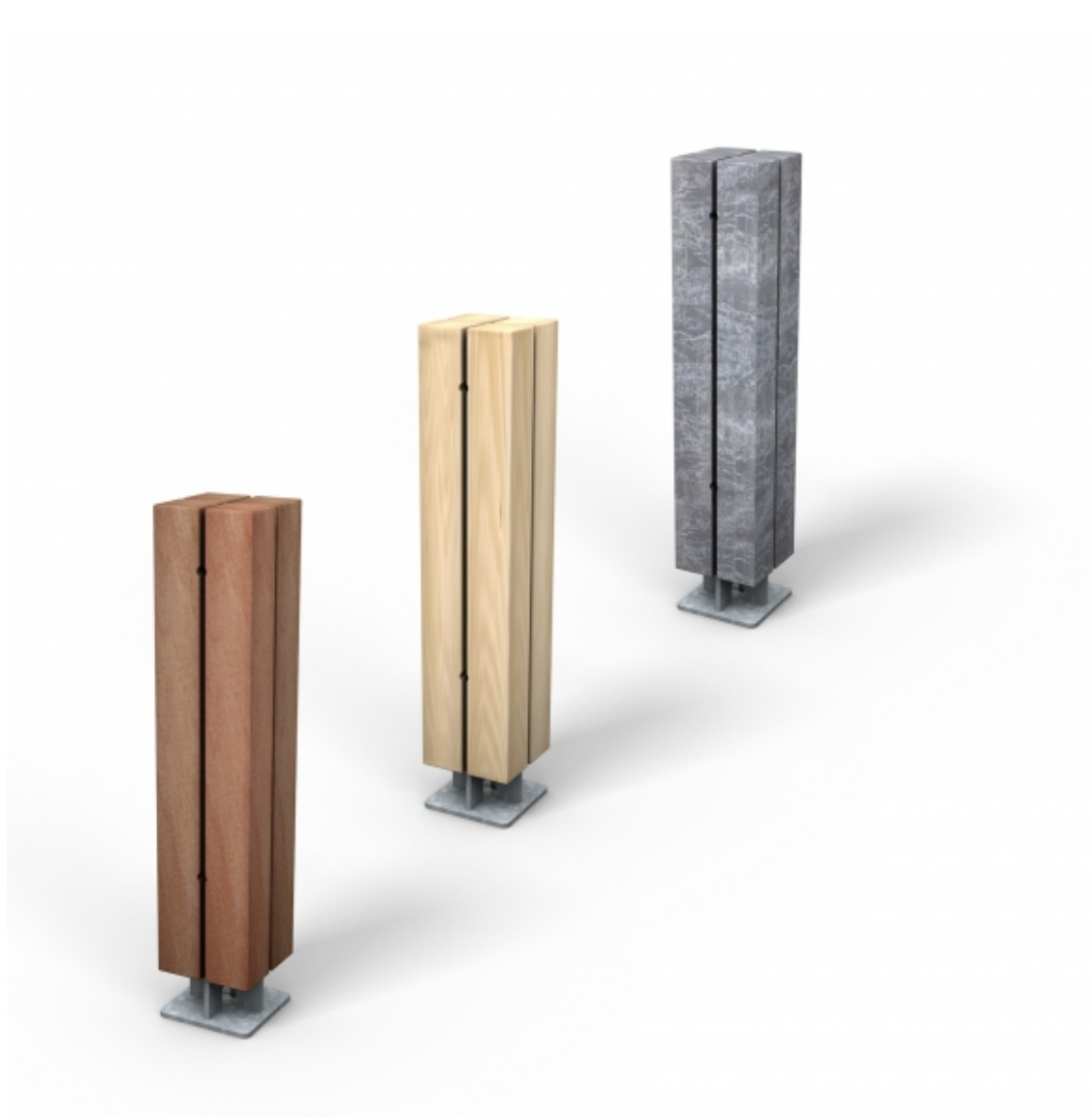

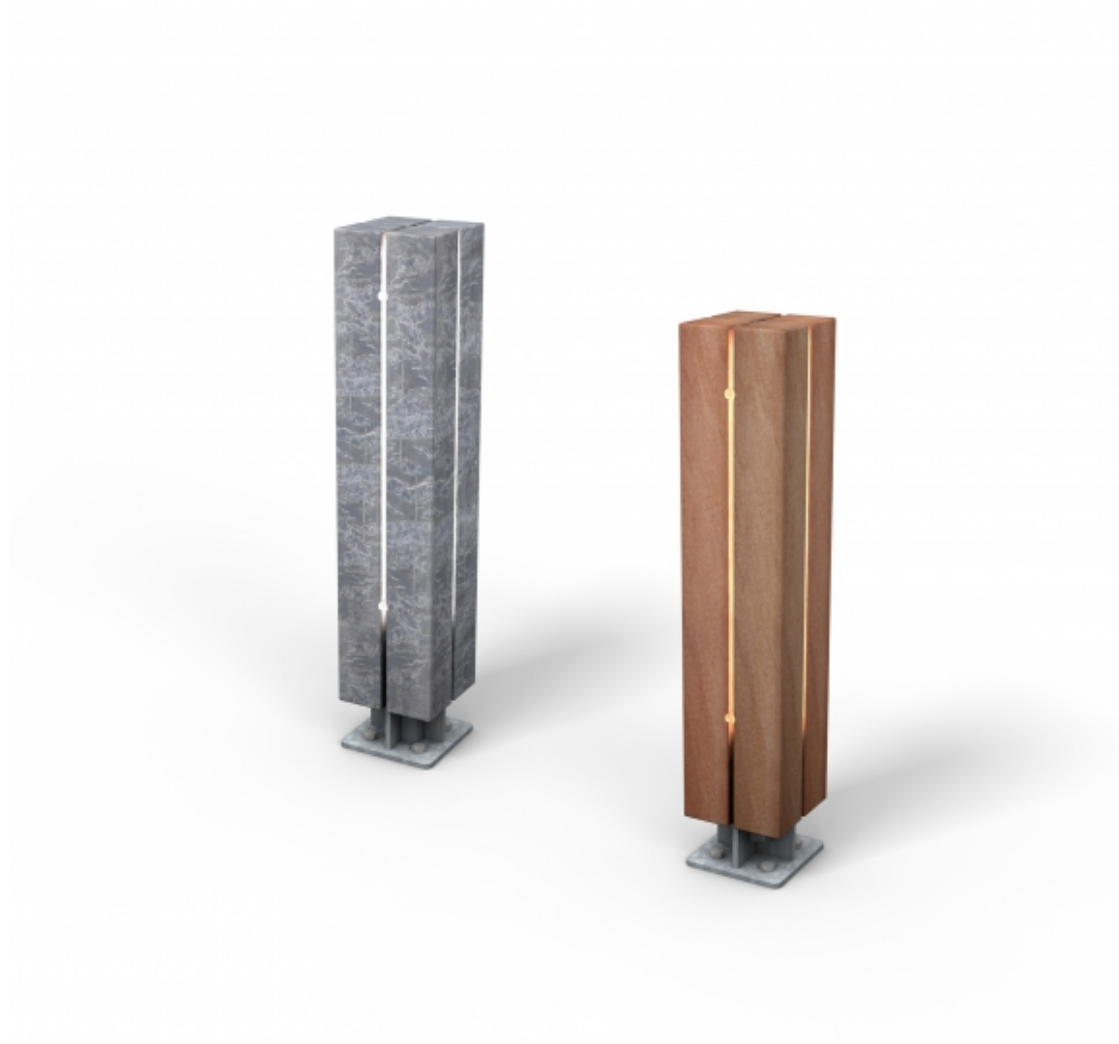

Possibilities and restraints

- Optionally provisions in the wooden beams for mounting LED strips are available

REQUEST QUOTATION OR INFORMATION
([HTTPS://WWW.STREETLIFE.NL/US/REQUEST-QUOTATION](https://www.streetlife.nl/us/request-quotation))



FSC Hardwood II
- Virgin



Cloudy Grey -
Recycled

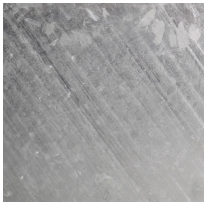

Galvanized Steel



CorTen Steel



Powder Coating

Generation 50

landscapeforms®

Product Data Sheet



Litter Receptacle

- Generation 50 litter is available with a top-open or side-open lid.
- Capacity: 30 Gallon
- Litters are comprised of wood panel sides, powdercoated carbon steel panels and an inner carbon steel frame, with a black polyethylene base.
- The black polyethylene base is prefilled with concrete and then plugged. This allows the unit to be freestanding. There is also a slot in the base to allow for the unit to be surface mounted.
- The litters are available freestanding or surface mount.
- Litter lids and side panels are finished with Pangard II polyester powdercoat.
- 30 GL liner is black roto-molded polyethylene.
- Generation 50 litter ships fully assembled.

Finishes

- Interior woods are finished with Landscape Forms' exclusive LF-80 wood finish, a clear, catalyzed acrylic lacquer.
- Exterior woods are unfinished and will weather to a soft pewter gray, requiring no future maintenance.
- All metal is finished with Landscape Forms' proprietary Pangard II® polyester powdercoat, a hard yet flexible finish that resists rusting, chipping, peeling and fading.



To Specify

Bench:

- Specify Generation 50 bench, backed or backless, select mounting style (if applicable), powdercoat color and wood type. Choose faceboard (curved or straight) and select optional arms.

Litter:

- Specify Generation 50 litter, powdercoat color and wood type. Select side-open and top-open, and mounting style.

	Style	Diameter	Height	Weight
	Top Open	23.25"	39.5"	111 lbs
	Side Open	23.25"	41"	110 lbs

Note: Weights based on jarrah wood

Designed by Robert Chipman

Visit landscapeforms.com for more information. Specifications are subject to change without notice. Landscape Forms supports the Landscape Architecture Foundation at the Second Century level.
©2020 Landscape Forms, Inc. Printed in U.S.A.



TOUCHLESS BOTTLE FILLER SPECIFICATIONS

WATER QUALITY (LEAD FREE)

Section 9, California Proposition 6 and the Federal Safe Drinking Water Act. One piece weld construction with MDF standard 3/16" wall thickness.

STANDARD PEDESTAL

OR

STAINLESS STEEL PEDESTAL

One piece weld construction with MDF standard 304 schedule 10 stainless steel.

RECEPTOR BOWL

18 gauge electro-polished stainless steel bowl. Bowl overlaps pedestal, preventing buildup of residue in visual drinking area. Optional stainless steel Bowl Strainer recommended for areas with sand. Not applicable on Model 10125 SMSS.

BOTTLE FILLER SPOUT

Sanitary recessed nozzle.

BUBBLER HEAD

Self-closing sanitary stainless steel anti-squirt head mounted with a lock nut and washer to prevent tampering. Lock nut pin holds bubbler in locked position to prevent twisting or turning. The MDF bubbler head has a unique design that features a steady stream trajectory and a built in natural shield from contamination.

ELECTRIC EYE

Motion activated. Position electric eyes away from direct sun light.

CONTROL VALVE

Battery powered. Requires (4) AA batteries per valve. This valve is designed to operate and function at 30 to 80 PSI. Ideal operating pressure is 60 PSI.

WATER SUPPLY (LEAD FREE)

Maintenance free reinforced nylobraid tubing - **this tubing is not plastic**. It is supplied with a 1/2" MIP threaded inlet with stainless steel strainer. Union fittings at every connection. Supply line stops above grade. Water Filter is standard on this model.

DRAIN

1 1/2" schedule 40 PVC pipe. Drain line stops above grade.

FINISH

Oven baked powder coat. Choice of colors are: green, blue, black, red, yellow, orange, brown and white. Textured color choices: emerald, sapphire, pyrite, text-black, burgundy, gold vein, copper and sandstone. Stainless steel models are powder coated for added protection. The color chrome is an available option for stainless steel models only.

INSTALLATION

Surface Mount installation, is designed to be anchored on top of a new or existing surface (concrete, etc.) For a new surface, a surface mount carrier is recommended. For an existing surface, anchor bolts are to be used through the attached mounting plate. Surface Mount Fountains come standard with an access door with vandal resistant stainless steel screws.

WINTERIZATION

Shut off water and drain down. Remove water filter.

WARRANTY

One year warranty, labor not included.

SHIPPING WEIGHT

Model SE 10125 SM.....	110 lbs	Model SE 10125 SMSS.....	100 lbs
Model SE 10140 SMFA.....	150 lbs	Model SE 10140 SMSSFA.....	150 lbs
Model SE 10145 SMFA.....	245 lbs	Model SE 10145 SMSSFA.....	235 lbs
Model SE 10150 SMFA.....	245 lbs	Model SE 10150 SMSSFA.....	235 lbs
Model SE 10155 SMFA.....	195 lbs	Model SE 10155 SMSSFA.....	185 lbs

MOST DEPENDABLE FOUNTAINS, INC.™
 5705 COMMANDER DR. • ARLINGTON, TN 38002-0587
 www.mostdependable.com
 (901) 867-0039



TOP VIEW
scale 1:12

47.875" sq.

ϕ 11.957"
TYP.

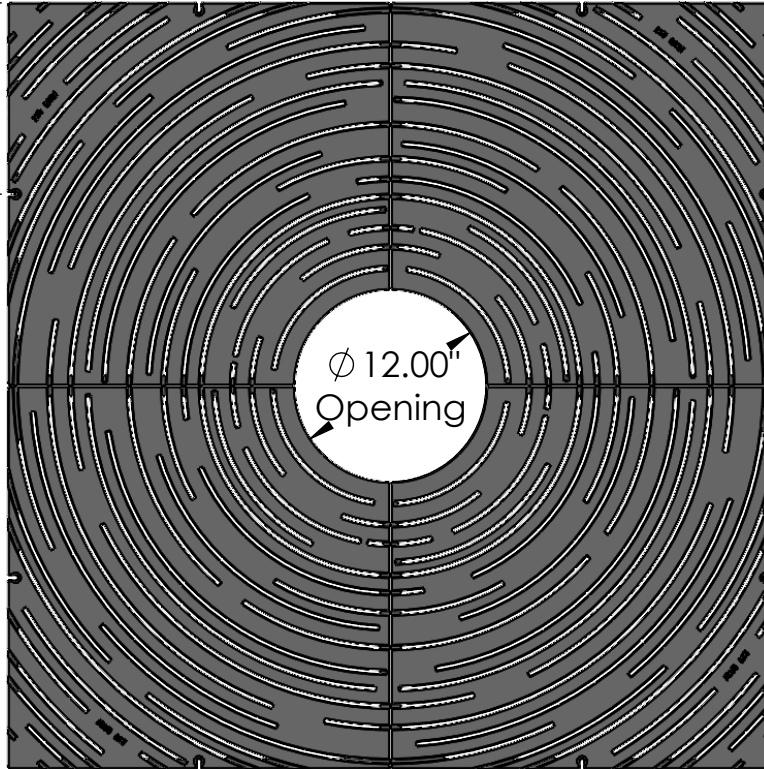

ϕ 12.00"
Opening

CASTING-ID
scale 1:2



1/4"-20 (8x)
Pan Head
STD Bolt

ISO-VIEW
scale 1:18

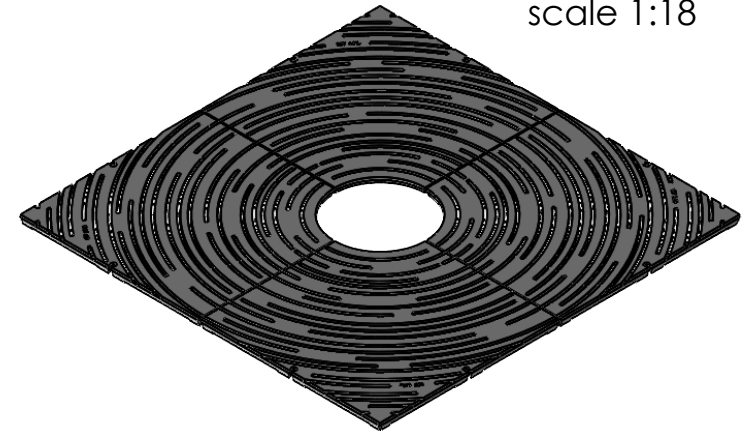

SIDE VIEW
scale 1:12

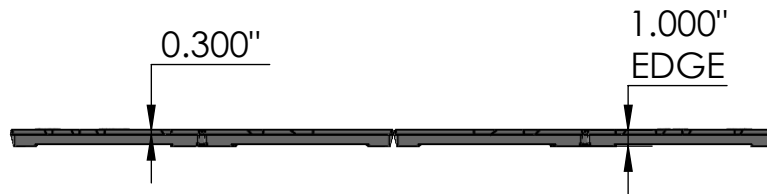

0.300"

1.000"
EDGE

NOTES:

1. Heelproof: No thru openings greater than 1/4".
2. Pieces per Set: 4
3. Due to casting inconsistencies, all dimensions are nominal.
4. Center Opening Options:
Cast at 12", Breakouts at 16" & 20".
5. Pedestrian Load Only.

Made in USA

©2015 Iron Age Designs

Spin 4' x 4' Tree Grate Heel Proof

 IRON AGE DESIGNS Telephone 206.276.0925 www.ironagegrates.com	Material: Ductile Iron 65-45-12 or better	Weight: 212.20 lbs.	Free Drain Area: 374.28 in/sq. or 17.20 %	By: MS Checked: MS Date: 3-26-21
	Finish: Raw	Edge: 1.000"	Flow Rate: 490.31 GPM	© Registration: VA 1-990-504 Scale: NTS
	Fits: Iron Age Custom Frame SOLD SEPARATELY	Product ID: SPX48-48I99TGHP	Drawing Name: 03_SPI_I_48x48HP_TreeGrate_Comp	

TOP VIEW
scale 1:6

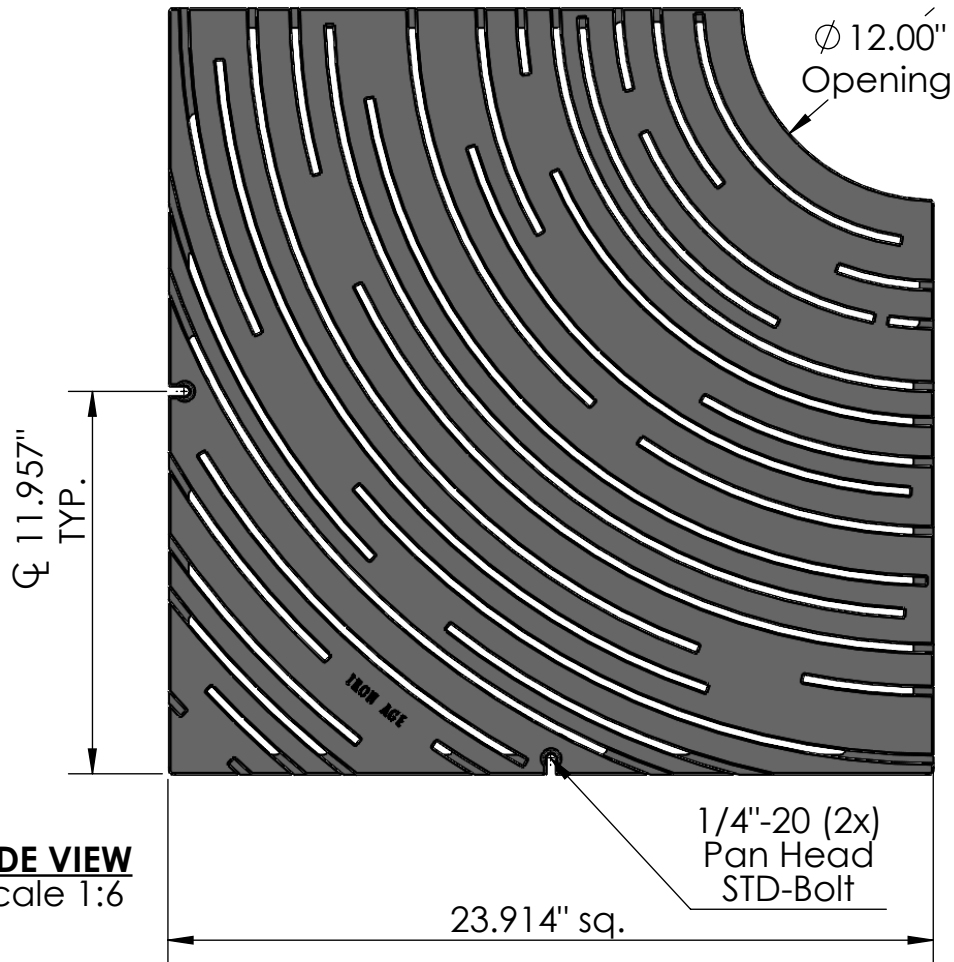

CASTING-ID
scale 1:2



SIDE VIEW
scale 1:6

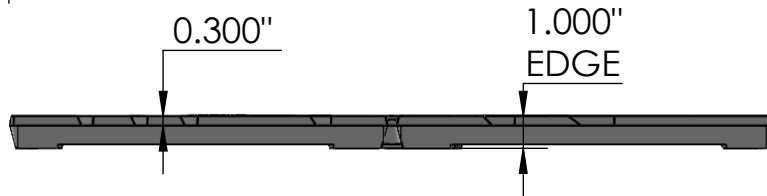

ISO-VIEW
scale 1:8

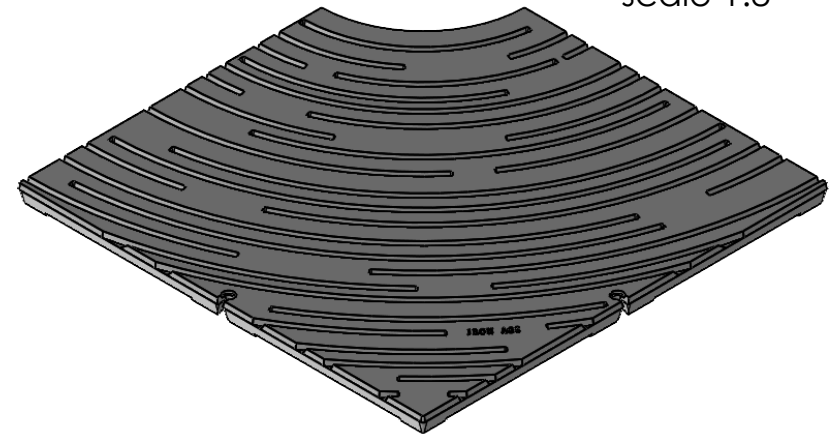

NOTES:

1. Heelprof: No thru openings greater than 1/4".
2. Due to casting inconsistencies, all dimensions are nominal.
3. Pedestrian Load Only.

Made in USA ©2015 Iron Age Designs

Spin 4' x 4' Tree Grate Heel Proof - Quarter Panel

 IRON AGE DESIGNS Telephone 206.276.0925 www.ironagegrates.com	Material: Ductile Iron 65-45-12 or better Finish: Raw Fits: Iron Age Custom Frame SOLD SEPARATELY	Weight: 52.80 lbs. Edge: 1.000" Product ID: SPX48-48I99TGHP	Free Drain Area: 93.57 in/sq. or 17.20 % Flow Rate: 122.57 GPM Drawing Name: 01_SPI_I_48x48HP_TreeGrate	By: MS Checked: MS Date: 3-26-21 © Registration: VA 1-990-504 Scale: NTS
	Page 2			

4984-36B

[Products](#) / [Detectable Warning Plates](#) / [4984-36B](#)

SEARCH ALL PRODUCTS 

VIEW FULL PRODUCT CATALOG

4984-36B

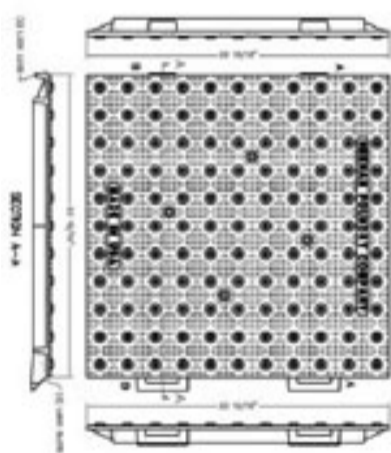

Quick Connect Plates

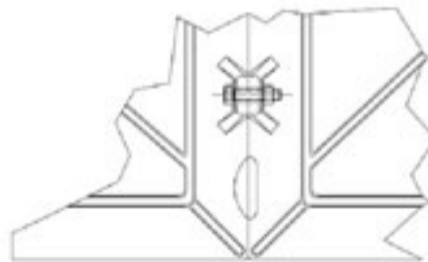

Bolted Plates

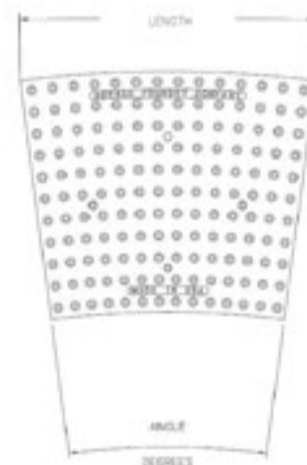

Radius Plates

You may need to scroll horizontally to view all table columns.

Description	Depth x Width	Depth	Radius
Bolted Plates	24" x 36"		

All dimensions are listed in inches unless otherwise noted.

Regulatory-compliant cast iron Detectable Warning Plates from Neenah Foundry offer appealing aesthetics, exceptional longevity and freedom from maintenance. By using Neenah’s Detectable Warning Plates, specifiers can be confident that the critical warning message will be delivered for the lifetime of the installation.

Wears Like Iron Because It Is Iron!

- Lasting form and function — we have never had one fail

- Installations with natural finish are maintenance-free
- Highly resistant to snow plow and shovel damage
- Lasting non-skid properties
- Excellent cast iron to concrete adhesion properties
- No need for replacement features — our plates are permanent
- 5-yr limited warranty
- Vent holes release gasses and air for maximum concrete contact
- Furnished lifting brackets simplify installation
- Can cover long runs using radius or straight sections

Trouble Free Installation

- Plates easily set in wet concrete
- Integral lugs ensure solid attachment
- Cap head screws can be added for extra anchorage

Premium Material

- Low-maintenance cast gray iron
- Excellent wear resistance — virtually indestructible
- Cast iron far outlasts competitive substances
- Natural patina provides ample visual contrast

Guidelines for Accessible Rights-of-Way

The ADA and ABA have specific guidelines that refer to numerous issues concerning detectable warning. Neenah Foundry's Detectable Warning Plates help you meet these requirements.

Neenah recommends that specifiers review prevailing national, state and local guidelines to ensure full compliance.

[REQUEST A CUSTOM QUOTE](#)

[REQUEST MORE INFORMATION](#)

Select Language



[\(/beta/index.php\)](#)[Home \(/Beta/Index.Php\)](#)[About \(/Beta/About.Php\)](#)[Products](#)[Transit \(/Beta/Transit.Php\)](#)[Resources](#)[Distributors](#)[Contact \(/Beta/Contact.Php\)](#)

Cast-In-Place Tactile Panels

The Cast-in-Place panel is a great long term solution for any project or climate. Made with a durable exterior homogenous glass, carbon, and fiberglass reinforced composite material; the thick, heavy panel and sturdy embedment ribs ensure a strong bond and superior structural support.

The Cast in Place Tactile Surface is made of a colorfast and UV stable homogenous glass and carbon composite with fiberglass truncated domes for enhanced durability. The Cast in Place Tactile Surface is used for new curb ramps or new construction applications and is a great long-term solution for any project, under any weather conditions.

All of our truncated dome tactile surfaces are in full compliance with the American Disabilities Act

Accessibility Guidelines (ADAAG), Public Right-of-Way (PROW), and California Title 24 Requirements. ADA Solutions Inc. products are approved for use by all major municipalities, DPWs, and state DOTs.

Features and Advantages

- › For use in new curb ramps or new construction
- › Pressed into place in freshly poured concrete
- › Cast-In-Place Tiles have a 1/4" nominal thickness and feature embedment ribs 3" on center through entire length of tile
- › Plastic sheeting protection covers entire surface of Cast-In-Place Tile
- › Standard sizes: 24" x 36", 24" x 48", 24" x 60", 36" x 48", and 36" x 60"
- › Raised truncated domes with a diameter of nominal 0.9" and a height of 0.2"
- › Body Thickness is 0.25" not including truncated domes
- › Does not rely on any type of paint coating to achieve color stability

Applications

ADA sidewalks are used in public and private spaces throughout the country. They warn pedestrians of changes in surface conditions (e.g., a change from an intersection to a sidewalk or from a sidewalk to a ramp). They also help disabled pedestrians access areas that might otherwise prove too dangerous.

Cast in place truncated domes are specifically designed for new projects such as curb ramps. Install the tactile surface by pressing it into freshly poured concrete. Each detectable warning system features a nominal thickness of 1/4" and centered embedment ribs that

extend 3" along the length of the tile.

Our truncated domes are also UV-, moisture-, and chemical-resistant for maximum durability. Customers can use these sturdy, flexible tactile warnings for a variety of applications to ensure safety and access at any location. Like all of our ADA solutions, our cast in place tactile paving surfaces comply with all local, state, and federal regulations.

Request a quote. We'll give you an accurate estimate and guide you through the ordering process. Need more information first? Want to test our products before purchasing? Contact us to request a sample and speak with a representative.

3-Part Cast-In-Place Product Specification

[DOWNLOAD](#)

Cast-In-Place Pavers Product Brochure

[DOWNLOAD](#)

Cast-In-Place Pavers Product Data Sheet

[DOWNLOAD](#)

Cast-In-Place Installation Instructions

DOWNLOAD

Available Colors

Federal Yellow

Seattle Yellow

Brick Red

Clay Red

Safety Red

Safety Blue

Black

Dark Gray

White

Cast-in-Place Drawings

2436 IDPAV1 (24×36)

[PDF](#)

[DWG](#)

2436 IDPAV2 (24×36)

[PDF](#)

[DWG](#)

2448 IDPAV1 (24×48)

[PDF](#)

[DWG](#)

2448 IDPAV2 (24×48)

[PDF](#)

[DWG](#)

2460 IDPAV1 (24×60)

[PDF](#)

[DWG](#)

2460 IDPAV2 (24×60)

PDF DWG

3648 IDPAV1 (36×48)

PDF DWG

3648 IDPAV2 (36×48)

PDF DWG

3660 IDPAV1 (36×60)

PDF DWG

3660 IDPAV2 (36×60)

PDF DWG

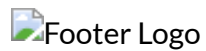

323 Andover Street – Suite 3
Wilmington, MA 01887

CONTACT US

 (800) 372-0519 (toll free) (tel:1-800-372-0519)

 (978) 262-9900 (local) (tel:1-978-262-9900)

 (978) 262-9125

OFFICE HOURS

Monday – Friday: 8 AM – 5 PM

Saturday – Sunday: Closed

HELPFUL LINKS

[Contact Us](#)

[Get a Free Quote](#)

[Find a Distributor](#)

© ADA Solutions, Inc (/ada18/index.php). All Rights Reserved. 



EXHIBIT A
City of Wilsonville

BUS SHELTER EQUIPMENT SPECIFICATIONS

The following equipment is considered one (1) complete bus shelter package:

303.02

Bus Shelter, Hip Roof 4' x 8'

3-sided, Temp glass, Frame: powder coat blue BL-20

Roof: SRI-25 Charcoal Grey GA easy lock

303.02

Trash receptacle, 12" x 24"

Painted Pantone Blue #654

303.02

Bench, 2 seat, 46 ½ x 20 ½ x 23

Surface mount, perforated ¾ rnd, painted: Pantone Green #376

Seat width: 20", Seat height: 18"

732-089-008

Information case, 26¾ x 36 x 2

Bus shelter, stainless steel, cork board, tempered glass,

2 locks top/bottom, rubber seal, keyed alike

BUS SHELTER - 4' X 8'



PRODUCT
P1710-0255
 BUS SHELTER, HIP ROOF, 4X8, 3 SIDED, TEMP GLASS,
 FRAME AND ROOF PAINTED

SIZE: Product Master



Oregon Corrections
 ENTERPRISES
 P.O. BOX 12849
 SALEM, OR 97309
 PH: (503) 378-5276

NOTICE: THIS DRAWING IS PROPERTY OF OREGON CORRECTIONS ENTERPRISES AND CONTAINS INFORMATION THAT IS NOT TO BE USED EXCEPT IN CONSIDERATION OF BIDS OR PROPOSALS TENDERED HEREWITH. REPRODUCTION OR COPYING OF THIS DRAWING, IN WHOLE OR IN PART IS PROHIBITED.

APPROVED
 6/24/2017
 FOR
 PRODUCTION

DRAWN BY: T. Wilson
 DATE DRAWN: 6/28/2017
 MODEL FILE: X
 DRAWING NO.: MS1017-0002
 TOLERANCE: ± 1/16" (UNO)
 SHEET 1 OF 12

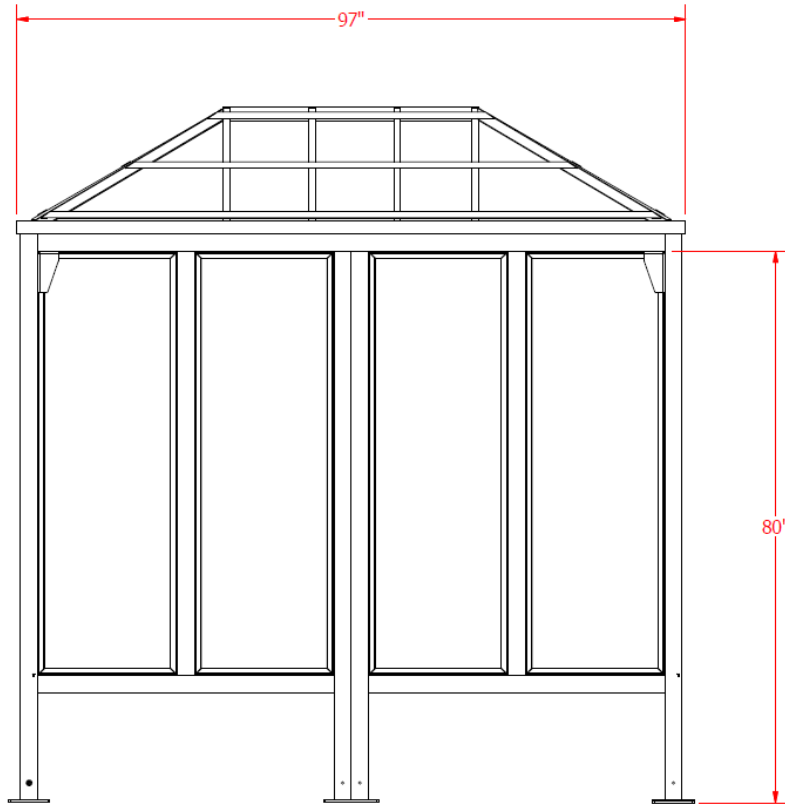
CONCEPTUAL DRAWING FOR CUSTOMER SIGN OFF ONLY, NOT INTENDED FOR PRODUCTION
 Please provide comment on conceptual drawing, mark appropriate box below, provide authorized signature and fax to 608-378-1088
 No Exceptions Noted Revise & Re-Submit
 X
 Signature _____ Date _____



FRONT VIEW
SCALE: 1/16"=1"

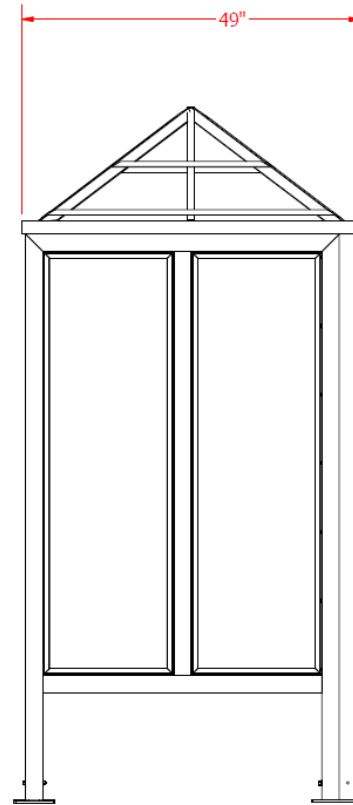

SIDE VIEW
SCALE: 1/16"=1"

PRODUCT

P1710-0255

BUS SHELTER, HIP ROOF, 4X8, 3 SIDED, TEMP GLASS,
FRAME AND ROOF PAINTED

SIZE: Product Master



Oregon Corrections
ENTERPRISES

P.O. BOX 12849
SALEM, OR 97309

PH: (503) 378-5276

NOTICE: THIS DRAWING IS
PROPERTY OF OREGON
CORRECTIONS ENTERPRISES AND
CONTAINS INFORMATION THAT IS
NOT TO BE USED EXCEPT IN
CONSIDERATION OF BIDS OR
PROPOSALS TENDERED HEREWITH.
REPRODUCTION OR COPYING OF
THIS DRAWING, IN WHOLE OR IN
PART IS PROHIBITED.

DRAWN BY T. Wilson

DATE DRAWN 0/28/2017

MODEL FILE X

DRAWING NO. MS1017-0002

TOLERANCE: ± 1/16" (UNO)

SHEET 2 OF 12

* MATERIAL *
SHEET STEEL 16GA. CR.

MOUNTING HARDWARE PROVIDE BY OTHER



TOP VIEW
SCALE: 1 / 4

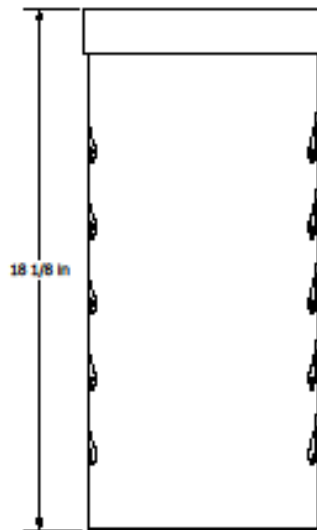

FRONT VIEW
SCALE: 1 / 4

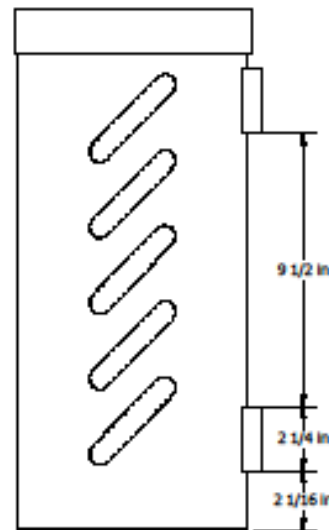

SIDE VIEW
SCALE: 1 / 4

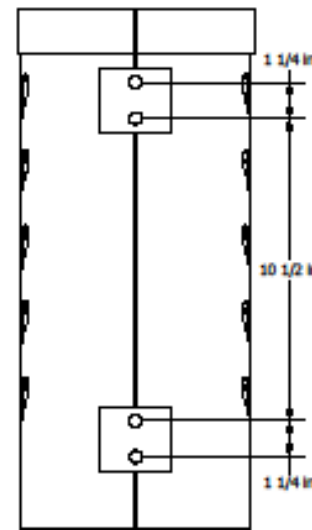

BACK VIEW
SCALE: 1 / 4

**OREGON
CORRECTIONS
ENTERPRISES**
P.O. BOX 12849
SALEM, OR 97309
PH: (503) 378-5276

NOTICE: THIS DRAWING IS
PROPERTY OF OREGON
CORRECTIONS ENTERPRISES AND
CONTAINS INFORMATION THAT IS
NOT TO BE USED EXCEPT IN
CONNECTION WITH THE
PROPOSALS TENDERED HEREBY.
REPRODUCTION OR COPYING OF
THIS DRAWING, IN WHOLE OR IN
PART IS PROHIBITED.

BUS SHELTER TRASH RECEPTACLE
8IN DIA. X 18IN H.

DESIGNED BY	DATE
TX	5/6/2016
CHECKER	DATE
	11/17/2015
APPROVAL	DATE
	11/17/2015

SUBMITTED
05/05/2016
FOR APPROVAL

CONCEPTUAL DRAWING FOR CUSTOMER
SEEK OFF ONLY, NOT INTENDED FOR PRODUCTION
Please provide comment on conceptual
drawing, mark appropriate here below,
provide authorized signature and fee to 503-378-5276

No Exceptions Noted
 Revise & Re-Submit

X _____
Signature Date

PROJECT NO.	REV
BUS SHELTER	
PROJECT NO.	REV
P1605-0071	
DRAWING NO.	REV
MS0515-0011	
SCALE	REV
1/16" = 1"	A
SHEET	REV
1 OF 8	

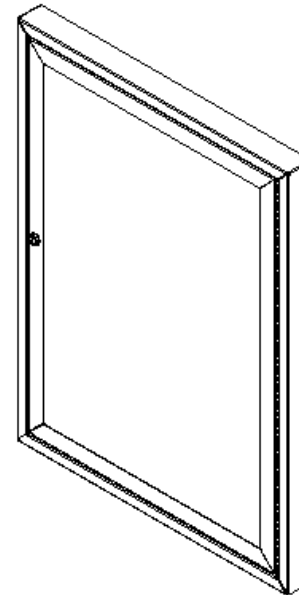
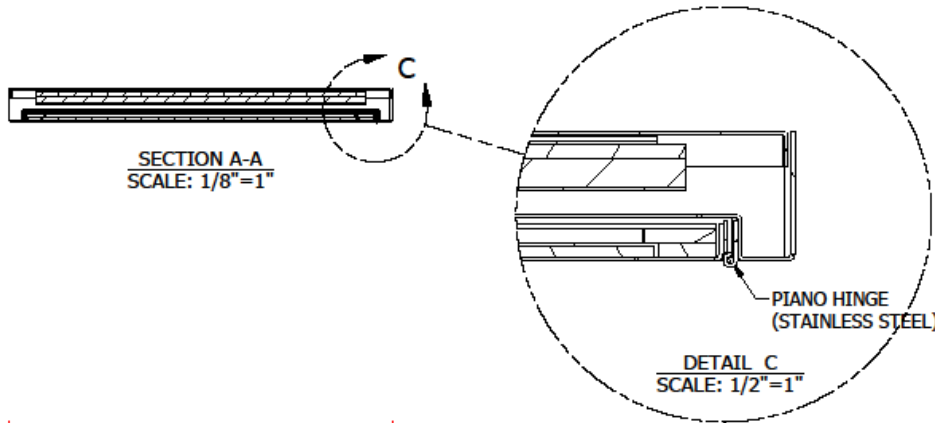

PERSPECTIVE VIEW
SCALE: 1/8"=1"

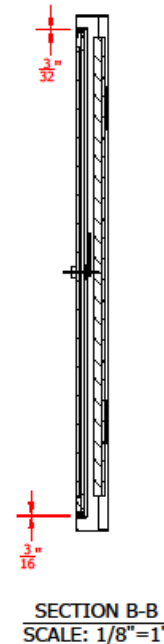
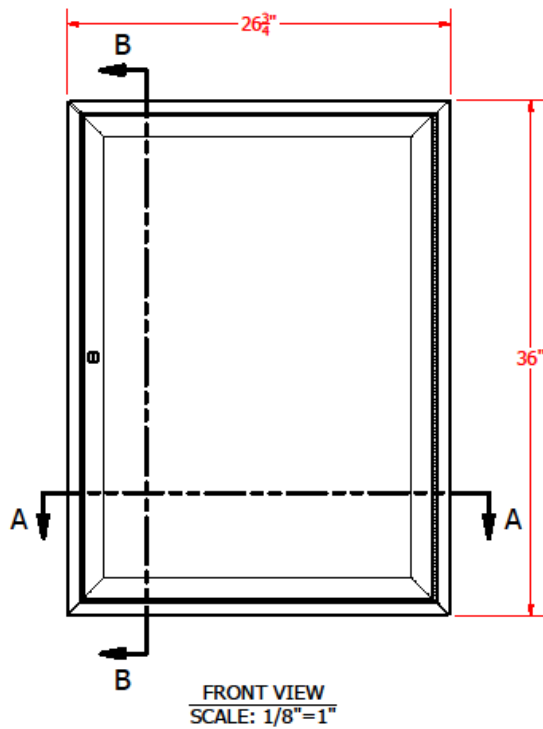

CONCEPTUAL DRAWING FOR CUSTOMER
SIGN OFF ONLY, NOT INTENDED FOR PRODUCTION

Please provide comment on conceptual drawing, mark appropriate box below, provide authorized signature and fax to 603-873-1088

No Exceptions Noted

Revise & Re-Submit

Signature _____ Date _____

**OREGON
CORRECTIONS
ENTERPRISES**

P.O. BOX 12849
SALEM, OR 97309

PH: (503) 378-5276

NOTICE: THIS DRAWING IS PROPERTY OF OREGON CORRECTIONS ENTERPRISES AND CONTAINS INFORMATION THAT IS NOT TO BE USED EXCEPT IN CONSIDERATION OF BIDS OR PROPOSALS TENDERED HEREWITH. REPRODUCTION OR COPYING OF THIS DRAWING, IN WHOLE OR IN PART IS PROHIBITED.

DISPLAY CASE

DRAWN BY T. WILSON	DATE 10/19/2016
CHECKED BY	DATE
APPROVED BY	DATE
DRAWING STATUS	

MODEL FILE	
PRODUCT NO. 732-090-008	
DRAWING NO. MS0316-0024	
SCALE: (UNO) 1/16" = 1"	REV: A
SHEET 1	OF 11

29599 SW Brown Rd
Wilsonville, Oregon



Google

Street View

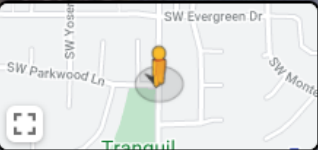

Google

